



Kraljevo, Srbija
++381 36 362 739
++381 60 362 739 0
++381 60 036 036 2
pekomregali@gmail.com
office@pekom.rs
info@pekom.rs
www.pekom.rs



„Mi smo porodično preduzeće, a ne deoničarko društvo. Fokusirani smo na dugoročni i održivi razvoj našeg preduzeća. Mi smo mali i fleksibilni. Možemo brzo da odlučujemo. U stanju smo da pratimo zacrtani put i prebrodimo veće probleme.

Već dugo godina imamo veoma efikasno preduzeće. Uvek smo se prilagođavali novim vremenima. Kada su se menjale potrebe tržišta i tehnologije, mi smo išli uvek korak sa vremenom, razvijali smo nove proizvode. To je ta tajna uspeha, to je ono što je presudno.

Naša MISIJA je da gradimo na osnovama prepoznatljivog kvaliteta, da razvijamo, proizvodimo i plasiramo na tržište najkvalitetnije nosače kablova koje našim potrošačima pružaju laku montažu, dobar kvalitet i konkurentnu cenu.

Nasa VIZIJA je da izrastemo iz lokalnog u Evropskog lidera u proizvodnji nosača kablova.”

MARKO PEKOVIĆ, dipl. maš. ing.
DIREKTOR



We are a family company, instead of a stock company. Our focus lies on a long-term and sustainable development of our company. We are small and flexible. And quick in making decisions. We are capable of following our planned trajectory and overcoming of large problems.









Our company is very efficient for many years. We always successfully adopted to new times. We have always able to keep up with the new times and we developed new products, when needs of the market changed and when technologies were improved. That's the secret of our success, that's crucial.

Our mission is to built on the basis of recognizable quality, to develop, manufacture and place to the market the best quality cable tray systems, that provide easy mounting, good quality and competitive prices to our customers.

Our VISION is to grow from the local to the European leader in the production of cable trays systems and adds.

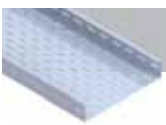
MARKO PEKOVIĆ, dipl. maš. ing.
DIRECTOR



- | | | | | |
|---|---|------|--|---------|
| 1 |  | MS | MONTAŽNI SISTEMI
MOUNTING SYSTEMS | 4-19 |
| 2 |  | PNK | PERFORIRANI NOSAČI KABLOVA
PERFORATED CABLE TRAY SYSTEMS
H30 H50 H60 H85 H110 POK | 20-69 |
| 3 |  | LNK | LESTVIČASTI NOSAČI KABLOVA
LADDER CABLE TRAY SYSTEMS
H50 H60 H110 | 70-93 |
| 4 |  | MNK | MREŽASTI NOSAČI KABLOVA
MESH CABLE TRAY SYSTEMS
H55 H105 | 94-101 |
| 5 |  | E90 | E90 - VATROOTPORNI NOSAČI KABLOVA
E90 - FIREPROOF CABLE TRAY SYSTEMS
H50 H60 | 102-107 |
| 6 |  | NZR | NOSAČI KABLOVA ZA RASVETU
CABLE TRAY SYSTEMS FOR LIGHTING | 108-115 |
| 7 |  | INOX | NOSAČI KABLOVA OD INOX-A
STAINLESS STEEL CABLE TRAY SYSTEMS
V2A V4A | 116-133 |
| 8 |  | CR | PLASTIFICIRANI NOSAČI KABLOVA
PLASTIFICIZED CABLE TRAY SYSTEMS | 134-145 |
| 9 |  | PS | PRIČVRSNI SISTEMI
FASTENING SYSTEMS | 146-154 |

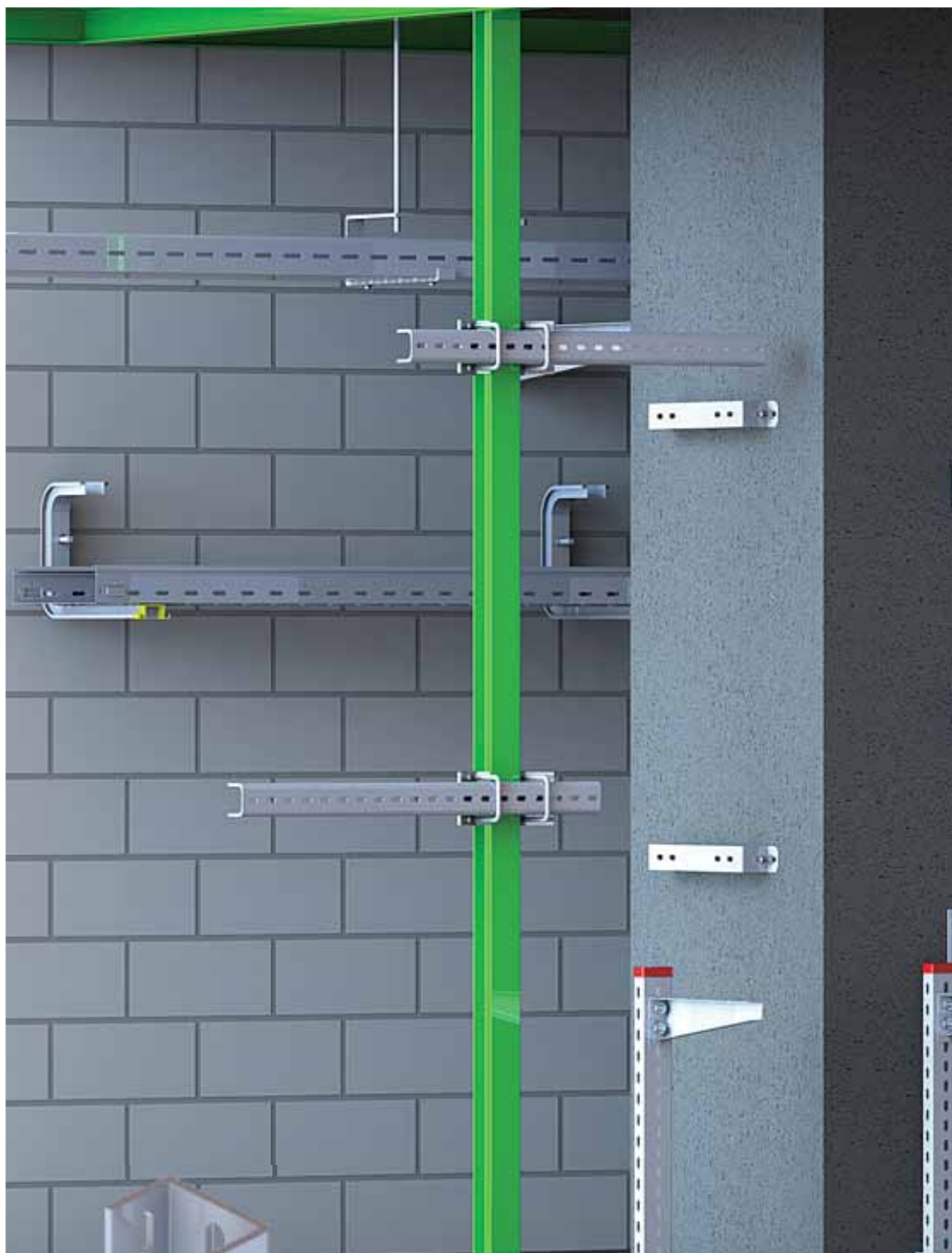

MS

1

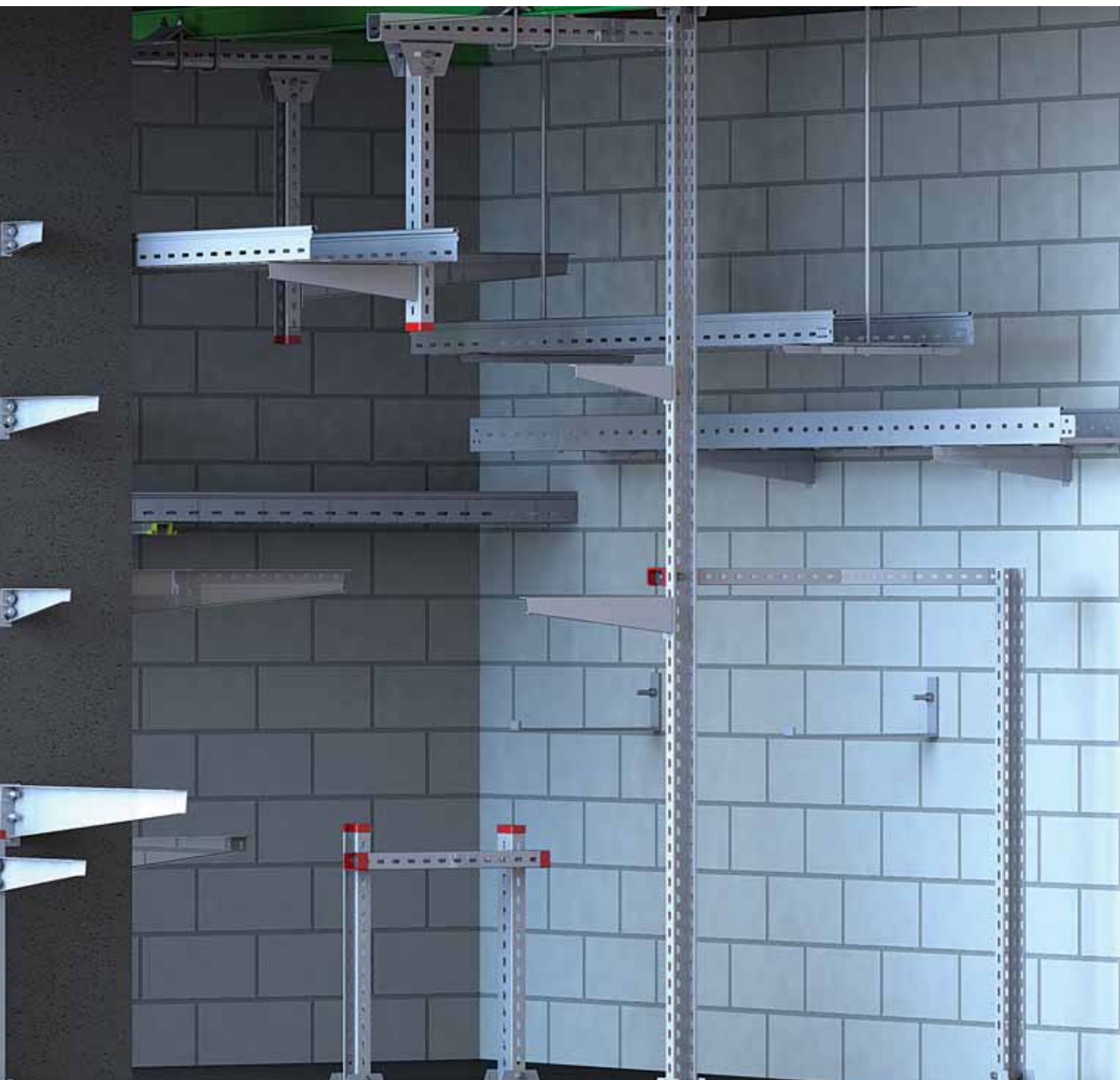

MONTAŽNI SISTEMI

MOUNTING SYSTEMS



1

Montaža na „I“ profil pomoću dve navojne šipke. Na slici je prikazan princip montaže na „I“ profil. Veza između „I“ profila i navojne šipke ostvarena je pomoću montažne stege tipa TKL M10. Dalja veza između profilne šine i navojne šipke ostvaruje se pomoću šestougaone matice tipa PEKOM. Veza između regala i profilne šine ostvarena je vijcima tipa PEKOM M6 x 12.

Mounting the cable trays to the „I“ profile by two threaded rods. The photo shows the principle of the mounting cable trays to „I“ profile. The connection between „I“ profile and the threaded rod is made by assembly steg, type PKL M10. And the connection between threaded rod and profile rail is made hexagon PEKOM type nut. The connection between profile rail and cable trays is made by using PEKOM torch bolts, type M6 x 12.



2

Montaža U profila na ravan plafon. Kod montaže U profila koristi se UD nosač. UD nosač se montira na plafon anker vijcima tipa FAZ II. U profil za UD nosač pričvršćuje se sa 4 torban vijka, tipa PEKOM M8 x 16. Odstojnik U stuba koristi se za povećanje stabilnosti prilikom pričvršćivanja U profila za UD nosač. Za montažu konzola na U stub koriste se 2 torban vijka tipa PEKOM M8 x 16.

Mounting „U“ profile against the flat ceiling. When mounting „U“ profile, we use „UD“ carrier. „UD“ carrier is mounted against the ceiling by using anchor screws, type FAZ II. The connection between „UD“ carrier and „U“ profile is made by using 4 PEKOM torch bolts, type M8 x 16. The U-pillar spacer is used to increase the stability when fastening „U“ profile to the „UD“ carrier. For mounting cantilevers against „U“ profile we use 2 PEKOM torch bolts, type M8 x 16.



3

Montaža pomoću jedne navojne šipke i profilne šine. Navojna šipka se u plafon ugrađuje pomoću čeličnog tipla EA II. Veza između navojne šipke i profilne šine ostvaruje se putem šestougaone matice tipa PEKOM. Spoj između regala i profilne šine ostvaruje se pomoću vijaka tipa PEKOM M6 x 12.

Mounting the cable trays by a threaded rod and a profile rail. Threaded rod is built in the ceiling, by using steel anchor, type EA II. The connection between threaded rod and profile rail is made hexagon PEKOM type nut. The connection between profile rail and cable trays is made by using PEKOM torch bolts, type M6 x 12.

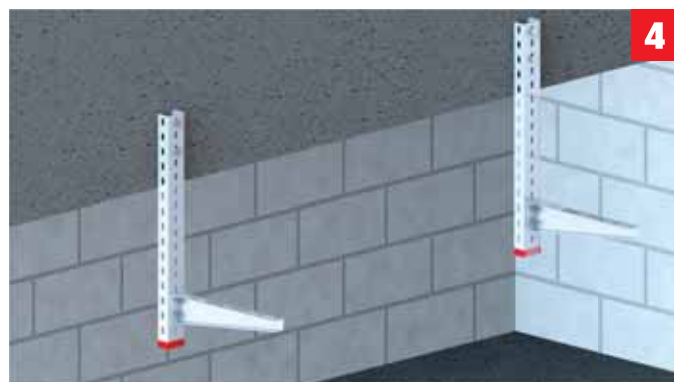

4

„U“ stub na horizontalnoj gredi. „U“ profil koristi se za vertikalnu montažu, sa horizontalne grede u ovom primeru. Za pričvršćivanje „U“ stuba za horizontalnu gredu koriste se vijci tipa FAZ II. Veza između konzole i „U“ stuba otvorena je korišćenjem 2 torban vijka tipa PEKOM M8 x 16.

U pillar against the horizontal beam. In this example U pillar is used for the vertical mounting against the horizontal beam. We use anchor screws, type FAZ II, for attaching U pillar to the horizontal beam. The connection between cantilever and the U pillar is made by using 2 PEKOM torch bolts, type M6 x 12.



5

Plafonski „G“ nosač. Služi za montažu nosača direktno na plafon, kao i za spuštanje sa plafona navojnom šipkom. U ovom slučaju na „G“ nosač postavljen je PNK regal sa Master spojnicom. Za pričvršćivanje na plafon koristi se anker vijak tipa FAZ II. Pričvršćivanje regala za „G“ nosač, obezbeđeno je pomoću vijaka tipa PEKOM M6 x 12. Plafonski „G“ nosač koristi se na mestima gde po visinama ima jako malo prostora za montažu.

G carrier for ceilings. It is used for mounting carrier to the ceilings, as well as for the descending from the ceiling by threaded rod. In this case PNK cable tray is attached to the carrier by Master click system. We use anchor screw, type FAZ II, for mounting G carrier to the ceiling. Attaching PNK cable tray to a G carrier is done by PEKOM torch bolts, type M6 x 12. G carrier for ceilings is used on the places where we do not have enough space for height mounting.



6

Princip montaže profilne šine pomoću dve navojne šipke. Plafonski „C“ nosač služi za vezivanje navojne šipke za plafon. Na navojne šipke postavlja se profilna šina namenjena za dve navojne šipke. Veza između navojne šipke i profilne šine ostvaruje se putem šestougaone matice tipa PEKOM. Veza između regala i profilne šine ostvaruje se putem vijaka tipa PEKOM M6 x 12.

The principle of mounting profile rail by using two threaded rods. C carrier for ceiling is used to attach threaded rods to the ceiling. We attach profile rail to the threaded rods. The connection between threaded rods and profile rail is made by using hexagon PEKOM type nut. The connection between profile rail and cable trays is made by using PEKOM torch bolts, type M6 x 12.



7

Montaža regala na trapezni plafon. Nosač za trapezni plafon služi za pričvršćivanje regala na standardne trapezne plafone. Veza između trapeznog nosača i plafona vrši se mašinskim vijkom M8 x 120. Nosač na sebi ima integrisanu maticu sa navojem pomoću koje se ostvaruje jednostavna montaža navojne šipke.

Mounting the cable tray to the trapezoid ceiling. Carrier for trapezoid ceiling is used for attaching PNK cable tray to the standard trapezoid ceiling. The connection between the carrier and the trapezoid ceiling is made by PEKOM screw, type M8x120. There is integrated threaded nut on the carrier, which makes it simple to mount threaded rod.



8

PNK na jedno-navojnoj šipki. Navojna šipka ugrađuje se u plafon, korišćenjem čeličnog tipla tipa EA II. Navojna šipka se direktno vezuje za regal pomoću šestougaone matice. Ovaj način montaže se koristi kada su opterećenja mala. Prilikom montaže treba se voditi računa da se ravnomerno raspoređi opterećenje.

PNK cable tray against one threaded rod. Threaded rod is built in the ceiling, by using steel anchor, type EA II. Cable tray is attached to the threaded rod by using hexagon PEKOM type nut. We use this type of mounting on small loads. When assembling, we must make sure to distribute the load evenly.



9

Montaža U profila na ravan plafon. Kod montaže U profila koristi se UD nosač. UD nosač se montira na plafon anker vijcima tipa FAZ II. U profil za UD nosač pričvršćuje se sa 4 torban vijka, tipa PEKOM M8 x 16. Odstojnik U stuba koristi se za povećanje stabilnosti prilikom pričvršćivanja U profila za UD nosač.

Mounting "U" profile against the flat ceiling. When mounting "U" profile, we use „UD" carrier. „UD" carrier is mounted against the ceiling by using anchor screws, type FAZ II. The connection between „UD" carrier and "U" profile is made by using 4 PEKOM torch bolts, type M8 x 16. The U-pillar spacer is used to increase the stability when fastening "U" profile to the „UD" carrier.

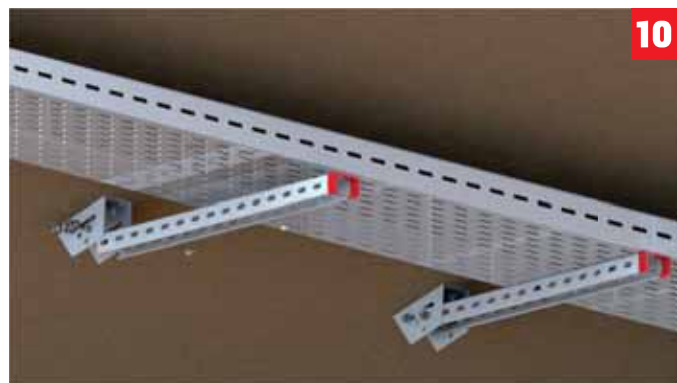

10

Montaža nosača na kosom zidu. „UD" nosač se montira na kosi zid anker vijcima tipa FAZ II. Maksimalan ugao zakretanja „U" profila iznosi 30°. Spoj između „UD" nosača i „U" profila ostvaruje se pomoću 4 torban vijka, tipa PEKOM M8 x 16. Veza između regala i „U" stuba ostvaruje se pomoću vijka tipa PEKOM M6 x 12.

Mounting the cable tray against the sloping wall. „UD" carrier is mounted against the sloping wall by anchor screws, type FAZ II. The maximum angle of rotation of the "U" profile is 30°. The connection between „UD" carrier and "U" profile is made by using 4 PEKOM torch bolts, type M8 x 16. The connection between the cable tray and the "U" profile is made by using PEKOM torch bolts, type M6 x 12.



11

Izrada podkonstrukcije od „U" profila. Kod izrade podkonstrukcije od „U" profila za pričvršćivanje na plafon koristi se „UD" nosač. „UD" nosač se montira na plafon anker vijcima tipa FAZ II. Za „UD" nosač pričvršćuje se „U" profil sa 4 torban vijka, tipa PEKOM M8 x 16. Za poprečnu vezu koristi se standardni „U" profil, koji se za vertikalne „U" profile vezuje torban vijcima tipa PEKOM M8 x 16.

Making the sub construction by using "U" profiles. When we are making the sub construction by using "U" profiles, we use „UD" carrier for fastening it to the ceiling. „UD" carrier is mounted against the ceiling by using anchor screws, type FAZ II. "U" profile is attached to the UD carrier by using 4 PEKOM torch bolts, type M8 x 16. In order to connect vertical "U" profiles we use standard "U" profile for cross-link, attaching them by using PEKOM torch bolts, type M8 x 16.



12

Montaža U profila na I profil. Veza između I profila i U profila ostvarena je pomoću montažne steg tipa TKR 42. Na U profil montiran je UD nosač na koji se montira U profil pomoću torban vijka tipa PEKOM M8 x 16. Odstojnik U stuba koristi se za povećanje stabilnosti prilikom pričvršćivanja U profila za UD nosač. Za montažu konzola na U stub koriste se 2 torban vijka tipa PEKOM M8 x 16.

Mounting "U" profile to "I" profile. The connection between "U" profile and "I" profile is made by assembly steg, type TKR 42. There is „UD" carrier fastened to "U" profile. And then we fasten "U" profile to the „UD" carrier, by using PEKOM torch bolts, type M8 x 16. The U-pillar spacer is used to increase the stability when fastening "U" profile to the „UD" carrier. For mounting cantilevers against "U" profile we use 2 PEKOM torch bolts, type M8 x 16.



13

Montaža nosača na kosom zidu. UD nosač se montira na kosi zid anker vijcima tipa FAZ II. Maksimalan ugao zakretanja U profila iznosi 30°. Spoj između UD nosača i U profila ostvaruje se pomoću 4 torban vijka, tipa PEKOM M8 x 16. Za montažu konzola na U stub koriste se 2 torban vijka tipa PEKOM M8 x 16.

Mounting the cable tray against the sloping wall. „UD” carrier is mounted against the sloping wall by anchor screws, type FAZ II. The maximum angle of rotation of the “U” profile is 30°. The connection between “UD” carrier and “U” profile is made by using 4 PEKOM torch bolts, type M8 x 16. For mounting cantilevers against “U” profile we use 2 PEKOM torch bolts, type M8 x 16.



14

„C” nosač. Plafonski „C” nosač služi za vezivanje navojne šipke za plafon. U ovom slučaju na „C” nosaču i jednoj navojnoj šipki, prikačen je PNK regal sa Master spojnicom. Veza između regala i „G” nosača ostvarena je vijcima tipa PEKOM M6 x 12.

C carrier for ceilings. It is used for attaching threaded rod to the ceilings. In this case PNK cable tray is attached to a threaded rod and the C carrier by the Master click system. The connection between PNK cable tray and the C carrier is made by PEKOM torch bolts, type M6 x 12.



15

Montaža U profila na I profil. Veza između I profila i U profila ostvarena je pomoću montažne stege tipa TKR 42.

Mounting “U” profile to “I” profile. The connection between “U” profile and “I” profile is made by assembly steg, type TKR 42.

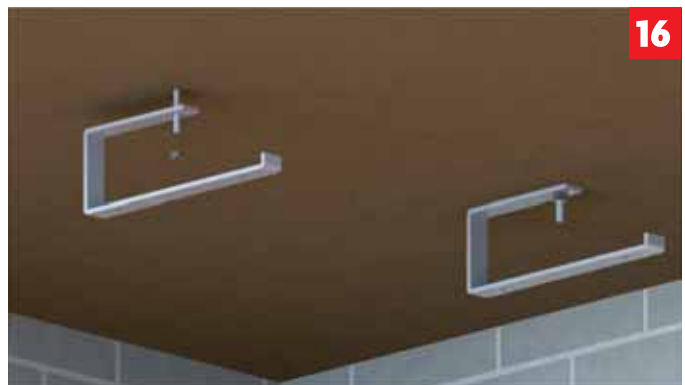

16

Plafonski „G” nosač. Na primeru dat je prikaz montaže „G” nosača na plafon. Za pričvršćivanje nosača na plafon koristi se anker vijak tipa FAZ II.

G carrier for ceilings. Here is an example for mounting G carrier to the ceilings. We use an anchor screw, type FAZ II, for mounting G carrier to the ceiling.



17

Montaža konzole direktno na zid. Za montažu konzole direktni na zid koristi se anker vijak tipa FBN II. Na konzolu se postavljaju regali koji se učvršćuju torban vijcima tipa PEKOM 6x12mm.

Mounting cantilever directly to the wall. For mounting the cantilever directly to the wall, we use anchor screws, type FBN II. We place PNK cable trays against the cantilever, fastening them by using PEKOM torch bolts, type M6 x 12.



18

Montaža središnjeg nosača. Posедуje na sebi poseđuje integrisnu maticu za montažu navojne šipke na sam nosač. Prilikom montaže potrebno je obratiti pažnju na ravnomernu raspodelu opterećenja.

Mounting the central carrier. There is integrated nut on the central carrier for mounting threaded rod to the carrier. When assembling, we must make sure to distribute the load evenly.



19

Montaža regala na pod pomoću omega nosača. Montaža omega nosača na pod vrši se anker vijcima tipa FBN II. Za povezivanje regala na omega nosač koriste se torban vijci tipa PEKOM M6 x 12.

Mounting cable tray to the floor by spacer. Mounting the spacer to the floor is made by anchor screws, type FBN II. We use PEKOM torch bolts, type M6 x 12, for mounting PNK cable tray to the spacer.



20

Montaža omega nosača na zid. Montaža omega nosača na zid vrši se anker vijcima tipa FBN II. Za povezivanje regala na omega nosač koriste se torban vijci tipa PEKOM M6 x 12.

Mounting spacer against the wall. Mounting the spacer against the wall is made by using anchor screws, type FAZ II. For fastening cable carriers against the spacer, we use PEKOM torch bolts, type M6 x 12.

Plafonski UD nosač / UD carrier for ceilings

MS

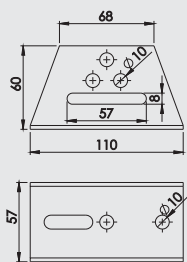

Tip Typ	Debljina Thickness	Nosivost Load	Pakovanje Pack kom piece	Šifra artikla Article
	mm	kg		PL
UD U5 PL	2	611	10	30010001
				TC
UD U5 TC	2	611	10	30020001

PL Pocinkovani lim / Galvanized sheet **TC** Toplo pocinkovano potapanjem / Hot - dip galvanized



Montažni sistemi

U profil / U profile

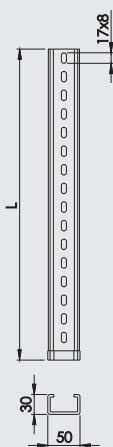

Tip Typ	Dužina L Length L	Dimenzije Dimensions	Debljina Thickness	Pakovanje Pack kom piece	Šifra artikla Article
	mm	mm	mm		PL
U 5 20 PL	200	50x30	2	10	30010002
U 5 30 PL	300	50x30	2	10	30010003
U 5 40 PL	400	50x30	2	10	30010004
U 5 50 PL	500	50x30	2	10	30010005
U 5 60 PL	600	50x30	2	6	30010006
U 5 70 PL	700	50x30	2	6	30010007
U 5 80 PL	800	50x30	2	6	30010008
U 5 90 PL	900	50x30	2	6	30010009
U 5 100 PL	1000	50x30	2	4	30010010
U 5 150 PL	1500	50x30	2	4	30010011
U 5 200 PL	2000	50x30	2	4	30010012
U 5 300 PL	3000	50x30	2	4	30010059
					TC
U 5 20 TC	200	50x30	2	10	30020002
U 5 30 TC	300	50x30	2	10	30020003
U 5 40 TC	400	50x30	2	10	30020004
U 5 50 TC	500	50x30	2	10	30020005
U 5 60 TC	600	50x30	2	6	30020006
U 5 70 TC	700	50x30	2	6	30020007
U 5 80 TC	800	50x30	2	6	30020008
U 5 90 TC	900	50x30	2	6	30020009
U 5 100 TC	1000	50x30	2	4	30020010
U 5 150 TC	1500	50x30	2	4	30020011
U 5 200 TC	2000	50x30	2	4	30020012
U 5 300 TC	3000	50x30	2	4	30020059

PL Pocinkovani lim / Galvanized sheet **TC** Toplo pocinkovano potapanjem / Hot - dip galvanized

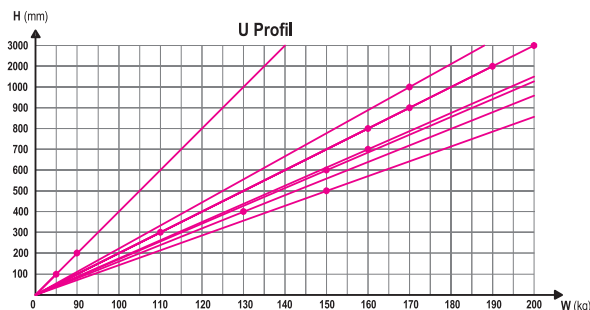

Spojnica U stuba / U pillar clip

MS

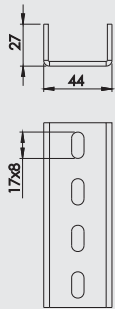

Tip Typ	Dužina L Length L	Debljina Thickness	Pakovanje Pack kom piece	Šifra artikla Article
S U5 PL	200	2	10	PL 30010013
S U5 TC	200	2	10	TC 30020013

PL Pocinkovani lim / Galvanized sheet

TC Toplo pocinkovano potapanjem / Hot - dip galvanized



Konzola / Cantilever

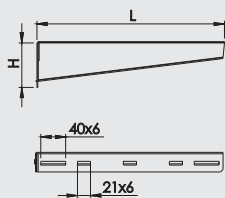

Tip Typ	Dužina Length L	Visina Height H	Debljina Thickness D	Nosivost Load kg	Pakovanje Pack kom piece	Šifra artikla Article
KZ PNK 50 PL	50	60	2	129	10	PL 30010015
KZ PNK 100 PL	100	60	2	130	10	30010016
KZ PNK 160 PL	160	60	2	131	10	30010017
KZ PNK 200 PL	200	60	2	132	10	30010018
KZ PNK 300 PL	300	60	2	128	10	30010019
KZ PNK 400 PL	400	60	2	126	10	30010020
KZ PNK 500 PL	500	93	2	121	10	30010021
KZ PNK 600 PL	600	93	2	118	10	30010022
						TC
KZ PNK 50 TC	50	60	2	129	10	30020015
KZ PNK 100 TC	100	60	2	130	10	30020016
KZ PNK 160 TC	160	60	2	131	10	30020017
KZ PNK 200 TC	200	60	2	132	10	30020018
KZ PNK 300 TC	300	60	2	128	10	30020019
KZ PNK 400 TC	400	60	2	126	10	30020020
KZ PNK 500 TC	500	93	2	121	10	30020021
KZ PNK 600 TC	600	93	2	118	10	30020022

PL Pocinkovani lim / Galvanized sheet

TC Toplo pocinkovano potapanjem / Hot - dip galvanized

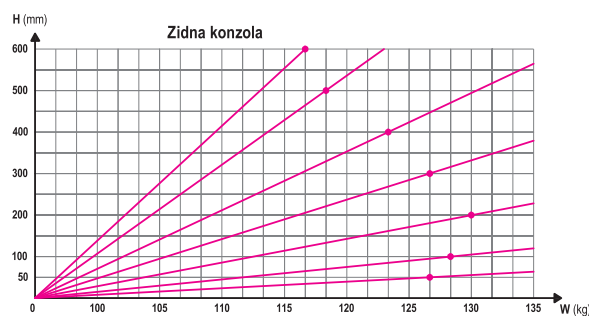

Konzola sa navarenom pločom / Cantilever with welded plate

MS

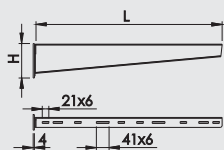

Tip Typ	Dužina L Length L mm	Visina Height H mm	Debljina Thickness mm	Nosivost Load kg	Debljina ploče Plate thickness mm	Pakovanje Pack kom piece	Šifra artikla Article PL
KZP PNK 50 PL	50	80	2	345	4	10	30010064
KZP PNK 100 PL	100	80	2	350	4	10	30010065
KZP PNK 160 PL	160	80	2	330	4	10	30010066
KZP PNK 200 PL	200	80	2	330	4	10	30010067
KZP PNK 300 PL	300	80	2	320	4	10	30010068
KZP PNK 400 PL	400	110	2	320	4	10	30010069
KZP PNK 500 PL	500	110	2	320	4	10	30010070
KZP PNK 600 PL	600	110	2	320	4	10	30010071
							TC
KZP PNK 50 TC	50	80	2	345	4	10	30020064
KZP PNK 100 TC	100	80	2	350	4	10	30020065
KZP PNK 160 TC	160	80	2	330	4	10	30020066
KZP PNK 200 TC	200	80	2	330	4	10	30020067
KZP PNK 300 TC	300	80	2	320	4	10	30020068
KZP PNK 400 TC	400	110	2	320	4	10	30020069
KZP PNK 500 TC	500	110	2	320	4	10	30020070
KZP PNK 600 TC	600	110	2	320	4	10	30020071

PL Pocinkovani lim / Galvanized sheet **TC** Toplo pocinkovano potapanjem / Hot - dip galvanized

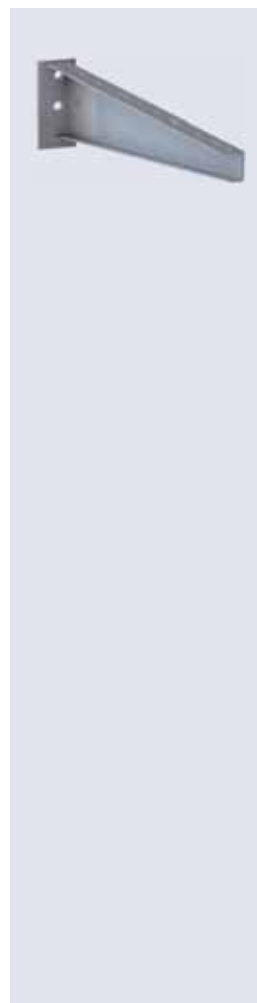
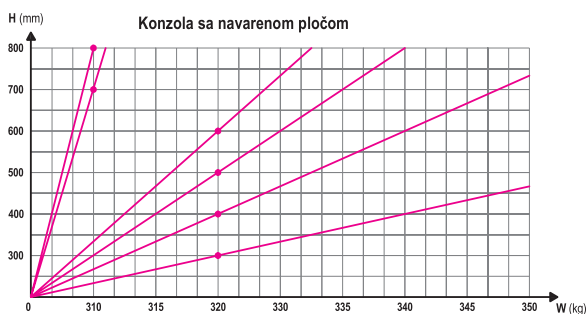

Montažni sistemi

Odstojnik za U stub / Spacer for U pillar

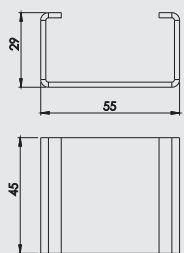

Tip Typ	Debljina Thickness mm	Pakovanje Pack kom piece	Šifra artikla Article PL
OD U5 PL	2	10	30010014
			TC
OD U5 TC	2	10	30020014

PL Pocinkovani lim / Galvanized sheet **TC** Toplo pocinkovano potapanjem / Hot - dip galvanized



Plafonski UD nosač velike nosivosti / Large capacity UD carrier for ceiling

MS

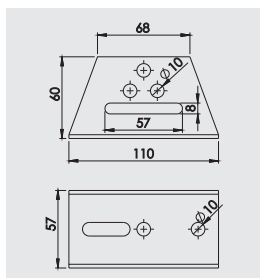

Tip Typ	Debljina Thickness	Nosivost Load	Pakovanje Pack kom piece	Šifra artikla Article
UD U7 PL	3 mm	774 kg	10	PL 30010033
UD U7 TC	3 mm	774 kg	10	TC 30020033

PL Pocinkovani lim / Galvanized sheet

TC Toplo pocinkovano potapanjem / Hot - dip galvanized



U profil velike nosivosti / Large capacity U profile

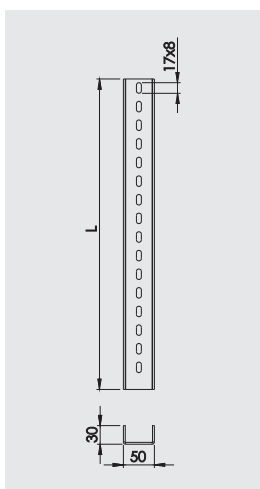

Tip Typ	Dužina L Length L	Debljina Thickness	Pakovanje Pack kom piece	Šifra artikla Article
U 7 50 PL	500 mm	3 mm	10	PL 30010028
U 7 100 PL	1000 mm	3 mm	4	30010029
U 7 150 PL	1500 mm	3 mm	4	30010030
U 7 200 PL	2000 mm	3 mm	4	30010031
U 7 50 TC	500 mm	3 mm	10	TC 30020028
U 7 100 TC	1000 mm	3 mm	4	30020029
U 7 150 TC	1500 mm	3 mm	4	30020030
U 7 200 TC	2000 mm	3 mm	4	30020031

PL Pocinkovani lim / Galvanized sheet

TC Toplo pocinkovano potapanjem / Hot - dip galvanized



Spojnica U stuba velike nosivosti / Coupling for large capacity U pillar

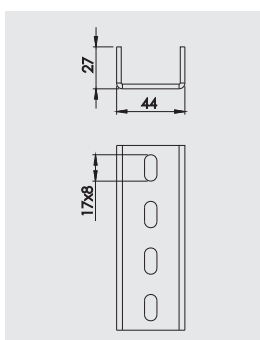

Tip Typ	Dužina L Length L	Debljina Thickness	Pakovanje Pack kom piece	Šifra artikla Article
S U7 PL	200 mm	3 mm	10	PL 30010032
S U7 TC	200 mm	3 mm	10	TC 30020032

PL Pocinkovani lim / Galvanized sheet

TC Toplo pocinkovano potapanjem / Hot - dip galvanized



Nosač za trapezni lim / Carrier for trapezoidal sheet

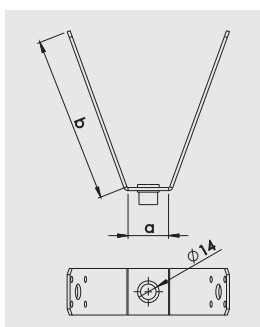

Tip Typ	Debljina Thickness	Centralni otvor Hole	Pakovanje Pack kom piece	Šifra artikla Article
TL 8 PL	2 mm	M8	10	PL 30010034
TL 10 PL	2 mm	M10	10	30010027
TL 8 TC	2 mm	M8	10	TC 30020034
TL 10 TC	2 mm	M10	10	30020027

PL Pocinkovani lim / Galvanized sheet

TC Toplo pocinkovano potapanjem / Hot - dip galvanized



Plafonski G nosač / G carrier for ceilings

MS

Montažni sistemi

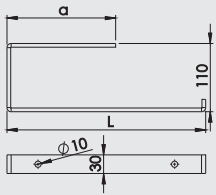

Tip Typ	Dužina L Length L	Otvor Hole	Debljina Thickness	Nosivost Load	Pakovanje Pack kom piece	Šifra artikla Article
	mm	mm	mm	kg		PL
G PNK 100 PL	100	10	6	78	10	30010023
G PNK 160 PL	160	10	6	67	10	30010024
G PNK 200 PL	200	10	6	63	10	30010025
G PNK 300 PL	300	10	6	40	10	30010026
						TC
G PNK 100 TC	100	10	6	78	10	30020023
G PNK 160 TC	160	10	6	67	10	30020024
G PNK 200 TC	200	10	6	63	10	30020025
G PNK 300 TC	300	10	6	40	10	30020026

PL Pocinkovani lim / Galvanized sheet **TC** Toplo pocinkovano potapanjem / Hot - dip galvanized

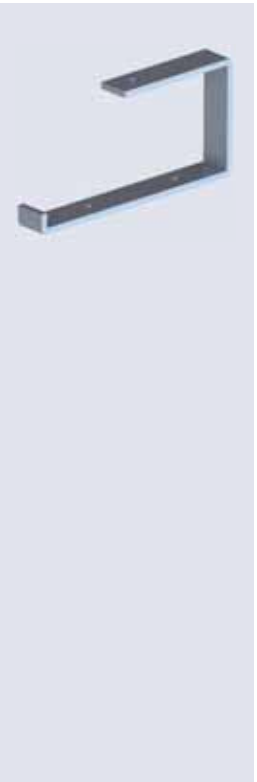
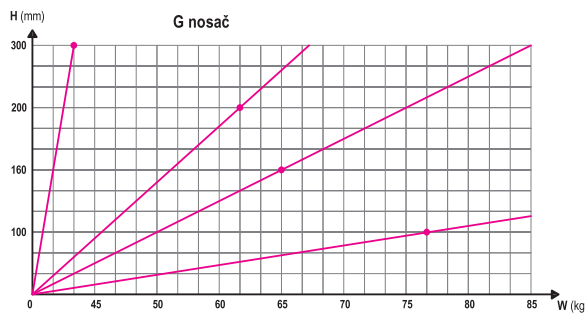

C nosač / C carrier

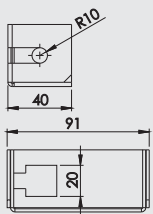

Tip Typ	Debljina Thickness	Pakovanje Pack kom piece	Šifra artikla Article
	mm		PL
CN PL	2	10	30010057
			TC
CN TC	2	10	30020057

PL Pocinkovani lim / Galvanized sheet **TC** Toplo pocinkovano potapanjem / Hot - dip galvanized



Odstojnik / Spacer

MS

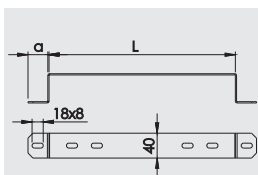

Tip Typ	Dužina L Length L	Pakovanje Pack kom piece	Šifra artikla Article
	mm		PL
OD 10 PL	100	10	30010035
OD 16 PL	160	10	30010036
OD 20 PL	200	10	30010037
OD 30 PL	300	10	30010038
OD 40 PL	400	10	30010039
OD 50 PL	500	10	30010040
OD 60 PL	600	10	30010041
			TC
OD 10 TC	100	10	30020035
OD 16 TC	160	10	30020036
OD 20 TC	200	10	30020037
OD 30 TC	300	10	30020038
OD 40 TC	400	10	30020039
OD 50 TC	500	10	30020040
OD 60 TC	600	10	30020041

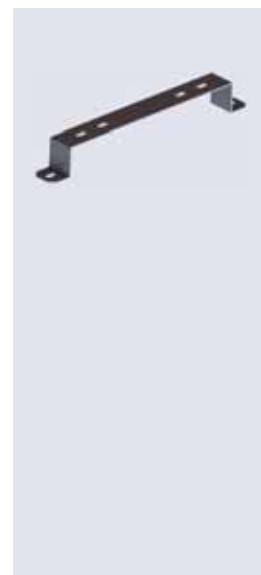

PL Pocinkovani lim / Galvanized sheet TC Toplo pocinkovano potapanjem / Hot - dip galvanized

Središnji nosač / Central carrier

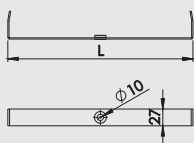

Tip Typ	Dužina L Length L	Debljina Thickness	Centralni otvor Hole	Pakovanje Pack kom piece	Šifra artikla Article
	mm	mm	mm		PL
SN 10 M8 PL	94	3	M8	10	30010042
SN 16 M8 PL	154	3	M8	10	30010043
SN 20 M8 PL	195	3	M8	10	30010044
SN 30 M8 PL	295	3	M8	10	30010045
SN 10 M10 PL	94	3	M10	10	30010078
SN 16 M10 PL	154	3	M10	10	30010079
SN 20 M10 PL	195	3	M10	10	30010080
SN 30 M10 PL	295	3	M10	10	30010081
					TC
SN 10 M8 TC	94	3	M8	10	30020042
SN 16 M8 TC	154	3	M8	10	30020043
SN 20 M8 TC	195	3	M8	10	30020044
SN 30 M8 TC	295	3	M8	10	30020045
SN 10 M10 TC	94	3	M10	10	30020078
SN 16 M10 TC	154	3	M10	10	30020079
SN 20 M10 TC	195	3	M10	10	30020080
SN 30 M10 TC	295	3	M10	10	30020081

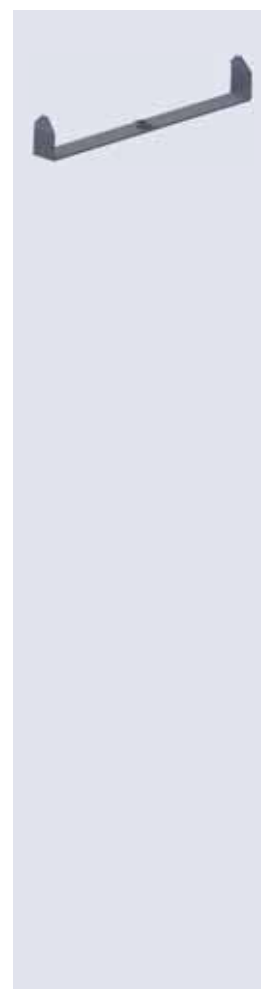

PL Pocinkovani lim / Galvanized sheet TC Toplo pocinkovano potapanjem / Hot - dip galvanized

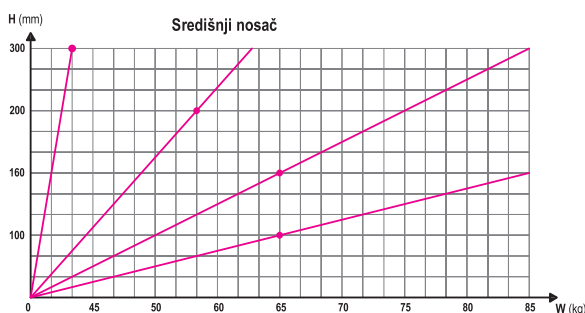

Perforirana šina sa jednom navojnom šipkom / Perforated track with one threaded rod

MS

Montažni sistemi

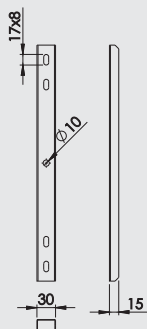

Tip Typ	Dužina L Lenght L	Dimenzije Dimensions	Debljina Thickness	Pakovanje Pack kom piece	Šifra artikla Article
	mm	mm	mm		PL
PS L 05 PL	50	30x15	2	10	30010072
PS L 10 PL	100	30x15	2	10	30010073
PS L 16 PL	160	30x15	2	10	30010074
PS L 20 PL	200	30x15	2	10	30010075
PS L 30 PL	300	30x15	2	10	30010076
					TC
PS L 05 TC	50	30x15	2	10	30020072
PS L 10 TC	100	30x15	2	10	30020073
PS L 16 TC	160	30x15	2	10	30020074
PS L 20 TC	200	30x15	2	10	30020075
PS L 30 TC	300	30x15	2	10	30020076

PL Pocinkovani lim / Galvanized sheet **TC** Toplo pocinkovano potapanjem / Hot - dip galvanized

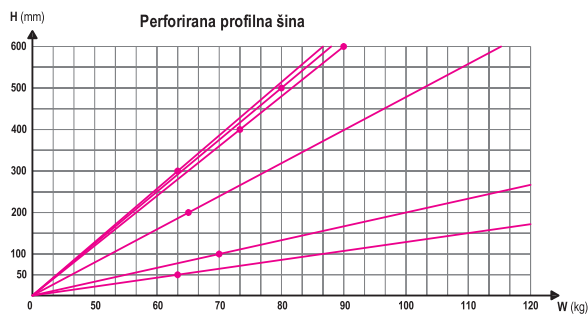

Perforirana šina sa dve navojne šipke / Perforated track with two threaded rods

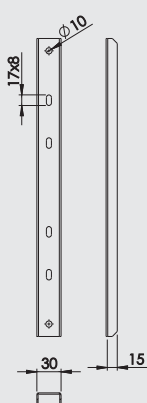

Tip Typ	Dužina L Lenght L	Dimenzije Dimensions	Debljina Thickness	Pakovanje Pack kom piece	Šifra artikla Article
	mm	mm	mm		PL
PS L 2M 15 PL	2000	30x15	1.5	10	30010089
PS L 2M 20 PL	2000	30x15	2	10	30010090
PS L 13 PL	130	30x15	2	10	30010077
PS L 18 PL	180	30x15	2	10	30010047
PS L 24 PL	240	30x15	2	10	30010048
PS L 28 PL	280	30x15	2	10	30010049
PS L 38 PL	380	30x15	2	10	30010050
PS L 48 PL	480	30x15	2	10	30010051
PS L 58 PL	580	30x15	2	10	30010052
PS L 68 PL	680	30x15	2	10	30010053
					TC
PS L 2M 15 TC	2000	30x15	1.5	10	30020089
PS L 2M 20 TC	2000	30x15	2	10	30020090
PS L 13 TC	130	30x15	2	10	30020077
PS L 18 TC	180	30x15	2	10	30020047
PS L 24 TC	240	30x15	2	10	30020048
PS L 28 TC	280	30x15	2	10	30020049
PS L 38 TC	380	30x15	2	10	30020050
PS L 48 TC	480	30x15	2	10	30020051
PS L 58 TC	580	30x15	2	10	30020052
PS L 68 TC	680	30x15	2	10	30020053

PL Pocinkovani lim / Galvanized sheet **TC** Toplo pocinkovano potapanjem / Hot - dip galvanized



Perforirani L profil / Perforated L Profile

MS

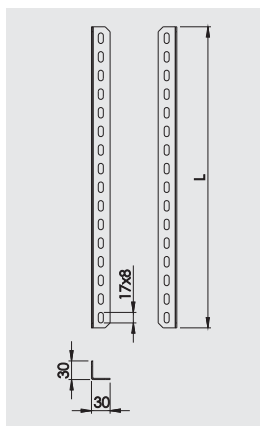

Tip Typ	Dužina L Length L	Dimenzije Dimensions	Debljina Thickness	Pakovanje Pack kom piece	Šifra artikla Article
UP L 2M PL	2000	30x30	2	10	PL 30010055
UP L 2M TC	2000	30x30	2	10	TC 30020055

PL Pocinkovani lim / Galvanized sheet **TC** Toplo pocinkovano potapanjem / Hot-dip galvanized

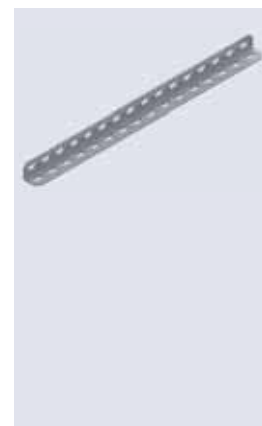

Perforirana traka / Perforated strip

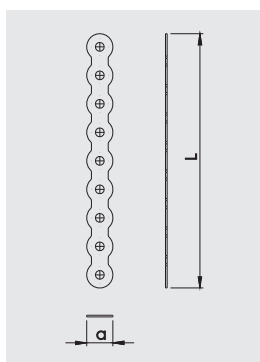

Tip Typ	Dužina L Length L	Širina Width	Otvor Diameter	Pakovanje Pack kom piece	Šifra artikla Article
PTR L 3M PL 6.2	3000	18	6.2	10	PL 30010056
PTR L 3M PL 8.2	3000	18	8.2	10	PL 30010063

PL Pocinkovani lim / Galvanized sheet



Perforirana traka velike nosivosti / Large capacity perforated strip

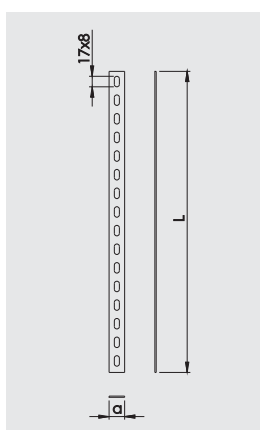

Tip Typ	Dužina L Length L	Širina Width	Debljina Thickness	Pakovanje Pack kom piece	Šifra artikla Article
PTR L 2M PL	2000	25	2	10	PL 30010062

PL Pocinkovani lim / Galvanized sheet



Poklopac U stuba / Cover for U pillar

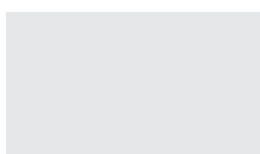

Tip Typ	Dužina L Length L	Širina Width	Debljina Thickness	Pakovanje Pack kom piece	Šifra artikla Article
Poklopac stuba	50	30	10	100	PL 30010100



🔧 Pomoć pri montaži / Assistance in assembly

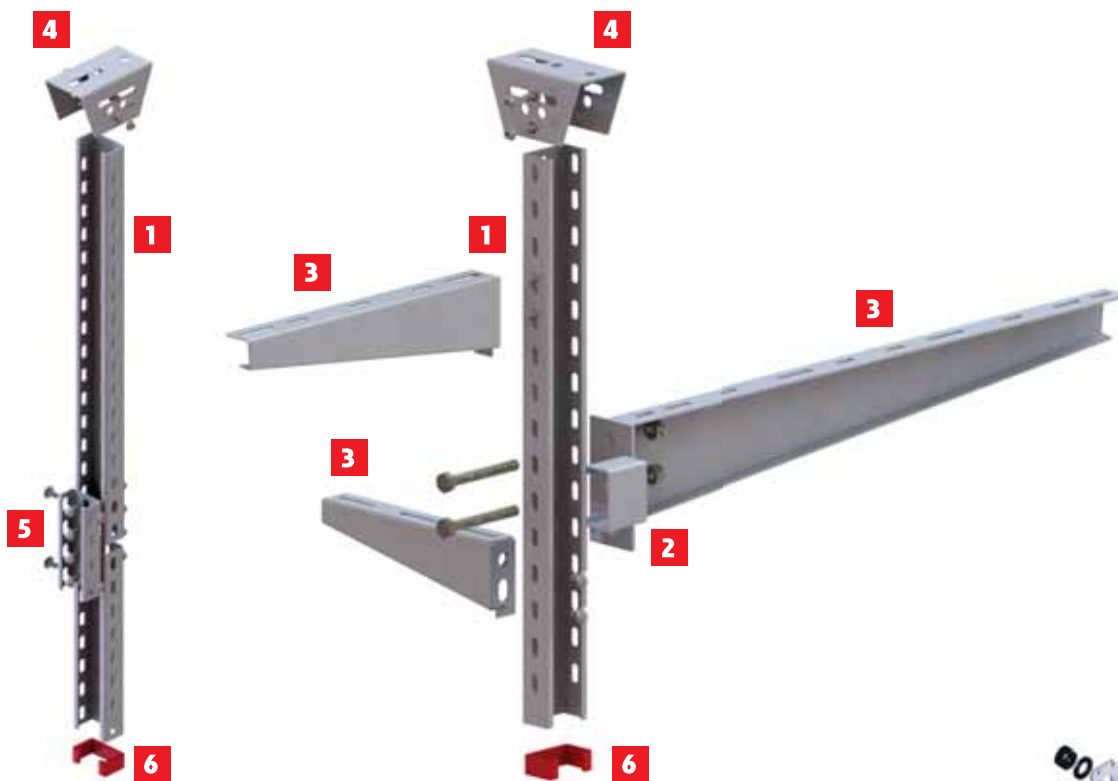

PRINCIP MONTAŽE NA U PROFIL / THE PRINCIPLE OF THE MOUNTING CABLE TRAYS AGAINST THE U PROFILE

- 1** Plafonski U nosač / U carrier for ceilings
- 2** Odstojnik / The spacer
- 3** Zidna konzola nosača / Wall cantilever
- 4** UD nosač za plafon / Ceiling UD carrier for mounting
- 5** Spojnica U profila / U profile coupling
- 6** Poklopac U profila / Cover for U profile

PRINCIP MONTAŽE NA NAVOJNU ŠIPKU / THE PRINCIPLE OF THE MOUNTING CABLE TRAYS AGAINST THE THREADED ROD

- 1** Plafonski C nosač / C carrier for ceilings
- 2** Nosač trapeznog lima / Carrier for trapezoidal sheet
- 3** Navojna šipka / Threaded rod
- 4** Središnji nosač / Central carrier
- 5** G nosač / Ceiling G carrier
- 6** Odstojnik / The spacer

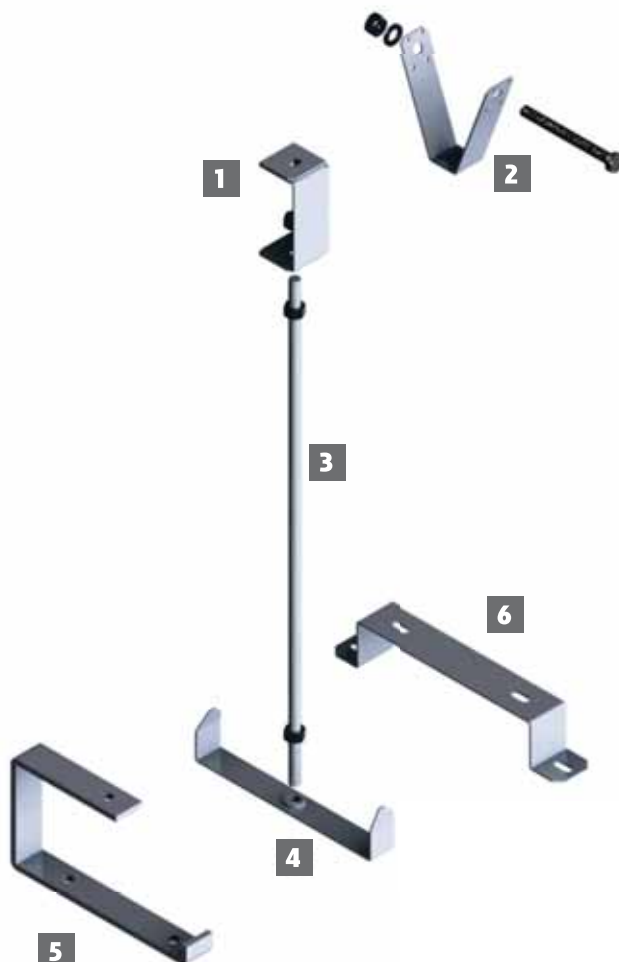

H30

H50

H60

H85

H110

POK

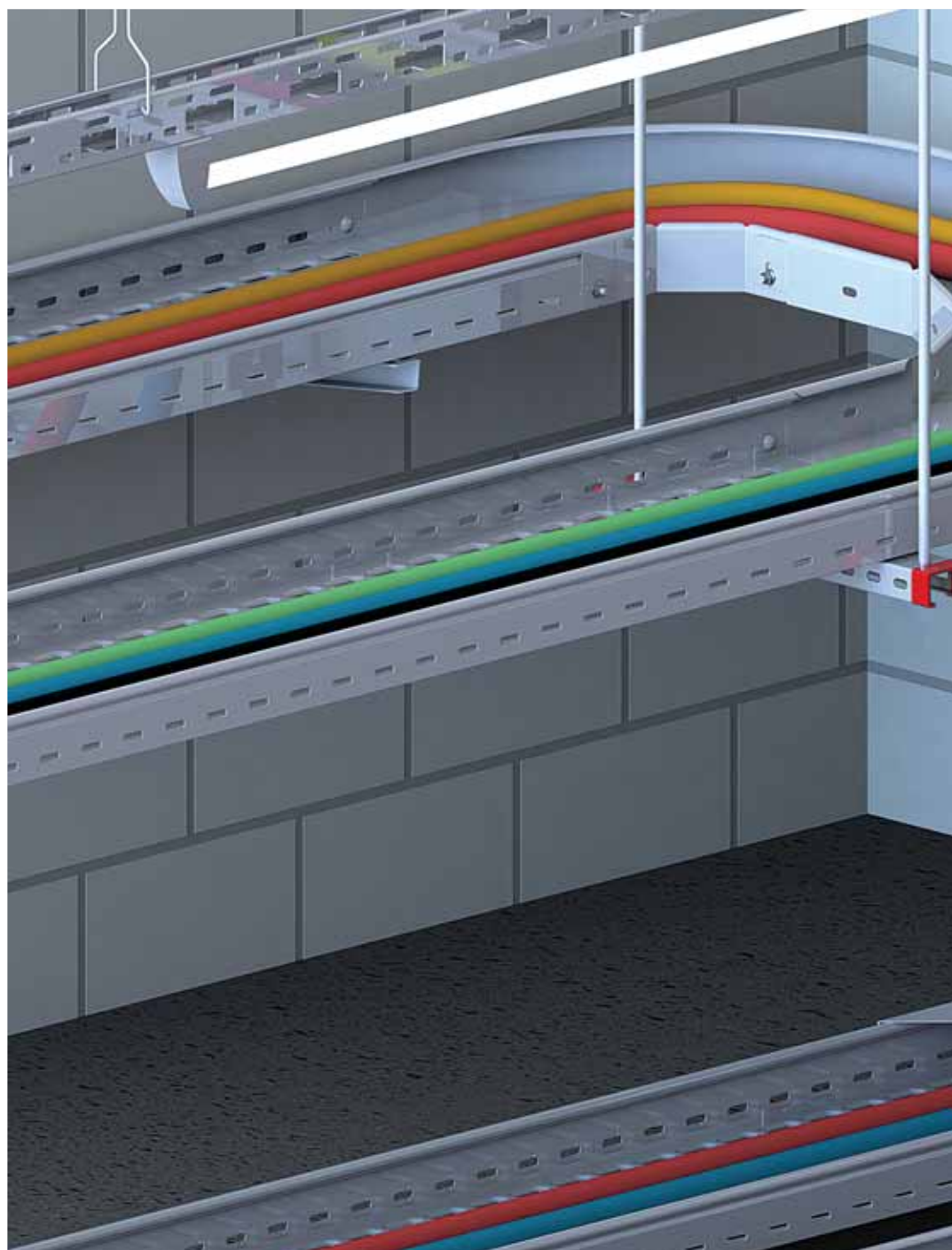

PNK

2

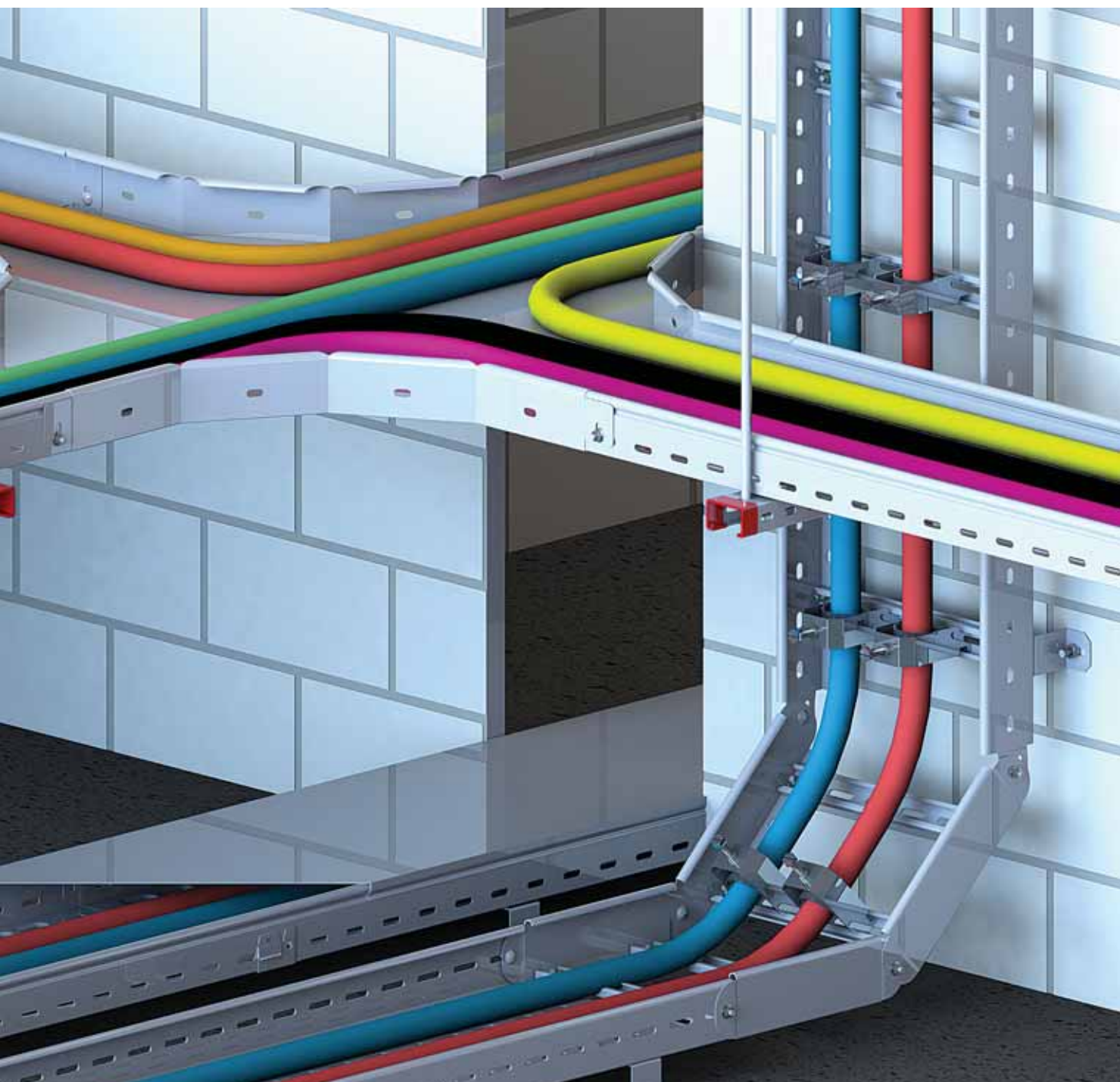

PERFORIRANI NOSAČI KABLOVA

PERFORATED CABLE TRAY SYSTEMS



1

Plafonska montaža regala u više nivoa vrši se pomoću UD nosača, U profila i konzola.

We use UD carrier, U channel and cantilever for mounting cable trays on different levels to the ceiling.



2

Spoj regala podno-rotirajućom spojnicom za premošćavanje visinske razlike.

Joint of the cable trays with floor-rotating coupling for bridging the height difference.



3

Montaža regala za trapezni plafon ostvaruje se pomoću nosača za trapezni lim, navojne šipke i nosača regala.

We use brackets for trapezoidal sheet metal, threaded rod and cable tray for mounting cable trays to the trapezoidal ceiling.



4

Zalamajuća spojnica koristi se za izradu ugaonih krivina na licu mesta, a ugao se formira sečenjem krajeva regala.

Angle connector is used for making angle curves when mounting, and we make an angle by cutting the ends of the cable carriers.



5

Za montažu regala na plafon pomoću dve navojne šipke, koristi se profilna perforirana šina.

We use a profiled perforated rail for mounting cable tray against the ceiling by two threaded rods.



6

Pričvršćivanje nosača kablova za konzolu vrši se torban vijcima PEKOM M6x12.

Attachment of the cable trays to the cantilever is done by PEKOM M6 x 12 torch screw.



7

Montaža regala na odstojnik vrši se pomoću torban vijaka tipa PEKOM M6x12.

We use PEKOM M6 x 12 torch screws for mounting cable tray to the spacer.



8

Keder guma se koristi kao zaštita od oštih ivica prilikom sečenja regala brusilicom na licu mesta.

Kedar rubber is used as a protection against the sharp edges made when cable trays are cut by grinder on the spot.



9

Zglobna spojnica koristi se kod premošćavanja razlike u visinama. Zglobna spojnica se može fiksirati pod određenim uglovima.

Angle connector is used for bridging the difference in heights. Angle connector can be fixed at certain angles.



10

Spoj regala podno-rotirajućom spojnicom za premošćavanje visinske razlike.

Joint of the cable trays with floor-rotating coupling for bridging the height difference.



11

Montaža regala za trapezni plafon ostvaruje se pomoću nosača za trapezni lim, navojne šipke i nosača regala.

We use brackets for trapezoidal sheet metal, threaded rod and cable tray for mounting cable trays against the trapezoidal ceiling.



12

Montaža krivine vrši se na licu mesta. Regali se ubacuju (uvlače) u krivine, a spoj regala i krivina ostvaren je vijcima tipa PEKOM M6x12.

Mounting the bend is done on the spot. Cable trays are pulled into the bands, and the connection is made by PEKOM M6 x 12 torch screws.



13

Pričvršćivanje nosača kablova za konzolu vrši se torban vijcima PEKOM M6 x 12 i nazubljenim maticama M6.

Attachment of the cable trays to the cantilever is done by the PEKOM torch bolt, type M6 x 12, without additional couplings.



14

Montaža krivine 90° i regala nosača kablova ostvaruje se putem vijaka tipa PEKOM M6 x 12, bez dodatnih spojnica.

Mounting of the 90° curve and the cable tray is done by the PEKOM M6 x 12 type screws.

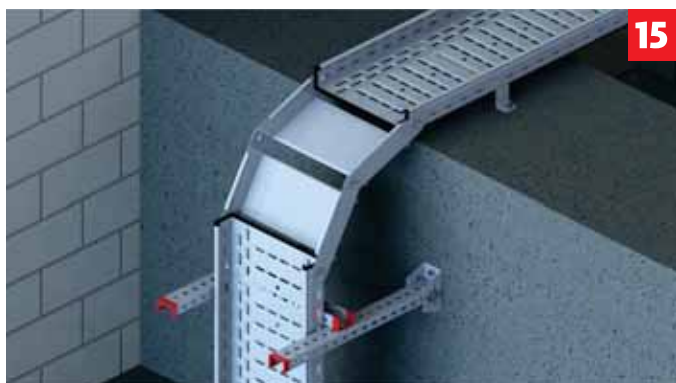

15

Zglobna krivina za premošćavanje razlike u visinama.

Angle curve for bridging the difference in heights.



16

Montaža nosača kablova na jednu navojnu šipku pomoću središnjeg nosača.

Mounting cable trays on a threaded rod by a midway carrier.

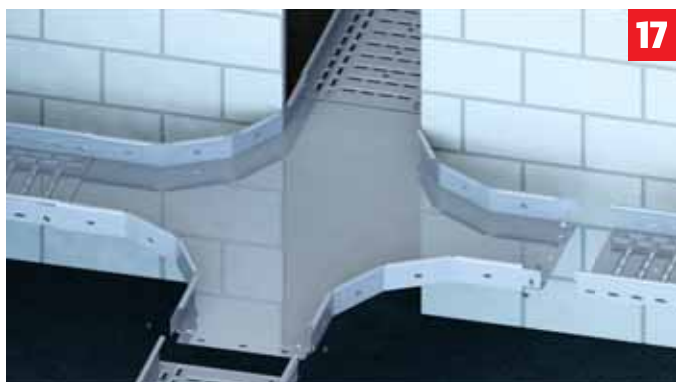

17

Montaža + račve i regala nosača kablova ostvarena je direktnom vezom pomoću torban vijaka tipa PEKOM M6 x 12 bez dodatnih spojnica.

Installation of the cross-section twitch and cable tray carrier was achieved by direct connection with the PEKOM torch bolt, type M6 x 12, without additional couplings.



18

PNK poklopac montira se bez dodatnih vijaka i stezaljki jednostavnim klik sistemom. Vrlo je jednostavna i brza demontaža poklopca.

Lid for perforated cable trays is mounted without additional screws and clamps by a simple CLICK system. Disassembly of the lid is very simple and fast.



19

Montaža T račve i regala nosača kablova ostvarena je pomoću torban vijaka tipa PEKOM M6 x 12, bez dodatnih spojnica.

Mounting of the T twitch and the cable tray is done by using the PEKOM M6 x 12 torch screw.



20

Montažom vertikalne ugradne račve postiže se efekat odlivnog levka po visini.

By mounting vertical embedded twitch we have the effect of leakage funnel.

Perforirani nosači kablova



21

Princip spoja dva PNK regala sa klik sistemom bez dodatnih vijaka.

The principle of connecting two PNK cable trays by click system, without additional bolts.



22

Jedan klik... i gotovo...

Just a click... and done...



23

Bočno usecanje regala i montaža ugradne račve vrši se na licu mesta. Ugradna račva na usečeni deo regala pričvršćuje se torban vijcima tipa PEKOM M6 x 12 bez dodatnih spojnica.

Side cutting of the cable trays and mounting of the built-in twitch is done on the spot. Built-in twitch is attached to the cut side of the cable tray by the PEKOM torch bolt, type M6 x 12, without additional couplings.



24

Bočno usecanje regala i montaža ugradne račve vrši se na licu mesta. Ugradna račva na usečeni deo regala pričvršćuje se torban vijcima tipa PEKOM M6 x 12 bez dodatnih spojnica.

Side cutting of the cable trays and mounting of the built-in twitch is done on the spot. Built-in twitch is attached to the cut side of the cable tray by the PEKOM torch bolt, type M6 x 12, without additional couplings.

Connecting PNK Cable Tray

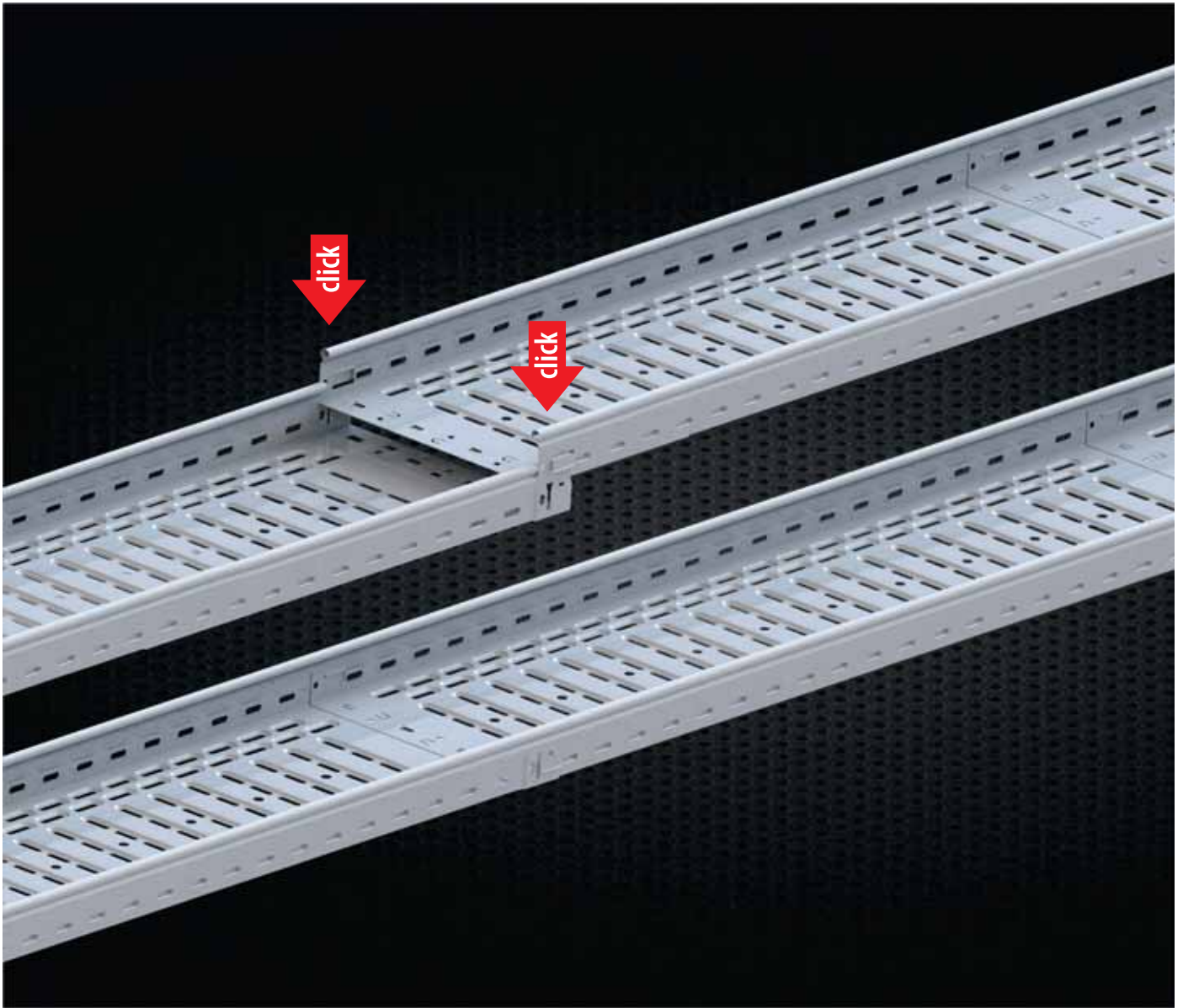

Nosač kablova PNK / PNK cable trays

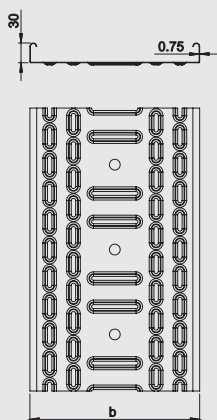
H30

Tip Typ	Širina Width	Visina Height	Debljina Thickness	Dužina Length	Korisni presek Useful section	Dozvoljeno opterećenje Allowed load			Šifra artikla Article
						1.5 m	2.0 m	2.5 m	
PNK 3 5 200 PL	50	30	0.75	2000	13	115	60	40	10010001
PNK 3 10 200 PL	100	30	0.75	2000	35	112	58	38	10010003
PNK 3 16 200 PL	160	30	0.75	2000	45	111	57	36	10010008
PNK 3 20 200 PL	200	30	0.75	2000	70	110	55	32	10010013
PNK 3 30 200 PL	300	30	0.75	2000	105	101	58	39	10010018
									PL
PNK 3 5 300 PL	50	30	0.75	3000	13	115	60	40	10010016
PNK 3 10 300 PL	100	30	0.75	3000	35	112	58	38	10010017
PNK 3 16 300 PL	160	30	0.75	3000	45	111	57	36	10010021
PNK 3 20 300 PL	200	30	0.75	3000	70	110	55	32	10010022
PNK 3 30 300 PL	300	30	0.75	3000	105	101	58	39	10010026

PL Pocinkovani lim / Galvanized sheet

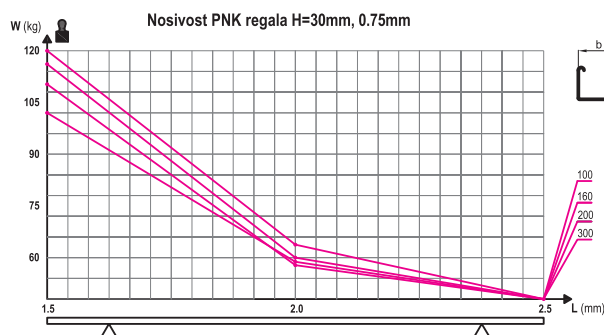

Pregrada / Divider

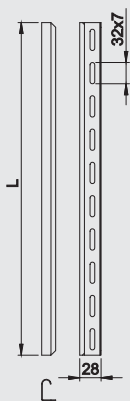

Tip Typ	Visina Height	Dužina Length	Pakovanje Pack kom piece	Šifra artikla Article
P PNK 30 2M PL	30	2000	10	10030001
P PNK 30 3M PL	30	3000	10	10030002

PL Pocinkovani lim / Galvanized sheet

Bočna spojnica / Straight connector

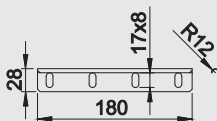

Tip Typ	Visina Height	Pakovanje Pack kom piece	Šifra artikla Article
S PNK 30 PL	30	50	10030003

PL Pocinkovani lim / Galvanized sheet

Lomljiva spojnica / Angle connector

H30

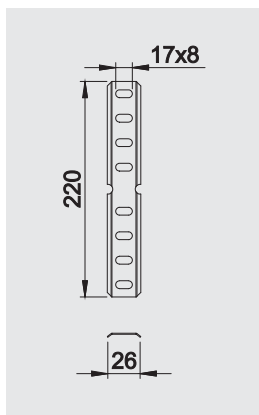

Tip Typ	Visina Height	Pakovanje Pack kom piece	Šifra artikla Article
LS PNK 30 PL	mm 30	50	PL 10030004

PL Pocinkovani lim / Galvanized sheet



Zglobna spojnica / Adjustable connector

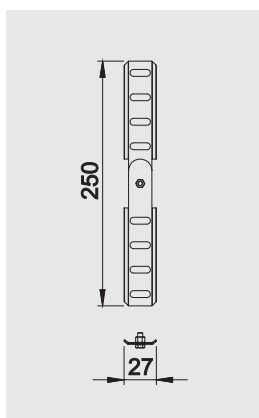

Tip Typ	Visina Height	Pakovanje Pack kom piece	Šifra artikla Article
ZS PNK 30 PL	mm 30	50	PL 10030005

PL Pocinkovani lim / Galvanized sheet



Ugradna račva / Add-one tee

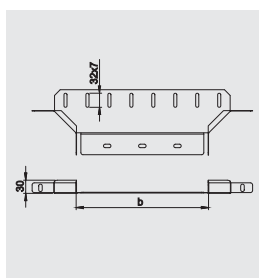

Tip Typ	Širina Width	Visina Height	Debljina Thickness	Šifra artikla Article
UR PNK 3 5 PL	mm 50	mm 30	mm 1	PL 10030006
UR PNK 3 10 PL	100	30	1	10030007
UR PNK 3 16 PL	160	30	1	10030008
UR PNK 3 20 PL	200	30	1	10030009
UR PNK 3 30 PL	300	30	1	10030010

PL Pocinkovani lim / Galvanized sheet



Krivina 45° / Bend 45°

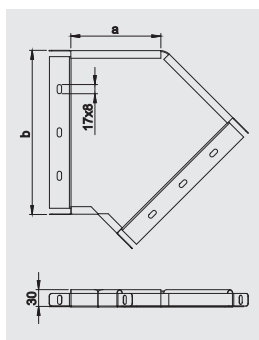

Tip Typ	Širina Width	Visina Height	Debljina Thickness	Šifra artikla Article
K45 PNK 3 5 PL	mm 50	mm 30	mm 1	PL 10030011
K45 PNK 3 10 PL	100	30	1	10030012
K45 PNK 3 16 PL	160	30	1	10030013
K45 PNK 3 20 PL	200	30	1	10030014
K45 PNK 3 30 PL	300	30	1	10030015

PL Pocinkovani lim / Galvanized sheet

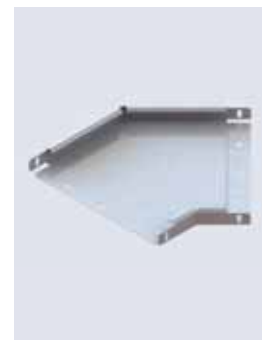

Krivina 90° / Bend 90°

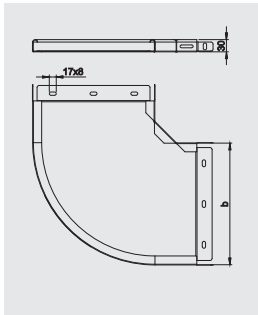
H30

Tip Typ	Širina Width	Visina Height	Debljina Thickness	Šifra artikla Article
	mm	mm	mm	PL
L PNK 3 5 PL	50	30	1	10030016
L PNK 3 10 PL	100	30	1	10030017
L PNK 3 16 PL	160	30	1	10030018
L PNK 3 20 PL	200	30	1	10030019
L PNK 3 30 PL	300	30	1	10030020

PL Pocinkovani lim / Galvanized sheet



Perforirani nosači kablova

Ugaona spojnica / Corner connector

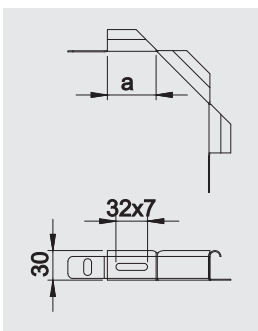

Tip Typ	Širina Width	Visina Height	Debljina Thickness	Šifra artikla Article
	mm	mm	mm	PL
US PNK 3 5 PL	50	30	1	10030021
US PNK 3 10 PL	100	30	1	10030022
US PNK 3 16 PL	160	30	1	10030023
US PNK 3 20 PL	200	30	1	10030024
US PNK 3 30 PL	300	30	1	10030025

PL Pocinkovani lim / Galvanized sheet



T račva / T Module

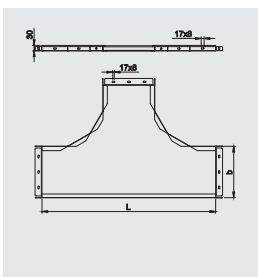

Tip Typ	Širina Width	Visina Height	Debljina Thickness	Šifra artikla Article
	mm	mm	mm	PL
T PNK 3 5 PL	50	30	1	10030026
T PNK 3 10 PL	100	30	1	10030027
T PNK 3 16 PL	160	30	1	10030028
T PNK 3 20 PL	200	30	1	10030029
T PNK 3 30 PL	300	30	1	10030030

PL Pocinkovani lim / Galvanized sheet



Račva plus / + Connection module

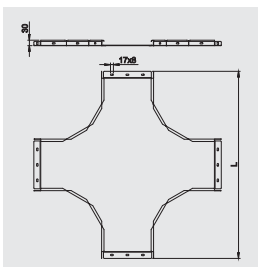

Tip Typ	Širina Width	Visina Height	Debljina Thickness	Šifra artikla Article
	mm	mm	mm	PL
X PNK 3 5 PL	50	30	1	10030031
X PNK 3 10 PL	100	30	1	10030032
X PNK 3 16 PL	160	30	1	10030033
X PNK 3 20 PL	200	30	1	10030034
X PNK 3 30 PL	300	30	1	10030035

PL Pocinkovani lim / Galvanized sheet

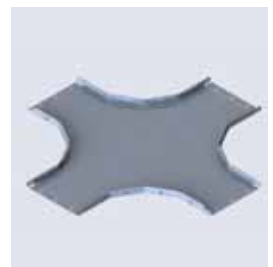

Elementi zglobno vertikalne krivine / Adjustable vertical bend element

H30

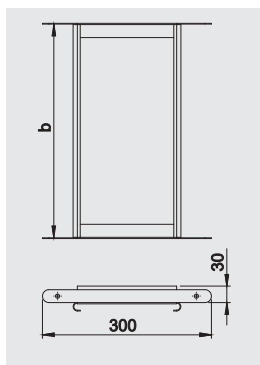

Tip Typ	Širina Width	Visina Height	Debljina Thickness	Šifra artikla Article
	mm	mm	mm	PL
EZK PNK 3 10 PL	100	30	1	10030036
EZK PNK 3 16 PL	160	30	1	10030037
EZK PNK 3 20 PL	200	30	1	10030038
EZK PNK 3 30 PL	300	30	1	10030039
EZK PNK 3 40 PL	400	30	1	10030040

PL Pocinkovani lim / Galvanized sheet



Zglobno vertikalna krivina / Adjustable vertical bend

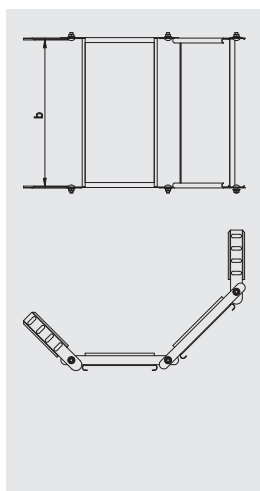

Tip Typ	Širina Width	Visina Height	Debljina Thickness	Šifra artikla Article
	mm	mm	mm	PL
ZK PNK 3 10 PL	100	30	1	10030041
ZK PNK 3 16 PL	160	30	1	10030042
ZK PNK 3 20 PL	200	30	1	10030043
ZK PNK 3 30 PL	300	30	1	10030044
ZK PNK 3 40 PL	400	30	1	10030045

PL Pocinkovani lim / Galvanized sheet

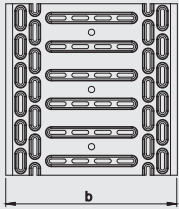

Nosáč kablova PNK / PNK cable trays

H50

Tip Typ	Širina Width	Visina Height	Debljina Thickness	Dužina Length	Korisni presek Useful section	Dozvoljeno opterećenje Allowed load			Šifra artikla Article
						1.5 m	2.0 m	2.5 m	
PNK 5 5 300 PL	50	50	0.75	3000	23	123	78	44	10010002
PNK 5 10 300 PL	100	50	0.75	3000	48	121	80	50	10010004
PNK 5 16 300 PL	160	50	0.75	3000	78	128	81	48	10010009
PNK 5 20 300 PL	200	50	0.75	3000	98	132	77	47	10010014
PNK 5 30 300 PL	300	50	0.75	3000	148	112	78	42	10010019
PNK 5 40 300 PL	400	50	1	3000	198	153	123	69	10010023
PNK 5 50 300 PL	500	50	1	3000	248	156	125	62	10010027
PNK 5 60 300 PL	600	50	1	3000	298	158	128	62	10010030
PL									
PNK 5 5 200 PL	50	50	0.75	2000	23	123	78	44	10010275
PNK 5 10 200 PL	100	50	0.75	2000	48	121	80	50	10010276
PNK 5 16 200 PL	160	50	0.75	2000	78	128	81	48	10010277
PNK 5 20 200 PL	200	50	0.75	2000	98	132	77	47	10010278
PNK 5 30 200 PL	300	50	0.75	2000	148	112	78	42	10012079
PNK 5 40 200 PL	400	50	1	2000	198	153	123	69	10012080
PNK 5 50 200 PL	500	50	1	2000	248	156	125	62	10012081
PNK 5 60 200 PL	600	50	1	2000	298	158	128	62	10012082

PL Pocinkovani lim / Galvanized sheet

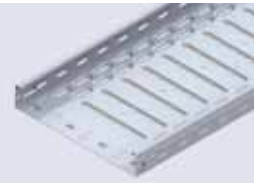
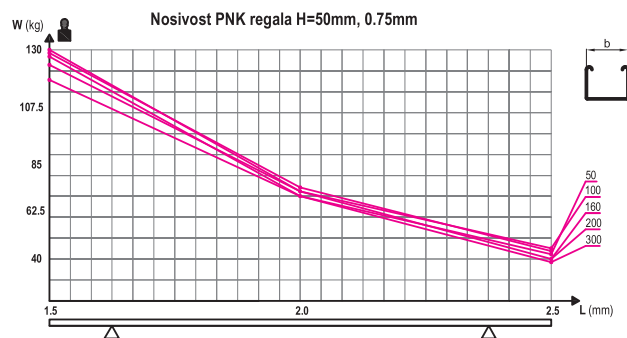

Nosač kablova SNK / SNK cable trays

H50

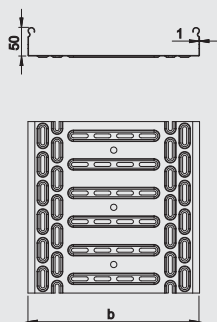

Tip Typ	Širina Width	Visina Height	Debljina Thickness	Dužina Length	Korisni presek Useful section	Dozvoljeno opterećenje Allowed load			Šifra artikla Article
						1.5 m	2.0 m	2.5 m	
SNK 5 5 300 PL	50	50	1	3000	23	152	102	60	10070000
SNK 5 10 300 PL	100	50	1	3000	48	150	98	55	10070001
SNK 5 16 300 PL	160	50	1	3000	78	148	100	58	10070002
SNK 5 20 300 PL	200	50	1	3000	98	142	99	52	10070003
SNK 5 30 300 PL	300	50	1	3000	148	138	88	48	10070004
SNK 5 40 300 PL	400	50	1	3000	198	153	123	69	10070005
SNK 5 50 300 PL	500	50	1	3000	248	156	125	62	10070006
SNK 5 60 300 PL	600	50	1	3000	298	158	128	62	10070007
									PL
SNK 5 5 200 PL	50	50	1	2000	23	152	102	60	10070008
SNK 5 10 200 PL	100	50	1	2000	48	150	98	55	10070009
SNK 5 16 200 PL	160	50	1	2000	78	148	100	58	10070010
SNK 5 20 200 PL	200	50	1	2000	98	142	99	52	10070011
SNK 5 30 200 PL	300	50	1	2000	148	138	88	48	10070012
SNK 5 40 200 PL	400	50	1	2000	198	125	80	47	10070013
SNK 5 50 200 PL	500	50	1	2000	248	122	75	45	10070014
SNK 5 60 200 PL	600	50	1	2000	298	121	74	41	10070015
									TC
SNK 5 5 300 TC	50	50	1	3000	23	152	102	60	10020000
SNK 5 10 300 TC	100	50	1	3000	48	150	98	55	10020001
SNK 5 16 300 TC	160	50	1	3000	78	148	100	58	10020002
SNK 5 20 300 TC	200	50	1	3000	98	142	99	52	10020003
SNK 5 30 300 TC	300	50	1	3000	148	138	88	48	10020004
SNK 5 40 300 TC	400	50	1	3000	198	125	80	47	10020005

PL Pocinkovani lim / Galvanized sheet TC Toplo pocinkovano potapanjem / Hot - dip galvanized

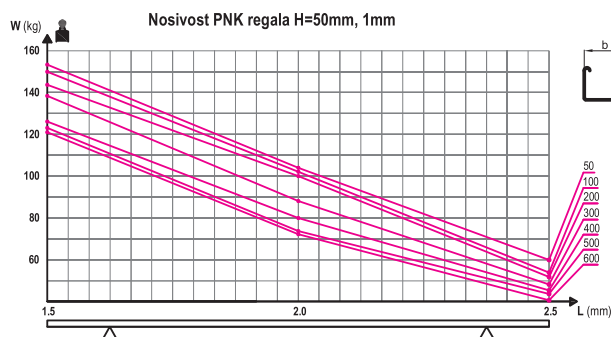

Nosač kablova VNK / VNK cable trays

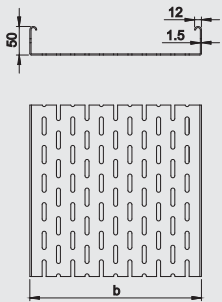
H50

Tip Typ	Širina Width	Visina Height	Debljina Thickness	Dužina Length	Korisni presek Useful section	Dozvoljeno opterećenje Allowed load			Šifra artikla Article
						1.5 m	2.0 m	2.5 m	
VNK 5 5 300 PL	50	50	1.5	3000	23	253	201	120	10080000
VNK 5 10 300 PL	100	50	1.5	3000	48	251	198	118	10080001
VNK 5 16 300 PL	160	50	1.5	3000	78	250	199	119	10080002
VNK 5 20 300 PL	200	50	1.5	3000	98	249	196	105	10080003
VNK 5 30 300 PL	300	50	1.5	3000	148	248	195	100	10080004
VNK 5 40 300 PL	400	50	1.5	3000	198	240	180	95	10080005
VNK 5 50 300 PL	500	50	1.5	3000	198	236	182	92	10080006
VNK 5 60 300 PL	600	50	1.5	3000	198	230	178	86	10080007
TC									
VNK 5 5 300 TC	50	50	1.5	3000	23	253	201	120	10020006
VNK 5 10 300 TC	100	50	1.5	3000	48	251	198	118	10020007
VNK 5 16 300 TC	160	50	1.5	3000	78	250	199	119	10020008
VNK 5 20 300 TC	200	50	1.5	3000	98	249	196	105	10020009
VNK 5 30 300 TC	300	50	1.5	3000	148	248	195	100	10020010
VNK 5 40 300 TC	400	50	1.5	3000	198	240	180	95	10020011
VNK 5 50 300 TC	500	50	1.5	3000	198	236	182	92	10020012
VNK 5 60 300 TC	600	50	1.5	3000	198	230	178	86	10020013

PL Pocinkovani lim / Galvanized sheet
 TC Toplo pocinkovano potapanjem / Hot - dip galvanized

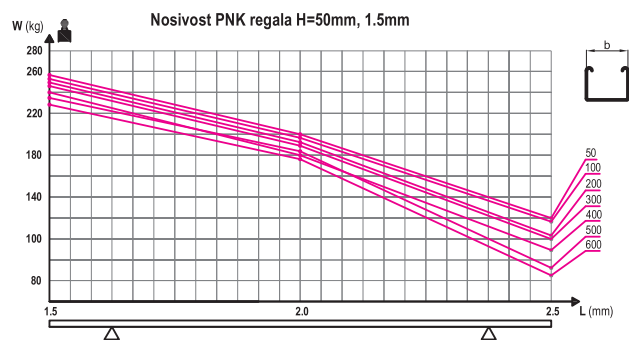

Nosač kablova PNKP / PNKP cable trays

H50

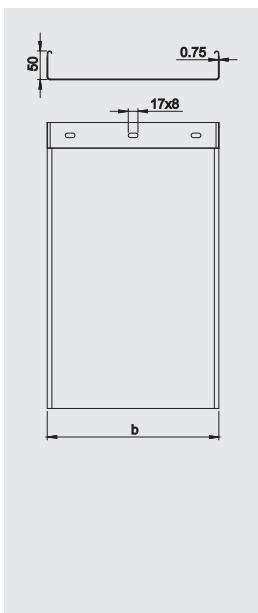

Tip Typ	Širina Width	Visina Height	Debljina Thickness	Dužina Length	Korisni presek Useful section	Dozvoljeno opterećenje Allowed load			Šifra artikla Article
						1.5 m	2.0 m	2.5 m	
PNKP 5 5 300 PL	50	50	0.75	3000	23	112	80	52	10040001
PNKP 5 10 300 PL	100	50	0.75	3000	48	110	78	46	10040002
PNKP 5 20 300 PL	200	50	0.75	3000	98	102	75	48	10040003
PNKP 5 30 300 PL	300	50	0.75	3000	148	100	74	44	10040004

PL Pocinkovani lim / Galvanized sheet

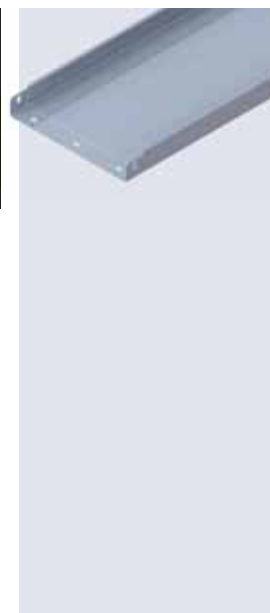
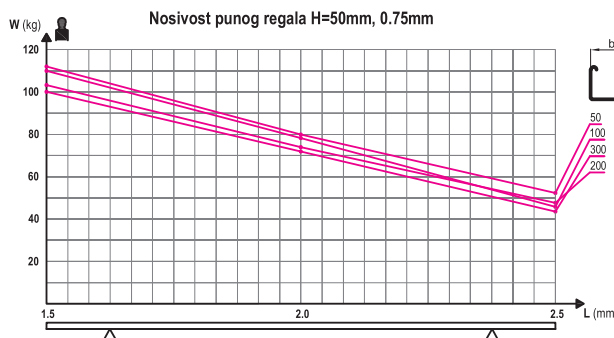

Nosač kablova SNKP / SNKP cable trays

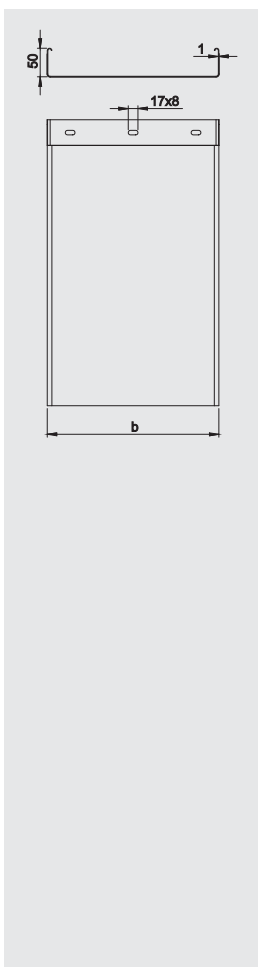

Tip Typ	Širina Width	Visina Height	Debljina Thickness	Dužina Length	Korisni presek Useful section	Dozvoljeno opterećenje Allowed load			Šifra artikla Article
						1.5 m	2.0 m	2.5 m	
SNKP 5 5 300 PL	50	50	1	3000	23	156	104	56	10040005
SNKP 5 10 300 PL	100	50	1	3000	48	152	101	55	10040006
SNKP 5 16 300 PL	160	50	1	3000	78	150	99	50	10040007
SNKP 5 20 300 PL	200	50	1	3000	98	146	98	47	10040008
SNKP 5 30 300 PL	300	50	1	3000	148	144	97	45	10040009
SNKP 5 40 300 PL	400	50	1	3000	198	138	89	42	10040010
SNKP 5 50 300 PL	500	50	1	3000	248	136	87	38	10040011
SNKP 5 60 300 PL	600	50	1	3000	298	132	81	36	10040012
									TC
SNKP 5 5 300 TC	50	50	1	3000	23	156	104	56	10020014
SNKP 5 10 300 TC	100	50	1	3000	48	152	101	55	10020015
SNKP 5 16 300 TC	160	50	1	3000	78	150	99	50	10020016
SNKP 5 20 300 TC	200	50	1	3000	98	146	98	47	10020017
SNKP 5 30 300 TC	300	50	1	3000	148	144	97	45	10020018
SNKP 5 40 300 TC	400	50	1	3000	198	138	89	42	10020019
SNKP 5 50 300 TC	500	50	1	3000	248	136	87	38	10020020
SNKP 5 60 300 TC	600	50	1	3000	298	132	81	36	10020021

PL Pocinkovani lim / Galvanized sheet

TC Toplo pocinkovano potapanjem / Hot - dip galvanized

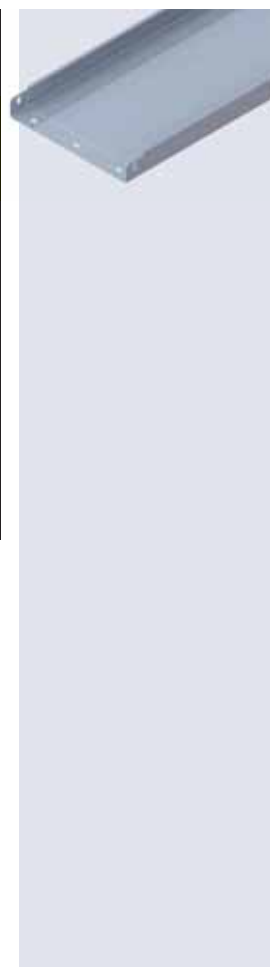
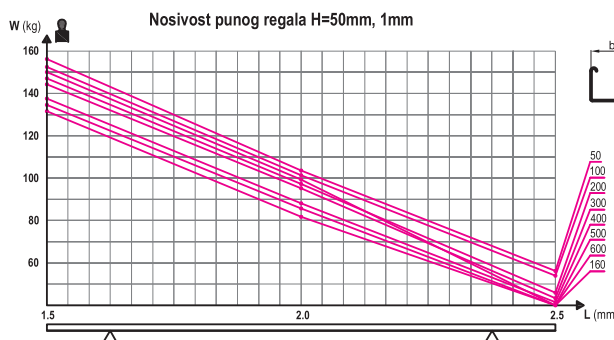

Pregrada / Divider

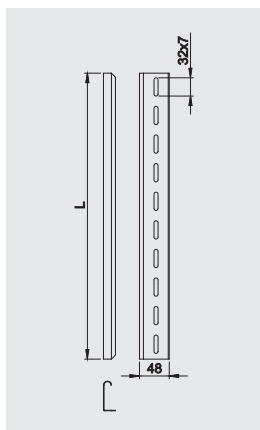
H50

Tip Typ	Visina Height	Duzina Length	Pakovanje Pack kom piece	Šifra artikla Article
P PNK 50 PL	50	3000	10	PL 10030046
P PNK 50 TC	50	3000	10	TC 10020022

PL Pocinkovani lim / Galvanized sheet
 TC Toplo pocinkovano potapanjem / Hot - dip galvanized

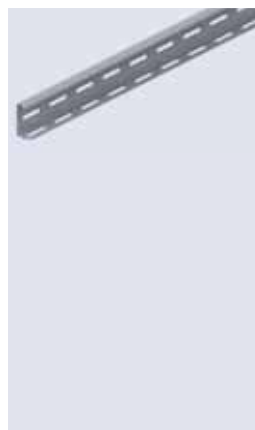

Perforirani nosači kablova

Bočna spojnica / Straight connector

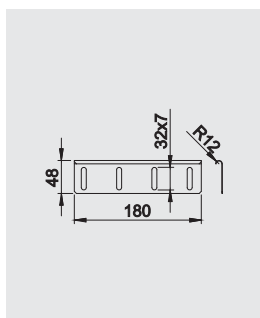

Tip Typ	Visina Height	Pakovanje Pack kom piece	Šifra artikla Article
S PNK 50 PL	50	50	PL 10030047
S PNK 50 TC	50	50	TC 10020023

PL Pocinkovani lim / Galvanized sheet
 TC Toplo pocinkovano potapanjem / Hot - dip galvanized



Lomljiva spojnica / Angle connector

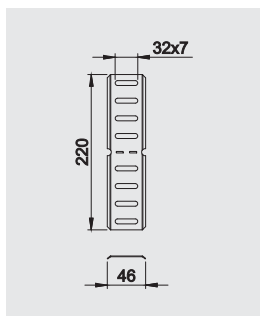

Tip Typ	Visina Height	Pakovanje Pack kom piece	Šifra artikla Article
LS PNK 50 PL	50	50	PL 10030048
LS PNK 50 TC	50	50	TC 10020024

PL Pocinkovani lim / Galvanized sheet
 TC Toplo pocinkovano potapanjem / Hot - dip galvanized



Zglobna spojnica / Adjustable connector

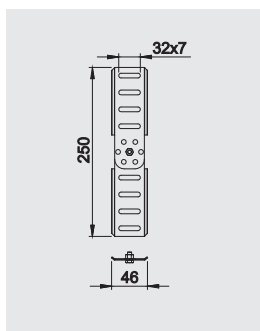

Tip Typ	Visina Height	Pakovanje Pack kom piece	Šifra artikla Article
ZS PNK 50 PL	50	50	PL 10030049
ZS PNK 50 TC	50	50	TC 10020025

PL Pocinkovani lim / Galvanized sheet
 TC Toplo pocinkovano potapanjem / Hot - dip galvanized



Ugradna račva / Add-one tee

H50

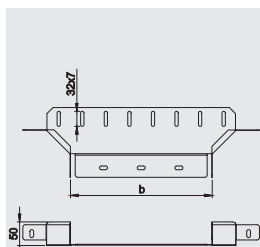

Tip Typ	Širina Width	Visina Height	Debljina Thickness	Šifra artikla Article
	mm	mm	mm	
UR PNK 5 5 PL	50	50	1	10030050
UR PNK 5 10 PL	100	50	1	10030051
UR PNK 5 16 PL	160	50	1	10030052
UR PNK 5 20 PL	200	50	1	10030053
UR PNK 5 30 PL	300	50	1	10030054
UR PNK 5 40 PL	400	50	1	10030055
UR PNK 5 50 PL	500	50	1	10030056
UR PNK 5 60 PL	600	50	1	10030057
				TC
UR PNK 5 5 TC	50	50	1	10020026
UR PNK 5 10 TC	100	50	1	10020027
UR PNK 5 16 TC	160	50	1	10020028
UR PNK 5 20 TC	200	50	1	10020029
UR PNK 5 30 TC	300	50	1	10020030
UR PNK 5 40 TC	400	50	1	10020031
UR PNK 5 50 TC	500	50	1	10020032
UR PNK 5 60 TC	600	50	1	10020033

PL Pocinkovani lim / Galvanized sheet

TC Toplo pocinkovano potapanjem / Hot - dip galvanized



Krivina 45° / Bend 45°

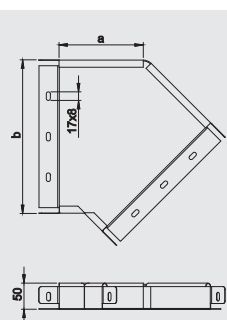

Tip Typ	Širina Width	Visina Height	Debljina Thickness	Šifra artikla Article
	mm	mm	mm	
K45 PNK 5 5 PL	50	50	1	10030058
K45 PNK 5 10 PL	100	50	1	10030059
K45 PNK 5 16 PL	160	50	1	10030060
K45 PNK 5 20 PL	200	50	1	10030061
K45 PNK 5 30 PL	300	50	1	10030062
K45 PNK 5 40 PL	400	50	1	10030063
K45 PNK 5 50 PL	500	50	1	10030064
K45 PNK 5 60 PL	600	50	1	10030065
				TC
K45 PNK 5 5 TC	50	50	1	10020034
K45 PNK 5 10 TC	100	50	1	10020035
K45 PNK 5 16 TC	160	50	1	10020036
K45 PNK 5 20 TC	200	50	1	10020037
K45 PNK 5 30 TC	300	50	1	10020038
K45 PNK 5 40 TC	400	50	1	10020039
K45 PNK 5 50 TC	500	50	1	10020040
K45 PNK 5 60 TC	600	50	1	10020041

PL Pocinkovani lim / Galvanized sheet

TC Toplo pocinkovano potapanjem / Hot - dip galvanized

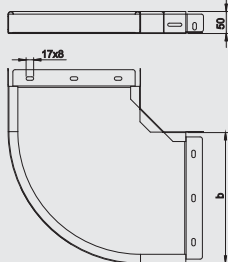

Krivina 90° / Bend 90°

H50

Tip Typ	Širina Width	Visina Height	Debljina Thickness	Šifra artikla Article
	mm	mm	mm	
				PL
L PNK 5 5 PL	50	50	1	10030066
L PNK 5 10 PL	100	50	1	10030067
L PNK 5 16 PL	160	50	1	10030068
L PNK 5 20 PL	200	50	1	10030069
L PNK 5 30 PL	300	50	1	10030070
L PNK 5 40 PL	400	50	1	10030071
L PNK 5 50 PL	500	50	1	10030072
L PNK 5 60 PL	600	50	1	10030073
				TC
L PNK 5 5 TC	50	50	1	10020042
L PNK 5 10 TC	100	50	1	10020043
L PNK 5 16 TC	160	50	1	10020044
L PNK 5 20 TC	200	50	1	10020045
L PNK 5 30 TC	300	50	1	10020046
L PNK 5 40 TC	400	50	1	10020047
L PNK 5 50 TC	500	50	1	10020048
L PNK 5 60 TC	600	50	1	10020049

PL Pocinkovani lim / Galvanized sheet

TC Toplo pocinkovano potapanjem / Hot - dip galvanized



Perforirani nosači kablova

Ugaona spojnica / Corner connector

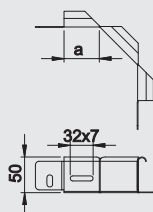

Tip Typ	Širina Width	Visina Height	Debljina Thickness	Šifra artikla Article
	mm	mm	mm	
				PL
US PNK 5 5 PL	50	50	1	10030074
US PNK 5 10 PL	100	50	1	10030075
US PNK 5 16 PL	160	50	1	10030076
US PNK 5 20 PL	200	50	1	10030077
US PNK 5 30 PL	300	50	1	10030078
US PNK 5 40 PL	400	50	1	10030079
US PNK 5 50 PL	500	50	1	10030080
US PNK 5 60 PL	600	50	1	10030081
				TC
US PNK 5 5 TC	50	50	1	10020050
US PNK 5 10 TC	100	50	1	10020051
US PNK 5 16 TC	160	50	1	10020052
US PNK 5 20 TC	200	50	1	10020053
US PNK 5 30 TC	300	50	1	10020054
US PNK 5 40 TC	400	50	1	10020055
US PNK 5 50 TC	500	50	1	10020056
US PNK 5 60 TC	600	50	1	10020057

PL Pocinkovani lim / Galvanized sheet

TC Toplo pocinkovano potapanjem / Hot - dip galvanized



T račva / T Module

H50

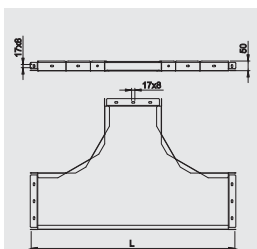

Tip Typ	Širina Width	Visina Height	Debljina Thickness	Šifra artikla Article
	mm	mm	mm	
T PNK 5 5 PL	50	50	1	10030082
T PNK 5 10 PL	100	50	1	10030083
T PNK 5 16 PL	160	50	1	10030084
T PNK 5 20 PL	200	50	1	10030085
T PNK 5 30 PL	300	50	1	10030086
T PNK 5 40 PL	400	50	1	10030087
T PNK 5 50 PL	500	50	1	10030088
T PNK 5 60 PL	600	50	1	10030089
				TC
T PNK 5 5 TC	50	50	1	10020058
T PNK 5 10 TC	100	50	1	10020059
T PNK 5 16 TC	160	50	1	10020060
T PNK 5 20 TC	200	50	1	10020061
T PNK 5 30 TC	300	50	1	10020062
T PNK 5 40 TC	400	50	1	10020063
T PNK 5 50 TC	500	50	1	10020064
T PNK 5 60 TC	600	50	1	10020065



PL Pocinkovani lim / Galvanized sheet **TC** Toplo pocinkovano potapanjem / Hot - dip galvanized

Račva plus / + Connection module

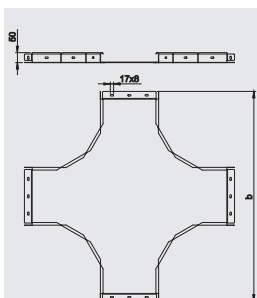

Tip Typ	Širina Width	Visina Height	Debljina Thickness	Šifra artikla Article
	mm	mm	mm	
X PNK 5 5 PL	50	50	1	10030090
X PNK 5 10 PL	100	50	1	10030091
X PNK 5 16 PL	160	50	1	10030092
X PNK 5 20 PL	200	50	1	10030093
X PNK 5 30 PL	300	50	1	10030094
X PNK 5 40 PL	400	50	1	10030095
X PNK 5 50 PL	500	50	1	10030096
X PNK 5 60 PL	600	50	1	10030097
				TC
X PNK 5 5 TC	50	50	1	10020066
X PNK 5 10 TC	100	50	1	10020067
X PNK 5 16 TC	160	50	1	10020068
X PNK 5 20 TC	200	50	1	10020069
X PNK 5 30 TC	300	50	1	10020070
X PNK 5 40 TC	400	50	1	10020071
X PNK 5 50 TC	500	50	1	10020072
X PNK 5 60 TC	600	50	1	10020073



PL Pocinkovani lim / Galvanized sheet **TC** Toplo pocinkovano potapanjem / Hot - dip galvanized

Univerzalna vertikalna krivina / Universal vertical curve

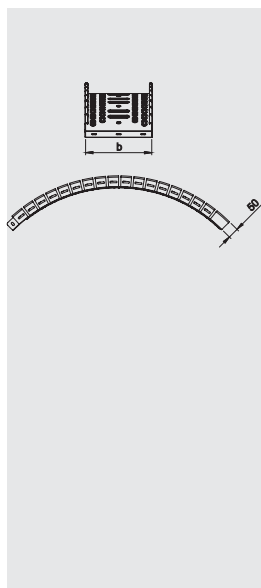
H50

Tip Typ	Širina Width	Visina Height	Debljina Thickness	Šifra artikla Article
	mm	mm	mm	
UVK PNK 5 5 PL	50	50	1	10030098
UVK PNK 5 10 PL	100	50	1	10030099
UVK PNK 5 16 PL	160	50	1	10030100
UVK PNK 5 20 PL	200	50	1	10030101
UVK PNK 5 30 PL	300	50	1	10030102
UVK PNK 5 40 PL	400	50	1	10030103
UVK PNK 5 50 PL	500	50	1	10030104
UVK PNK 5 60 PL	600	50	1	10030105
				TC
UVK PNK 5 5 TC	50	50	1	10020074
UVK PNK 5 10 TC	100	50	1	10020075
UVK PNK 5 16 TC	160	50	1	10020076
UVK PNK 5 20 TC	200	50	1	10020077
UVK PNK 5 30 TC	300	50	1	10020078
UVK PNK 5 40 TC	400	50	1	10020079
UVK PNK 5 50 TC	500	50	1	10020080
UVK PNK 5 60 TC	600	50	1	10020081

PL Pocinkovani lim / Galvanized sheet
 TC Toplo pocinkovano potapanjem / Hot - dip galvanized



Perforirani nosači kablova

Elementi zglobovno vertikalne krivine / Adjustable vertical bend element

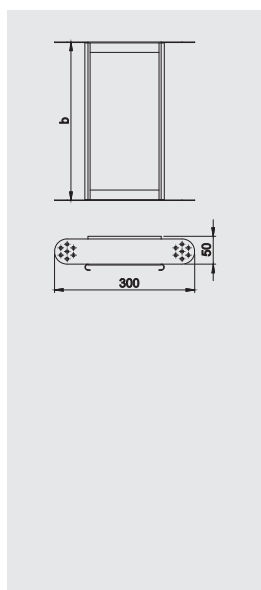

Tip Typ	Širina Width	Visina Height	Debljina Thickness	Šifra artikla Article
	mm	mm	mm	
EZK PNK 5 10 PL	100	50	1	10030106
EZK PNK 5 16 PL	160	50	1	10030107
EZK PNK 5 20 PL	200	50	1	10030108
EZK PNK 5 30 PL	300	50	1	10030109
EZK PNK 5 40 PL	400	50	1	10030110
EZK PNK 5 50 PL	500	50	1	10030111
EZK PNK 5 60 PL	600	50	1	10030112
				TC
EZK PNK 5 10 TC	100	50	1	10020082
EZK PNK 5 16 TC	160	50	1	10020083
EZK PNK 5 20 TC	200	50	1	10020084
EZK PNK 5 30 TC	300	50	1	10020085
EZK PNK 5 40 TC	400	50	1	10020086
EZK PNK 5 50 TC	500	50	1	10020087
EZK PNK 5 60 TC	600	50	1	10020088

PL Pocinkovani lim / Galvanized sheet
 TC Toplo pocinkovano potapanjem / Hot - dip galvanized



Zglobno vertikalna krivina / Adjustable vertical bend

H50

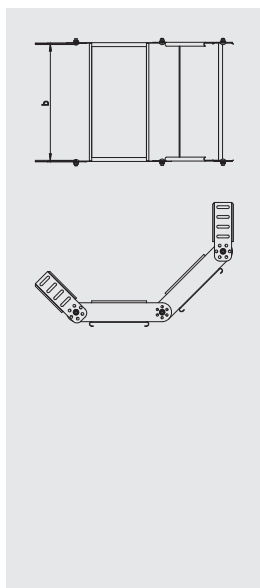

Tip Typ	Širina Width	Visina Height	Debljina Thickness	Šifra artikla Article
	mm	mm	mm	
ZK PNK 5 10 PL	100	50	1	10030113
ZK PNK 5 16 PL	160	50	1	10030114
ZK PNK 5 20 PL	200	50	1	10030115
ZK PNK 5 30 PL	300	50	1	10030116
ZK PNK 5 40 PL	400	50	1	10030117
ZK PNK 5 50 PL	500	50	1	10030118
ZK PNK 5 60 PL	600	50	1	10030119
				TC
ZK PNK 5 10 TC	100	50	1	10020089
ZK PNK 5 16 TC	160	50	1	10020090
ZK PNK 5 20 TC	200	50	1	10020091
ZK PNK 5 30 TC	300	50	1	10020092
ZK PNK 5 40 TC	400	50	1	10020093
ZK PNK 5 50 TC	500	50	1	10020094
ZK PNK 5 60 TC	600	50	1	10020095

PL Pocinkovani lim / Galvanized sheet

TC Toplo pocinkovano potapanjem / Hot - dip galvanized

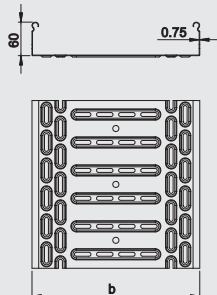

Nosač kablova PNK / PNK cable trays

H60

Tip Typ	Širina Width	Visina Height	Debljina Thickness	Dužina Length	Korisni presek Useful section	Dozvoljeno opterećenje Allowed load			Šifra artikla Article
						1,5 m	2,0 m	2,5 m	
PNK 6 5 300 PL	50	60	0.75	3000	28	121	80	50	10010300
PNK 6 10 300 PL	100	60	0.75	3000	58	120	78	49	10010005
PNK 6 16 300 PL	160	60	0.75	3000	78	123	79	48	10010010
PNK 6 20 300 PL	200	60	0.75	3000	118	132	77	47	10010015
PNK 6 30 300 PL	300	60	0.75	3000	178	112	78	42	10010020
PNK 6 40 300 PL	400	60	1	3000	238	153	123	69	10010024
PNK 6 50 300 PL	500	60	1	3000	298	156	125	62	10010028
PNK 6 60 300 PL	600	60	1	3000	358	158	128	62	10010029
PNK 6 5 200 PL	50	60	0.75	2000	28	121	80	50	10010283
PNK 6 10 200 PL	100	60	0.75	2000	58	121	80	50	10010284
PNK 6 16 200 PL	160	60	0.75	2000	78	123	79	48	10010285
PNK 6 20 200 PL	200	60	0.75	2000	118	132	77	47	10010286
PNK 6 30 200 PL	300	60	0.75	2000	178	112	78	42	10010287
PNK 6 40 200 PL	400	60	1	2000	238	153	123	69	10010288
PNK 6 50 200 PL	500	60	1	2000	298	156	125	62	10010289
PNK 6 60 200 PL	600	60	1	2000	358	158	128	62	10010290

PL Pocinkovani lim / Galvanized sheet

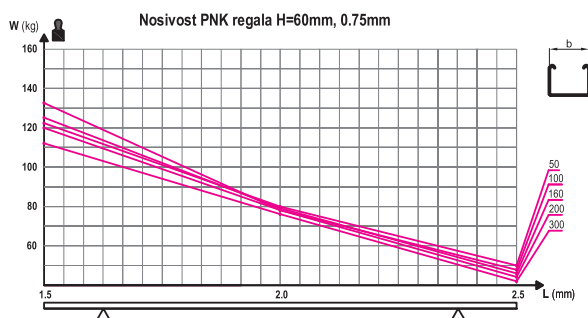

Nosač kablova SNK / SNK cable trays

H60

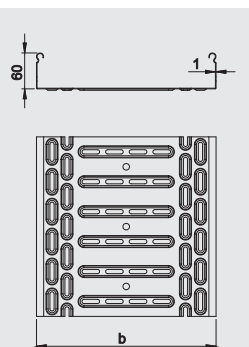

Tip Typ	Širina Width	Visina Height	Debljina Thickness	Dužina Length	Korisni presek Useful section	Dozvoljeno opterećenje Allowed load			Šifra artikla Article
						1.5 m	2.0 m	2.5 m	
	mm	mm	mm	mm	cm ²		kg/m		PL
SNK 6 5 300 PL	50	60	1	3000	28	119	80	49	10070016
SNK 6 10 300 PL	100	60	1	3000	58	121	80	50	10070017
SNK 6 16 300 PL	160	60	1	3000	78	122	79	48	10070018
SNK 6 20 300 PL	200	60	1	3000	118	132	77	47	10070019
SNK 6 30 300 PL	300	60	1	3000	178	112	78	42	10070020
SNK 6 40 300 PL	400	60	1	3000	238	153	123	69	10070021
SNK 6 50 300 PL	500	60	1	3000	298	156	125	62	10070022
SNK 6 60 300 PL	600	60	1	3000	358	158	128	62	10070023
									PL
SNK 6 5 200 PL	50	60	1	2000	28	119	80	49	10070024
SNK 6 10 200 PL	100	60	1	2000	58	121	80	50	10070025
SNK 6 16 200 PL	160	60	1	2000	78	122	79	48	10070026
SNK 6 20 200 PL	200	60	1	2000	118	132	77	47	10070027
SNK 6 30 200 PL	300	60	1	2000	178	112	78	42	10070028
SNK 6 40 200 PL	400	60	1	2000	238	153	123	69	10070029
SNK 6 50 200 PL	500	60	1	2000	298	156	125	62	10070030
SNK 6 60 200 PL	600	60	1	2000	358	158	128	62	10070031
									TC
SNK 6 5 300 TC	50	60	1	3000	28	119	80	49	10020096
SNK 6 10 300 TC	100	60	1	3000	58	121	80	50	10020097
SNK 6 16 300 TC	160	60	1	3000	78	122	79	48	10020098
SNK 6 20 300 TC	200	60	1	3000	118	132	77	47	10020099
SNK 6 30 300 TC	300	60	1	3000	178	112	78	42	10020100
SNK 6 40 300 TC	400	60	1	3000	238	153	123	69	10020101

PL Pocinkovani lim / Galvanized sheet

TC Toplo pocinkovano potapanjem / Hot - dip galvanized

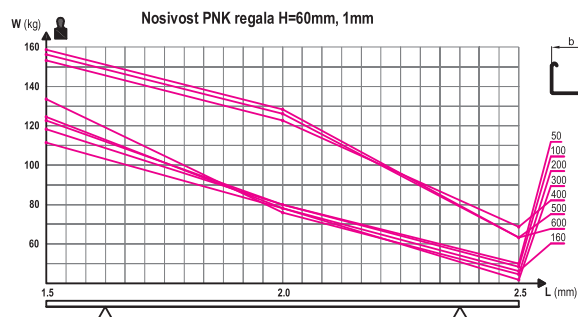

Nosač kablova VNK / VNK cable trays

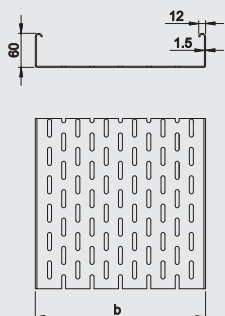
H60

Tip Typ	Širina Width	Visina Height	Debljina Thickness	Dužina Length	Korisni presek Useful section	Dozvoljeno opterećenje Allowed load			Šifra artikla Article
						1,5 m	2,0 m	2,5 m	
VNK 6 5 300 PL	50	60	1.5	3000	28	152	103	53	10080008
VNK 6 10 300 PL	100	60	1.5	3000	58	150	101	51	10080009
VNK 6 16 300 PL	160	60	1.5	3000	78	153	100	48	10080010
VNK 6 20 300 PL	200	60	1.5	3000	118	148	96	49	10080011
VNK 6 30 300 PL	300	60	1.5	3000	178	144	94	47	10080012
VNK 6 40 300 PL	400	60	1.5	3000	238	146	95	48	10080013
VNK 6 50 300 PL	500	60	1.5	3000	298	144	93	50	10080014
VNK 6 60 300 PL	600	60	1.5	3000	358	147	96	52	10080015
TC									
VNK 6 5 300 TC	50	60	1.5	3000	28	152	103	53	10020102
VNK 6 10 300 TC	100	60	1.5	3000	58	150	101	51	10020103
VNK 6 16 300 TC	160	60	1.5	3000	78	153	100	48	10020104
VNK 6 20 300 TC	200	60	1.5	3000	118	148	96	49	10020105
VNK 6 30 300 TC	300	60	1.5	3000	178	144	94	47	10020106
VNK 6 40 300 TC	400	60	1.5	3000	238	146	95	48	10020107
VNK 6 50 300 TC	500	60	1.5	3000	298	144	93	50	10020108
VNK 6 60 300 TC	600	60	1.5	3000	358	147	96	52	10020109

PL Pocinkovani lim / Galvanized sheet
 TC Toplo pocinkovano potapanjem / Hot - dip galvanized

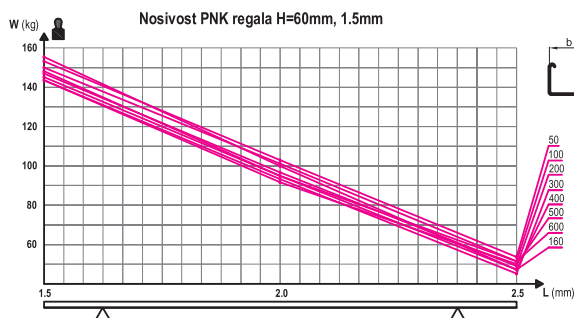

Nosač kablova PNKP / PNKP cable trays

H60

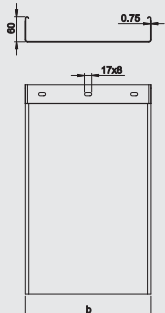

Tip Typ	Širina Width	Visina Height	Debljina Thickness	Dužina Length	Korisni presek Useful section	Dozvoljeno opterećenje Allowed load			Šifra artikla Article
						1.5 m	2.0 m	2.5 m	
PNKP 6 10 300 PL	100	60	0.75	3000	58	110	78	46	10040013
PNKP 6 20 300 PL	200	60	0.75	3000	118	102	75	48	10040014
PNKP 6 30 300 PL	300	60	0.75	3000	178	100	74	44	10040015

PL Pocinkovani lim / Galvanized sheet

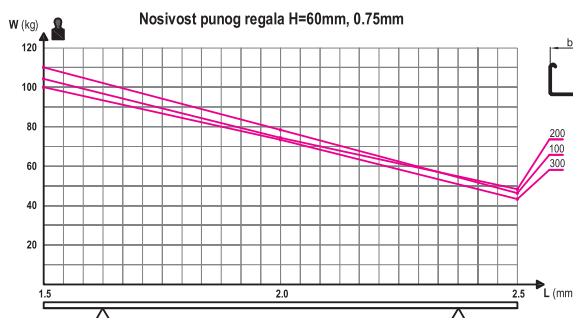

Nosač kablova SNKP / SNKP cable trays

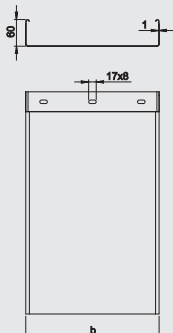

Tip Typ	Širina Width	Visina Height	Debljina Thickness	Dužina Length	Korisni presek Useful section	Dozvoljeno opterećenje Allowed load			Šifra artikla Article
						1.5 m	2.0 m	2.5 m	
SNKP 6 5 300 PL	50	60	1	3000	28	156	104	56	10040016
SNKP 6 10 300 PL	100	60	1	3000	58	152	101	55	10040017
SNKP 6 16 300 PL	160	60	1	3000	78	150	99	53	10040018
SNKP 6 20 300 PL	200	60	1	3000	118	146	98	47	10040019
SNKP 6 30 300 PL	300	60	1	3000	178	144	97	45	10040020
SNKP 6 40 300 PL	400	60	1	3000	238	138	89	42	10040021
SNKP 6 50 300 PL	500	60	1	3000	298	136	87	38	10040022
SNKP 6 60 300 PL	600	60	1	3000	358	132	81	32	10040023
									TC
SNKP 6 5 300 TC	50	60	1	3000	28	156	104	56	10020110
SNKP 6 10 300 TC	100	60	1	3000	58	152	101	55	10020111
SNKP 6 16 300 TC	160	60	1	3000	78	150	99	53	10020112
SNKP 6 20 300 TC	200	60	1	3000	118	146	98	47	10020113
SNKP 6 30 300 TC	300	60	1	3000	178	144	97	45	10020114
SNKP 6 40 300 TC	400	60	1	3000	238	138	89	42	10020115
SNKP 6 50 300 TC	500	60	1	3000	298	136	87	38	10020116
SNKP 6 60 300 TC	600	60	1	3000	358	132	81	32	10020117

PL Pocinkovani lim / Galvanized sheet **TC** Toplo pocinkovano potapanjem / Hot-dip galvanized

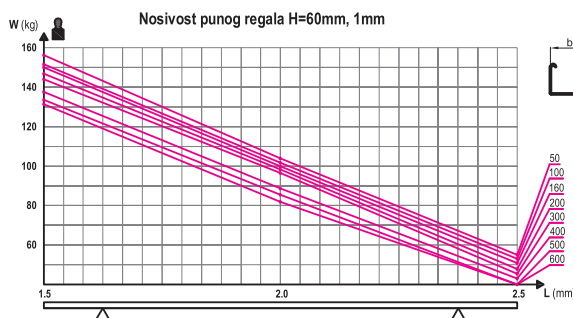

Pregrada / Divider

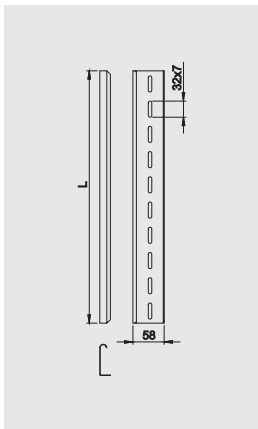
H60

Tip Typ	Visina Height	Duzina Length	Pakovanje Pack kom piece	Šifra artikla Article
P PNK 60 PL	60	3000	10	PL 10030120
P PNK 60 TC	60	3000	10	TC 10020118

PL Pocinkovani lim / Galvanized sheet
 TC Toplo pocinkovano potapanjem / Hot - dip galvanized



Perforirani nosači kablova

Bočna spojnica / Straight connector

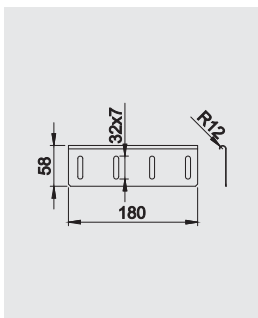

Tip Typ	Visina Height	Pakovanje Pack kom piece	Šifra artikla Article
S PNK 60 PL	60	50	PL 10030121
S PNK 60 TC	60	50	TC 10020119

PL Pocinkovani lim / Galvanized sheet
 TC Toplo pocinkovano potapanjem / Hot - dip galvanized



Lomljiva spojnica / Angle connector

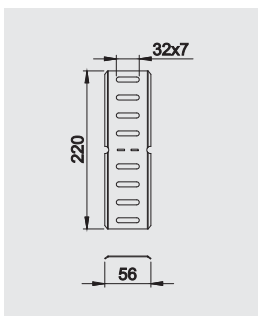

Tip Typ	Visina Height	Pakovanje Pack kom piece	Šifra artikla Article
LS PNK 60 PL	60	50	PL 10030122
LS PNK 60 TC	60	50	TC 10020120

PL Pocinkovani lim / Galvanized sheet
 TC Toplo pocinkovano potapanjem / Hot - dip galvanized



Zglobna spojnica / Adjustable connector

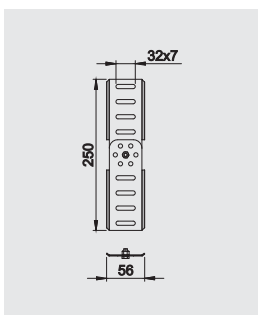

Tip Typ	Visina Height	Pakovanje Pack kom piece	Šifra artikla Article
ZS PNK 60 PL	60	50	PL 10030123
ZS PNK 60 TC	60	50	TC 10020121

PL Pocinkovani lim / Galvanized sheet
 TC Toplo pocinkovano potapanjem / Hot - dip galvanized



Ugradna račva / Add-one tee

H60

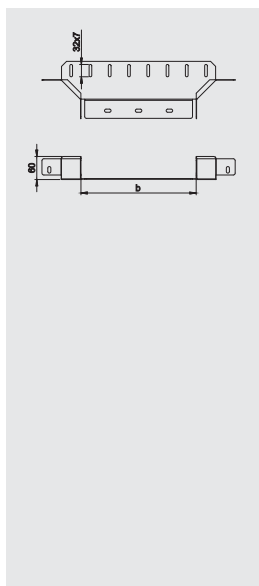

Tip Typ	Širina Width	Visina Height	Debljina Thickness	Šifra artikla Article
	mm	mm	mm	
UR PNK 6 5 PL	50	60	1	10030124
UR PNK 6 10 PL	100	60	1	10030125
UR PNK 6 16 PL	160	60	1	10030126
UR PNK 6 20 PL	200	60	1	10030127
UR PNK 6 30 PL	300	60	1	10030128
UR PNK 6 40 PL	400	60	1	10030129
UR PNK 6 50 PL	500	60	1	10030130
UR PNK 6 60 PL	600	60	1	10030131
				TC
UR PNK 6 5 TC	50	60	1	10020122
UR PNK 6 10 TC	100	60	1	10020123
UR PNK 6 16 TC	160	60	1	10020124
UR PNK 6 20 TC	200	60	1	10020125
UR PNK 6 30 TC	300	60	1	10020126
UR PNK 6 40 TC	400	60	1	10020127
UR PNK 6 50 TC	500	60	1	10020128
UR PNK 6 60 TC	600	60	1	10020129

PL Pocinkovani lim / Galvanized sheet

TC Toplo pocinkovano potapanjem / Hot - dip galvanized



Krivina 45° / Bend 45°

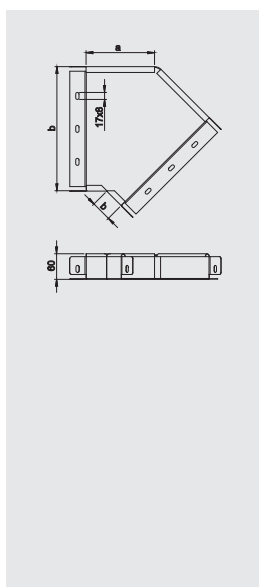

Tip Typ	Širina Width	Visina Height	Debljina Thickness	Šifra artikla Article
	mm	mm	mm	
K45 PNK 6 5 PL	50	60	1	10030132
K45 PNK 6 10 PL	100	60	1	10030133
K45 PNK 6 16 PL	160	60	1	10030134
K45 PNK 6 20 PL	200	60	1	10030135
K45 PNK 6 30 PL	300	60	1	10030136
K45 PNK 6 40 PL	400	60	1	10030137
K45 PNK 6 50 PL	500	60	1	10030138
K45 PNK 6 60 PL	600	60	1	10030139
				TC
K45 PNK 6 5 TC	50	60	1	10020130
K45 PNK 6 10 TC	100	60	1	10020131
K45 PNK 6 16 TC	160	60	1	10020132
K45 PNK 6 20 TC	200	60	1	10020133
K45 PNK 6 30 TC	300	60	1	10020134
K45 PNK 6 40 TC	400	60	1	10020135
K45 PNK 6 50 TC	500	60	1	10020136
K45 PNK 6 60 TC	600	60	1	10020137

PL Pocinkovani lim / Galvanized sheet

TC Toplo pocinkovano potapanjem / Hot - dip galvanized

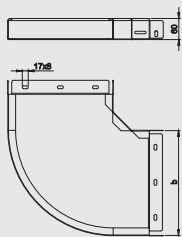

Krivina 90° / Bend 90°

H60

Tip Typ	Širina Width	Visina Height	Debljina Thickness	Šifra artikla Article
	mm	mm	mm	PL
L PNK 6 5 PL	50	60	1	10030140
L PNK 6 10 PL	100	60	1	10030141
L PNK 6 16 PL	160	60	1	10030142
L PNK 6 20 PL	200	60	1	10030143
L PNK 6 30 PL	300	60	1	10030144
L PNK 6 40 PL	400	60	1	10030145
L PNK 6 50 PL	500	60	1	10030146
L PNK 6 60 PL	600	60	1	10030147
				TC
L PNK 6 5 TC	50	60	1	10020138
L PNK 6 10 TC	100	60	1	10020139
L PNK 6 16 TC	160	60	1	10020140
L PNK 6 20 TC	200	60	1	10020141
L PNK 6 30 TC	300	60	1	10020142
L PNK 6 40 TC	400	60	1	10020143
L PNK 6 50 TC	500	60	1	10020144
L PNK 6 60 TC	600	60	1	10020145

PL Pocinkovani lim / Galvanized sheet

TC Toplo pocinkovano potapanjem / Hot - dip galvanized

Perforirani nosači kablova

Ugaona spojnica / Corner connector

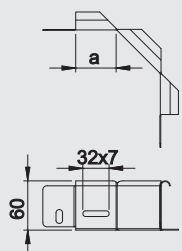

Tip Typ	Širina Width	Visina Height	Debljina Thickness	Šifra artikla Article
	mm	mm	mm	PL
US PNK 6 5 PL	50	60	1	10030148
US PNK 6 10 PL	100	60	1	10030149
US PNK 6 16 PL	160	60	1	10030150
US PNK 6 20 PL	200	60	1	10030151
US PNK 6 30 PL	300	60	1	10030152
US PNK 6 40 PL	400	60	1	10030153
US PNK 6 50 PL	500	60	1	10030154
US PNK 6 60 PL	600	60	1	10030155
				TC
US PNK 6 5 TC	50	60	1	10020146
US PNK 6 10 TC	100	60	1	10020147
US PNK 6 16 TC	160	60	1	10020148
US PNK 6 20 TC	200	60	1	10020149
US PNK 6 30 TC	300	60	1	10020150
US PNK 6 40 TC	400	60	1	10020151
US PNK 6 50 TC	500	60	1	10020152
US PNK 6 60 TC	600	60	1	10020153

PL Pocinkovani lim / Galvanized sheet

TC Toplo pocinkovano potapanjem / Hot - dip galvanized

T račva / T Module

H60

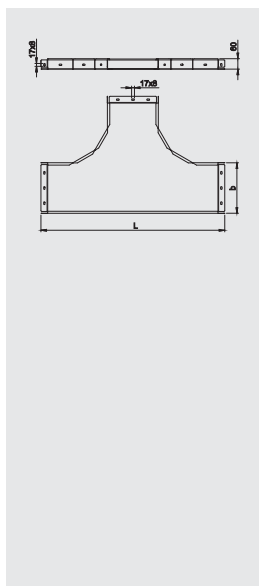

Tip Typ	Širina Width	Visina Height	Debljina Thickness	Šifra artikla Article
	mm	mm	mm	
T PNK 6 5 PL	50	60	1	10030156
T PNK 6 10 PL	100	60	1	10030157
T PNK 6 16 PL	160	60	1	10030158
T PNK 6 20 PL	200	60	1	10030159
T PNK 6 30 PL	300	60	1	10030160
T PNK 6 40 PL	400	60	1	10030161
T PNK 6 50 PL	500	60	1	10030162
T PNK 6 60 PL	600	60	1	10030163
				TC
T PNK 6 5 TC	50	60	1	10020154
T PNK 6 10 TC	100	60	1	10020155
T PNK 6 16 TC	160	60	1	10020156
T PNK 6 20 TC	200	60	1	10020157
T PNK 6 30 TC	300	60	1	10020158
T PNK 6 40 TC	400	60	1	10020159
T PNK 6 50 TC	500	60	1	10020160
T PNK 6 60 TC	600	60	1	10020161

PL Pocinkovani lim / Galvanized sheet

TC Toplo pocinkovano potapanjem / Hot - dip galvanized



Račva plus / + Connection module

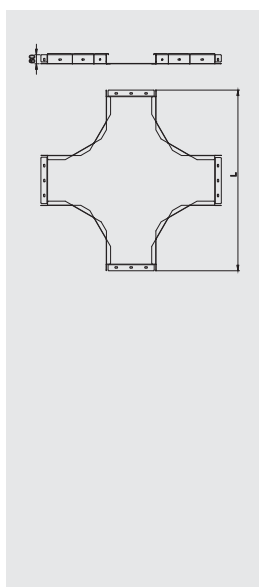

Tip Typ	Širina Width	Visina Height	Debljina Thickness	Šifra artikla Article
	mm	mm	mm	
X PNK 6 5 PL	50	60	1	10030164
X PNK 6 10 PL	100	60	1	10030165
X PNK 6 16 PL	160	60	1	10030166
X PNK 6 20 PL	200	60	1	10030167
X PNK 6 30 PL	300	60	1	10030168
X PNK 6 40 PL	400	60	1	10030169
X PNK 6 50 PL	500	60	1	10030170
X PNK 6 60 PL	600	60	1	10030171
				TC
X PNK 6 5 TC	50	60	1	10020162
X PNK 6 10 TC	100	60	1	10020163
X PNK 6 16 TC	160	60	1	10020164
X PNK 6 20 TC	200	60	1	10020165
X PNK 6 30 TC	300	60	1	10020166
X PNK 6 40 TC	400	60	1	10020167
X PNK 6 50 TC	500	60	1	10020168
X PNK 6 60 TC	600	60	1	10020169

PL Pocinkovani lim / Galvanized sheet

TC Toplo pocinkovano potapanjem / Hot - dip galvanized

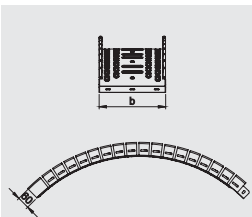

Univerzalna vertikalna krivina / Universal vertical curve

H60

Tip Typ	Širina Width	Visina Height	Debljina Thickness	Šifra artikla Article
	mm	mm	mm	PL
UVK PNK 6 5 PL	50	60	1	10030172
UVK PNK 6 10 PL	100	60	1	10030173
UVK PNK 6 16 PL	160	60	1	10030174
UVK PNK 6 20 PL	200	60	1	10030175
UVK PNK 6 30 PL	300	60	1	10030176
UVK PNK 6 40 PL	400	60	1	10030177
UVK PNK 6 50 PL	500	60	1	10030178
UVK PNK 6 60 PL	600	60	1	10030179
				TC
UVK PNK 6 5 TC	50	60	1	10020170
UVK PNK 6 10 TC	100	60	1	10020171
UVK PNK 6 16 TC	160	60	1	10020172
UVK PNK 6 20 TC	200	60	1	10020173
UVK PNK 6 30 TC	300	60	1	10020174
UVK PNK 6 40 TC	400	60	1	10020175
UVK PNK 6 50 TC	500	60	1	10020176
UVK PNK 6 60 TC	600	60	1	10020177

PL Pocinkovani lim / Galvanized sheet
 TC Toplo pocinkovano potapanjem / Hot - dip galvanized



Perforirani nosači kablova

Elementi zglobovno vertikalne krivine / Adjustable vertical bend element

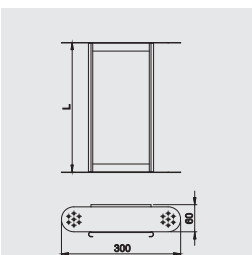

Tip Typ	Širina Width	Visina Height	Debljina Thickness	Šifra artikla Article
	mm	mm	mm	PL
EZK PNK 6 5 PL	50	60	1	10030180
EZK PNK 6 10 PL	100	60	1	10030181
EZK PNK 6 16 PL	160	60	1	10030182
EZK PNK 6 20 PL	200	60	1	10030183
EZK PNK 6 30 PL	300	60	1	10030184
EZK PNK 6 40 PL	400	60	1	10030185
EZK PNK 6 50 PL	500	60	1	10030186
EZK PNK 6 60 PL	600	60	1	10030187
				TC
EZK PNK 6 5 TC	50	60	1	10020178
EZK PNK 6 10 TC	100	60	1	10020179
EZK PNK 6 16 TC	160	60	1	10020180
EZK PNK 6 20 TC	200	60	1	10020181
EZK PNK 6 30 TC	300	60	1	10020182
EZK PNK 6 40 TC	400	60	1	10020183
EZK PNK 6 50 TC	500	60	1	10020184
EZK PNK 6 60 TC	600	60	1	10020185

PL Pocinkovani lim / Galvanized sheet
 TC Toplo pocinkovano potapanjem / Hot - dip galvanized



Zglobno vertikalna krivina / Adjustable vertical bend

H60

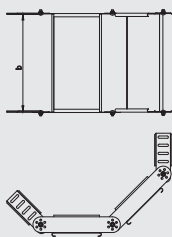

Tip Typ	Širina Width	Visina Height	Debljina Thickness	Šifra artikla Article
	mm	mm	mm	
ZK PNK 6 10 PL	100	60	1	10030188
ZK PNK 6 16 PL	160	60	1	10030189
ZK PNK 6 20 PL	200	60	1	10030190
ZK PNK 6 30 PL	300	60	1	10030191
ZK PNK 6 40 PL	400	60	1	10030192
ZK PNK 6 50 PL	500	60	1	10030193
ZK PNK 6 60 PL	600	60	1	10030194
				TC
ZK PNK 6 10 TC	100	60	1	10020186
ZK PNK 6 16 TC	160	60	1	10020187
ZK PNK 6 20 TC	200	60	1	10020188
ZK PNK 6 30 TC	300	60	1	10020189
ZK PNK 6 40 TC	400	60	1	10020190
ZK PNK 6 50 TC	500	60	1	10020191
ZK PNK 6 60 TC	600	60	1	10020192

PL Pocinkovani lim / Galvanized sheet

TC Toplo pocinkovano potapanjem / Hot - dip galvanized

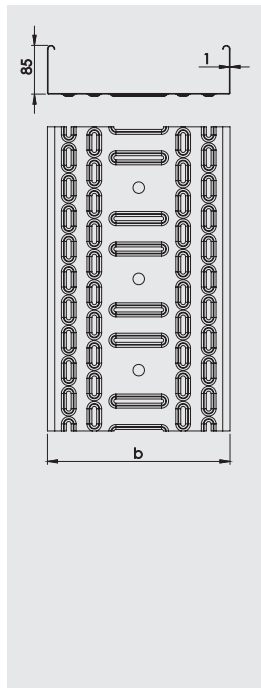

Nosač kablova SNK / SNK cable trays

H85

Tip Type	Širina Width b mm	Visina Height mm	Debljina Thickness mm	Dužina Length mm	Korisni presek Useful section cm ²	Dozvoljeno opterećenje Allowed load			Šifra artikla Article PL
						1.5 m	2.0 m	2.5 m	
SNK 8 10 300 PL	100	85	1	3000	80	175	118	56	10070032
SNK 8 16 300 PL	160	85	1	3000	130	176	120	50	10070033
PNK 8 20 300 PL	200	85	1	3000	160	177	121	53	10070034
PNK 8 30 300 PL	300	85	1	3000	240	175	109	49	10070035
PNK 8 40 300 PL	400	85	1	3000	320	182	108	49	10070036
PNK 8 50 300 PL	500	85	1	3000	400	181	112	52	10070037
PNK 8 60 300 PL	600	85	1	3000	480	178	111	52	10070038

PL Pocinkovani lim / Galvanized sheet

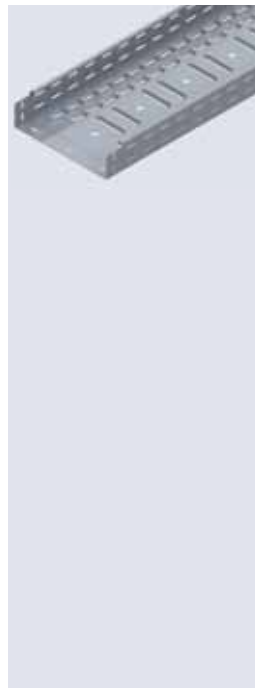
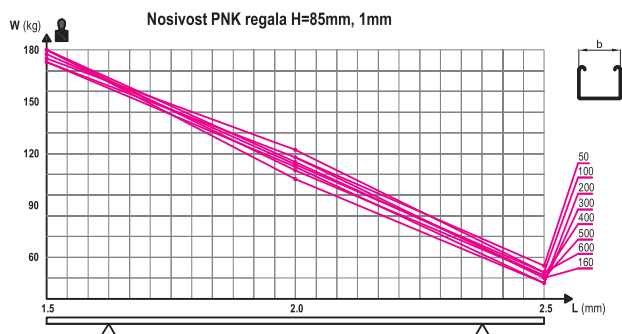

Perforirani nosači kablova

Nosač kablova VNK / VNK cable trays

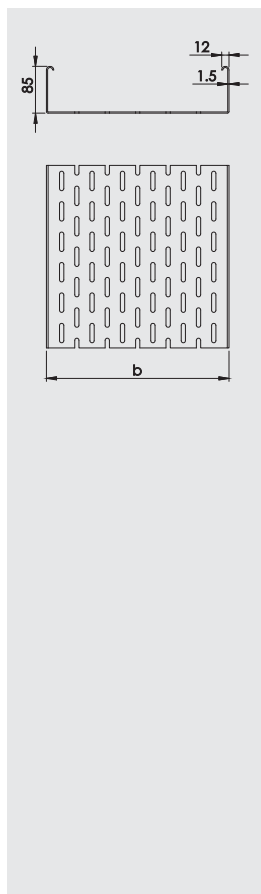

Tip Type	Širina Width b mm	Visina Height mm	Debljina Thickness mm	Dužina Length mm	Korisni presek Useful section cm ²	Dozvoljeno opterećenje Allowed load			Šifra artikla Article
						1.5 m	2.0 m	2.5 m	
VNK 8 10 300 PL	100	85	1.5	3000	80	280	225	152	10080016
VNK 8 16 300 PL	160	85	1.5	3000	130	277	222	150	10080017
VNK 8 20 300 PL	200	85	1.5	3000	160	274	223	148	10080018
VNK 8 30 300 PL	300	85	1.5	3000	240	270	228	144	10080019
VNK 8 40 300 PL	400	85	1.5	3000	320	272	230	145	10080020
VNK 8 50 300 PL	500	85	1.5	3000	400	275	224	147	10080021
VNK 8 60 300 PL	600	85	1.5	3000	480	273	221	140	10080022
									TC
VNK 8 10 200 PL	100	85	1.5	3000	80	280	225	152	10020193
VNK 8 16 200 PL	160	85	1.5	3000	130	277	222	150	10020194
VNK 8 20 200 PL	200	85	1.5	3000	160	274	223	148	10020195
VNK 8 30 200 PL	300	85	1.5	3000	240	270	228	144	10020196
VNK 8 40 200 PL	400	85	1.5	3000	320	272	230	145	10020197
VNK 8 50 200 PL	500	85	1.5	3000	400	275	224	147	10020198
VNK 8 60 200 PL	600	85	1.5	3000	480	273	221	140	10020199

PL Pocinkovani lim / Galvanized sheet **TC** Toplo pocinkovano potapanjem / Hot-dip galvanized

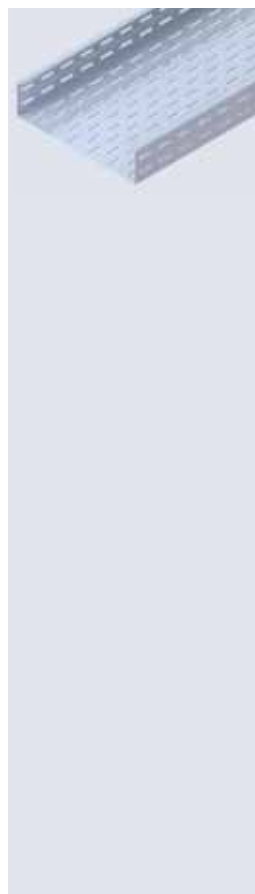
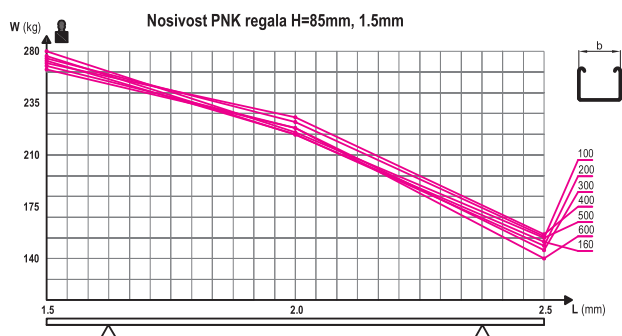

Nosač kablova SNKP / SNKP cable trays

H85

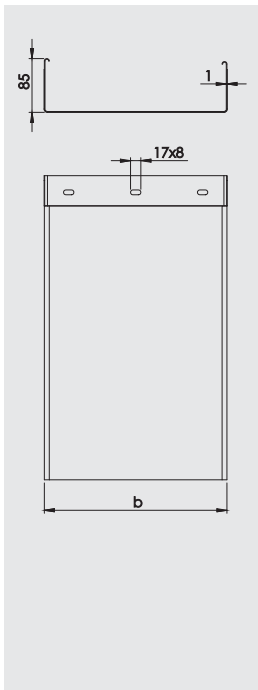

Tip Typ	Širina Width	Visina Height	Debljina Thickness	Dužina Length	Korisni presek Useful section	Dozvoljeno opterećenje Allowed load			Šifra artikla Article
						1.5 m	2.0 m	2.5 m	
SNKP 8 10 300 PL	100	85	1	3000	80	175	118	56	10040024
SNKP 8 16 300 PL	160	85	1	3000	130	177	121	53	10040025
SNKP 8 20 300 PL	200	85	1	3000	160	177	121	53	10040026
SNKP 8 30 300 PL	300	85	1	3000	240	175	109	49	10040027
SNKP 8 40 300 PL	400	85	1	3000	320	182	108	49	10040028
SNKP 8 50 300 PL	500	85	1	3000	400	181	112	52	10040029
SNKP 8 60 300 PL	600	85	1	3000	480	178	111	52	10040030

PL Pocinkovani lim / Galvanized sheet

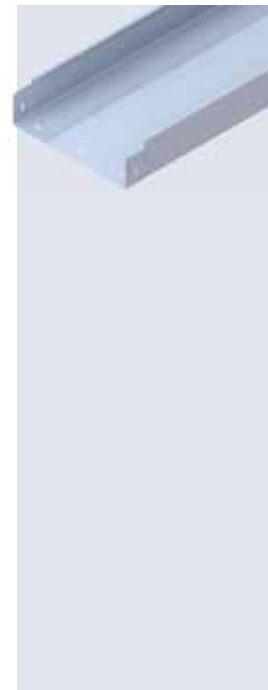
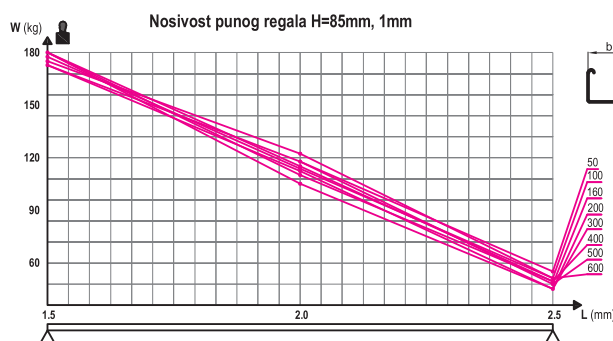

Nosač kablova VNKP / VNKP cable trays

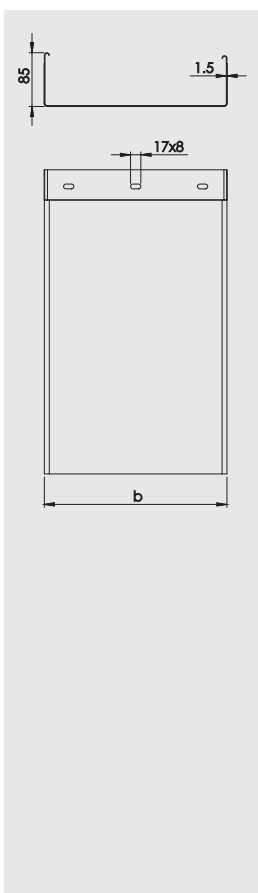

Tip Typ	Širina Width	Visina Height	Debljina Thickness	Dužina Length	Korisni presek Useful section	Dozvoljeno opterećenje Allowed load			Šifra artikla Article
						1.5 m	2.0 m	2.5 m	
VNKP 8 10 300 PL	100	85	1.5	3000	80	280	225	152	10040031
VNKP 8 16 300 PL	160	85	1.5	3000	130	277	222	150	10040032
VNKP 8 20 300 PL	200	85	1.5	3000	160	274	223	148	10040033
VNKP 8 30 300 PL	300	85	1.5	3000	240	270	228	144	10040034
VNKP 8 40 300 PL	400	85	1.5	3000	320	272	230	145	10040035
VNKP 8 50 300 PL	500	85	1.5	3000	400	275	224	147	10040036
VNKP 8 60 300 PL	600	85	1.5	3000	480	273	221	140	10040037
TC									
VNKP 8 10 300 TC	100	85	1.5	3000	80	280	225	152	10020200
VNKP 8 16 300 TC	160	85	1.5	3000	130	277	222	150	10020201
VNKP 8 20 300 TC	200	85	1.5	3000	160	274	223	148	10020202
VNKP 8 30 300 TC	300	85	1.5	3000	240	270	228	144	10020203
VNKP 8 40 300 TC	400	85	1.5	3000	320	272	230	145	10020204
VNKP 8 50 300 TC	500	85	1.5	3000	400	275	224	147	10020205
VNKP 8 60 300 TC	600	85	1.5	3000	480	273	221	140	10020206

PL Pocinkovani lim / Galvanized sheet TC Toplo pocinkovano potapanjem / Hot-dip galvanized

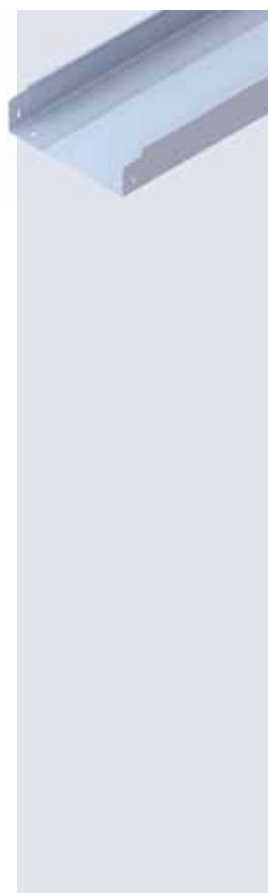
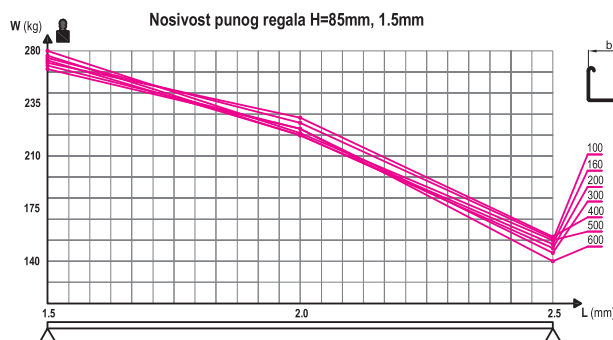

Pregrada / Divider

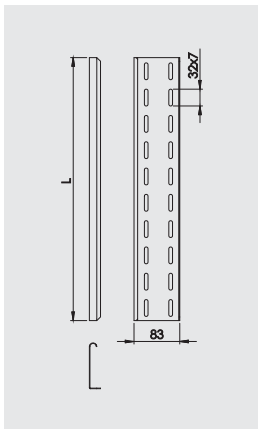
H85

Tip Typ	Visina Height	Duzina Length	Pakovanje Pack kom piece	Šifra artikla Article
P PNK 85 PL	85 mm	3000 mm	10	PL 10030195
P PNK 85 TC	85 mm	3000 mm	10	TC 10020207

PL Pocinkovani lim / Galvanized sheet
 TC Toplo pocinkovano potapanjem / Hot - dip galvanized



Perforirani nosači kablova

Bočna spojnica / Straight connector

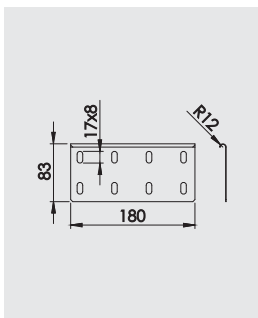

Tip Typ	Visina Height	Pakovanje Pack kom piece	Šifra artikla Article
S PNK 85 PL	85 mm	50	PL 10030196
S PNK 85 TC	85 mm	50	TC 10020208

PL Pocinkovani lim / Galvanized sheet
 TC Toplo pocinkovano potapanjem / Hot - dip galvanized



Lomljiva spojnica / Angle connector

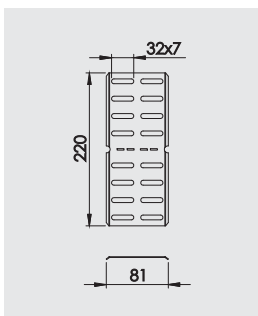

Tip Typ	Visina Height	Pakovanje Pack kom piece	Šifra artikla Article
LS PNK 85 PL	85 mm	50	PL 10030197
LS PNK 85 TC	85 mm	50	TC 10020209

PL Pocinkovani lim / Galvanized sheet
 TC Toplo pocinkovano potapanjem / Hot - dip galvanized



Zglobna spojnica / Adjustable connector

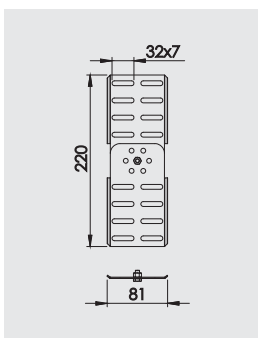

Tip Typ	Visina Height	Pakovanje Pack kom piece	Šifra artikla Article
ZS PNK 85 PL	85 mm	50	PL 10030198
ZS PNK 85 TC	85 mm	50	TC 10020210

PL Pocinkovani lim / Galvanized sheet
 TC Toplo pocinkovano potapanjem / Hot - dip galvanized



Ugradna račva / Add-one tee

H85

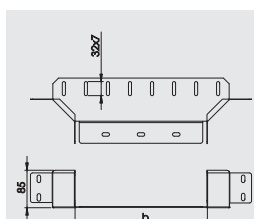

Tip Typ	Širina Width b mm	Visina Height mm	Debljina Thickness mm	Šifra artikla Article
				PL
UR PNK 8 10 PL	100	85	1	10030199
UR PNK 8 16 PL	160	85	1	10030200
UR PNK 8 20 PL	200	85	1	10030201
UR PNK 8 30 PL	300	85	1	10030202
UR PNK 8 40 PL	400	85	1	10030203
UR PNK 8 50 PL	500	85	1	10030204
UR PNK 8 60 PL	600	85	1	10030205
				TC
UR PNK 8 10 TC	100	85	1	10020211
UR PNK 8 16 TC	160	85	1	10020212
UR PNK 8 20 TC	200	85	1	10020213
UR PNK 8 30 TC	300	85	1	10020214
UR PNK 8 40 TC	400	85	1	10020215
UR PNK 8 50 TC	500	85	1	10020216
UR PNK 8 60 TC	600	85	1	10020217

PL Pocinkovani lim / Galvanized sheet **TC** Toplo pocinkovano potapanjem / Hot - dip galvanized



Krivina 45° / Bend 45°

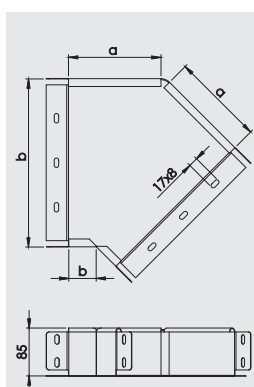

Tip Typ	Širina Width b mm	Visina Height mm	Debljina Thickness mm	Šifra artikla Article
				PL
K45 PNK 8 10 PL	100	85	1	10030206
K45 PNK 8 16 PL	160	85	1	10030207
K45 PNK 8 20 PL	200	85	1	10030208
K45 PNK 8 30 PL	300	85	1	10030209
K45 PNK 8 40 PL	400	85	1	10030210
K45 PNK 8 50 PL	500	85	1	10030211
K45 PNK 8 60 PL	600	85	1	10030212
				TC
K45 PNK 8 10 TC	100	85	1	10020218
K45 PNK 8 16 TC	160	85	1	10020219
K45 PNK 8 20 TC	200	85	1	10020220
K45 PNK 8 30 TC	300	85	1	10020221
K45 PNK 8 40 TC	400	85	1	10020222
K45 PNK 8 50 TC	500	85	1	10020223
K45 PNK 8 60 TC	600	85	1	10020224

PL Pocinkovani lim / Galvanized sheet **TC** Toplo pocinkovano potapanjem / Hot - dip galvanized

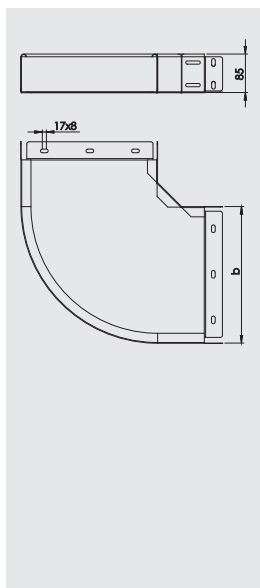

Krivina 90° / Bend 90°

H85

Tip Typ	Širina Width b mm	Visina Height mm	Debljina Thickness mm	Šifra artikla Article
				PL
L PNK 8 10 PL	100	85	1	10030213
L PNK 8 16 PL	160	85	1	10030214
L PNK 8 20 PL	200	85	1	10030215
L PNK 8 30 PL	300	85	1	10030216
L PNK 8 40 PL	400	85	1	10030217
L PNK 8 50 PL	500	85	1	10030218
L PNK 8 60 PL	600	85	1	10030219
				TC
L PNK 8 10 TC	100	85	1	10020225
L PNK 8 16 TC	160	85	1	10020226
L PNK 8 20 TC	200	85	1	10020227
L PNK 8 30 TC	300	85	1	10020228
L PNK 8 40 TC	400	85	1	10020229
L PNK 8 50 TC	500	85	1	10020230
L PNK 8 60 TC	600	85	1	10020231

PL Pocinkovani lim / Galvanized sheet
 TC Toplo pocinkovano potapanjem / Hot - dip galvanized



Perforirani nosači kablova

Ugaona spojnica / Corner connector

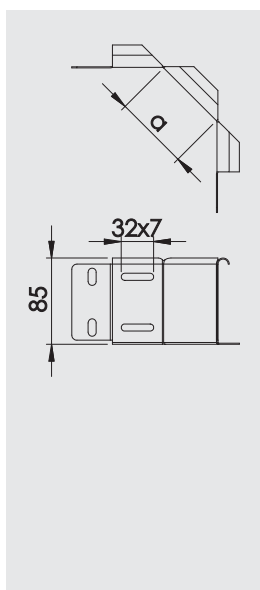

Tip Typ	Širina Width b mm	Visina Height mm	Debljina Thickness mm	Šifra artikla Article
				PL
US PNK 8 10 PL	100	85	1	10030220
US PNK 8 16 PL	160	85	1	10030221
US PNK 8 20 PL	200	85	1	10030222
US PNK 8 30 PL	300	85	1	10030223
US PNK 8 40 PL	400	85	1	10030224
US PNK 8 50 PL	500	85	1	10030225
US PNK 8 60 PL	600	85	1	10030226
				TC
US PNK 8 10 TC	100	85	1	10020232
US PNK 8 16 TC	160	85	1	10020233
US PNK 8 20 TC	200	85	1	10020234
US PNK 8 30 TC	300	85	1	10020235
US PNK 8 40 TC	400	85	1	10020236
US PNK 8 50 TC	500	85	1	10020237
US PNK 8 60 TC	600	85	1	10020238

PL Pocinkovani lim / Galvanized sheet
 TC Toplo pocinkovano potapanjem / Hot - dip galvanized

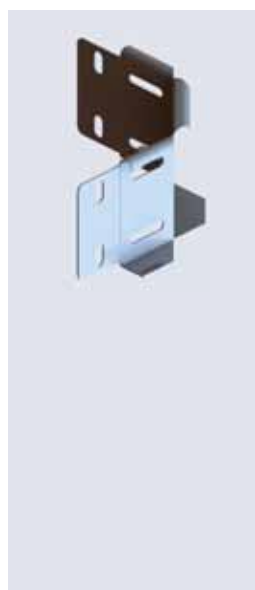

T račva / T Module

H85

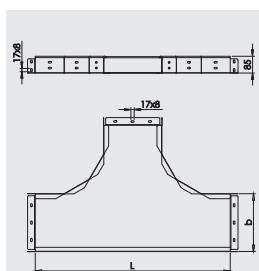

Tip Typ	Širina Width b mm	Visina Height mm	Debljina Thickness mm	Šifra artikla Article
				PL
T PNK 8 10 PL	100	85	1	10030227
T PNK 8 16 PL	160	85	1	10030228
T PNK 8 20 PL	200	85	1	10030229
T PNK 8 30 PL	300	85	1	10030230
T PNK 8 40 PL	400	85	1	10030231
T PNK 8 50 PL	500	85	1	10030232
T PNK 8 60 PL	600	85	1	10030233
				TC
T PNK 8 10 TC	100	85	1	10020239
T PNK 8 16 TC	160	85	1	10020240
T PNK 8 20 TC	200	85	1	10020241
T PNK 8 30 TC	300	85	1	10020242
T PNK 8 40 TC	400	85	1	10020243
T PNK 8 50 TC	500	85	1	10020244
T PNK 8 60 TC	600	85	1	10020245

PL Pocinkovani lim / Galvanized sheet

TC Toplo pocinkovano potapanjem / Hot - dip galvanized



Račva plus / + Connection module

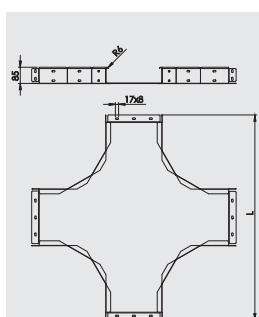

Tip Typ	Širina Width b mm	Visina Height mm	Debljina Thickness mm	Šifra artikla Article
				PL
X PNK 8 10 PL	100	85	1	10030234
X PNK 8 16 PL	160	85	1	10030235
X PNK 8 20 PL	200	85	1	10030236
X PNK 8 30 PL	300	85	1	10030237
X PNK 8 40 PL	400	85	1	10030238
X PNK 8 50 PL	500	85	1	10030239
X PNK 8 60 PL	600	85	1	10030240
				TC
X PNK 8 10 TC	100	85	1	10020246
X PNK 8 16 TC	160	85	1	10020247
X PNK 8 20 TC	200	85	1	10020248
X PNK 8 30 TC	300	85	1	10020249
X PNK 8 40 TC	400	85	1	10020250
X PNK 8 50 TC	500	85	1	10020251
X PNK 8 60 TC	600	85	1	10020252

PL Pocinkovani lim / Galvanized sheet

TC Toplo pocinkovano potapanjem / Hot - dip galvanized

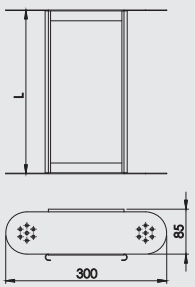

Elementi zglobno vertikalne krivine / Adjustable vertical bend element

H85

Tip Typ	Širina Width	Visina Height	Debljina Thickness	Šifra artikla Article
	mm	mm	mm	PL
EZK PNK 8 10 PL	100	85	1	10030241
EZK PNK 8 16 PL	160	85	1	10030242
EZK PNK 8 20 PL	200	85	1	10030243
EZK PNK 8 30 PL	300	85	1	10030244
EZK PNK 8 40 PL	400	85	1	10030245
EZK PNK 8 50 PL	500	85	1	10030246
EZK PNK 8 60 PL	600	85	1	10030247
				TC
EZK PNK 8 10 TC	100	85	1	10020260
EZK PNK 8 16 TC	160	85	1	10020261
EZK PNK 8 20 TC	200	85	1	10020262
EZK PNK 8 30 TC	300	85	1	10020263
EZK PNK 8 40 TC	400	85	1	10020264
EZK PNK 8 50 TC	500	85	1	10020265
EZK PNK 8 60 TC	600	85	1	10020266

PL Pocinkovani lim / Galvanized sheet
 TC Toplo pocinkovano potapanjem / Hot - dip galvanized



Perforirani nosači kablova

Zglobno vertikalna krivina / Adjustable vertical bend

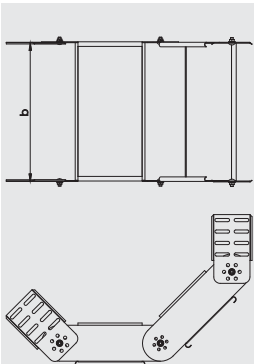

Tip Typ	Širina Width	Visina Height	Debljina Thickness	Šifra artikla Article
	mm	mm	mm	PL
ZK PNK 8 10 PL	100	85	1	10030248
ZK PNK 8 16 PL	160	85	1	10030249
ZK PNK 8 20 PL	200	85	1	10030250
ZK PNK 8 30 PL	300	85	1	10030251
ZK PNK 8 40 PL	400	85	1	10030252
ZK PNK 8 50 PL	500	85	1	10030253
ZK PNK 8 60 PL	600	85	1	10030254
				TC
ZK PNK 8 10 TC	100	85	1	10020253
ZK PNK 8 16 TC	160	85	1	10020254
ZK PNK 8 20 TC	200	85	1	10020255
ZK PNK 8 30 TC	300	85	1	10020256
ZK PNK 8 40 TC	400	85	1	10020257
ZK PNK 8 50 TC	500	85	1	10020258
ZK PNK 8 60 TC	600	85	1	10020259

PL Pocinkovani lim / Galvanized sheet
 TC Toplo pocinkovano potapanjem / Hot - dip galvanized



Nosač kablova SNK / SNK cable trays

H110

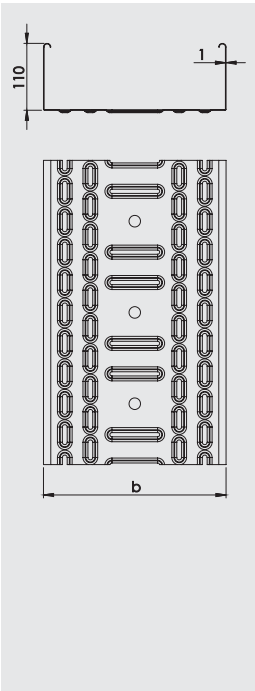

Tip Typ	Širina Width	Visina Height	Debljina Thickness	Dužina Length	Korisni presek Useful section	Dozvoljeno opterećenje Allowed load			Šifra artikla Article
						1.5 m	2.0 m	2.5 m	
SNK 11 10 300 PL	100	110	1	3000	100	191	135	80	10070039
SNK 11 16 300 PL	160	110	1	3000	160	190	132	81	10070040
SNK 11 20 300 PL	200	110	1	3000	200	188	129	82	10070041
SNK 11 30 300 PL	300	110	1	3000	300	183	131	78	10070042
SNK 11 40 300 PL	400	110	1	3000	400	185	130	75	10070043
SNK 11 50 300 PL	500	110	1	3000	500	188	141	75	10070044
SNK 11 60 300 PL	600	110	1	3000	600	182	130	74	10070045

PL Pocinkovani lim / Galvanized sheet

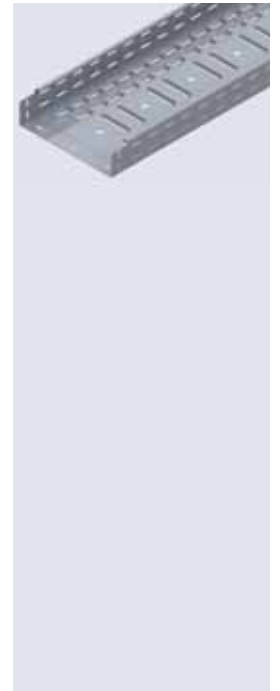
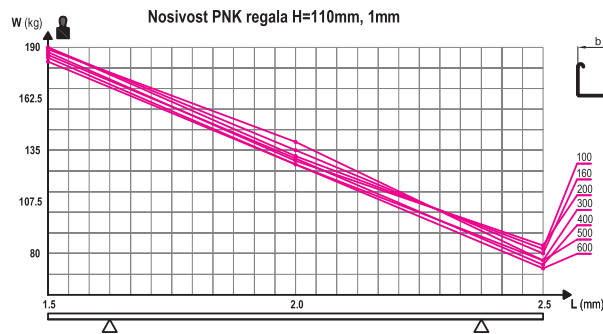

Nosač kablova VNK / VNK cable trays

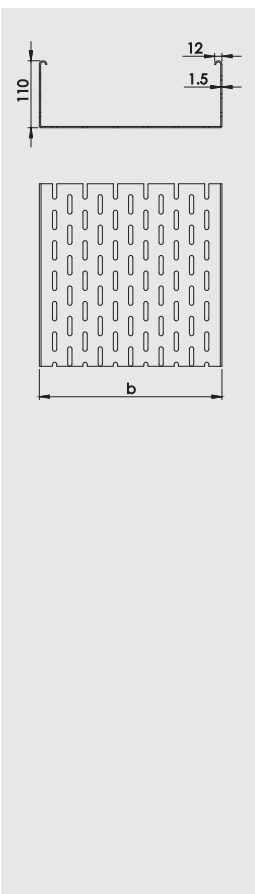

Tip Typ	Širina Width	Visina Height	Debljina Thickness	Dužina Length	Korisni presek Useful section	Dozvoljeno opterećenje Allowed load			Šifra artikla Article
						1.5 m	2.0 m	2.5 m	
VNK 11 10 300 PL	100	110	1.5	3000	100	300	124	85	10080023
VNK 11 16 300 PL	160	110	1.5	3000	160	297	122	82	10080024
VNK 11 20 300 PL	200	110	1.5	3000	200	294	120	80	10080025
VNK 11 30 300 PL	300	110	1.5	3000	300	293	117	78	10080026
VNK 11 40 300 PL	400	110	1.5	3000	400	295	113	75	10080027
VNK 11 50 300 PL	500	110	1.5	3000	500	292	112	75	10080028
VNK 11 60 300 PL	600	110	1.5	3000	600	290	110	74	10080029
TC									
VNK 11 10 300 TC	100	110	1.5	3000	100	300	124	85	10020267
VNK 11 16 300 TC	160	110	1.5	3000	160	297	122	82	10020268
VNK 11 20 300 TC	200	110	1.5	3000	200	294	120	80	10020269
VNK 11 30 300 TC	300	110	1.5	3000	300	293	117	78	10020270
VNK 11 40 300 TC	400	110	1.5	3000	400	295	113	75	10020271
VNK 11 50 300 TC	500	110	1.5	3000	500	292	112	75	10020272
VNK 11 60 300 TC	600	110	1.5	3000	600	290	110	74	10020273

PL Pocinkovani lim / Galvanized sheet TC Toplo pocinkovano potapanjem / Hot - dip galvanized

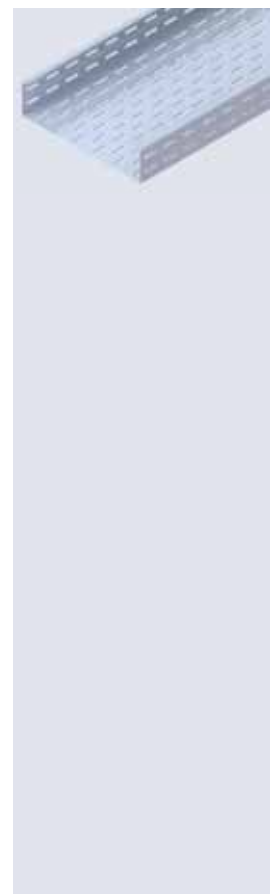
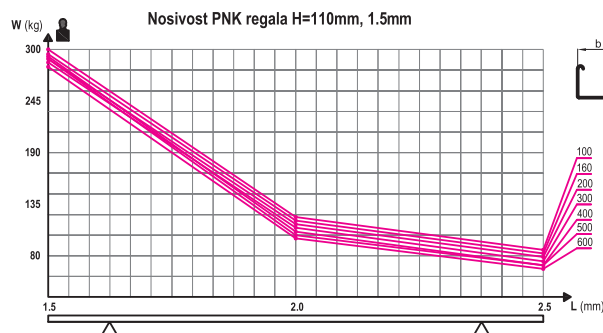

Nosač kablova SNKP / SNKP cable trays

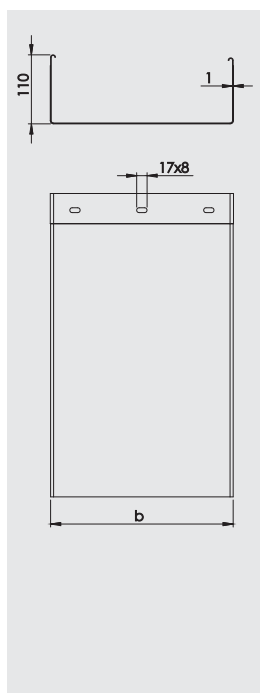
H110

Tip Typ	Širina Width	Visina Height	Debljina Thickness	Dužina Length	Korisni presek Useful section	Dozvoljeno opterećenje Allowed load			Šifra artikla Article
						1.5 m	2.0 m	2.5 m	
PNKP 11 10 300 PL	100	110	1	3000	100	191	135	80	10040038
PNKP 11 16 300 PL	160	110	1	3000	160	190	132	81	10040039
PNKP 11 20 300 PL	200	110	1	3000	200	188	129	82	10040040
PNKP 11 30 300 PL	300	110	1	3000	300	183	131	78	10040041
PNKP 11 40 300 PL	400	110	1	3000	400	185	130	75	10040042
PNKP 11 50 300 PL	500	110	1	3000	500	188	141	75	10040043
PNKP 11 60 300 PL	600	110	1	3000	600	182	130	74	10040044

PL Pocinkovani lim / Galvanized sheet

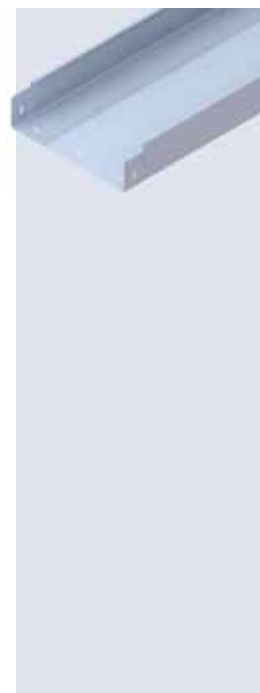
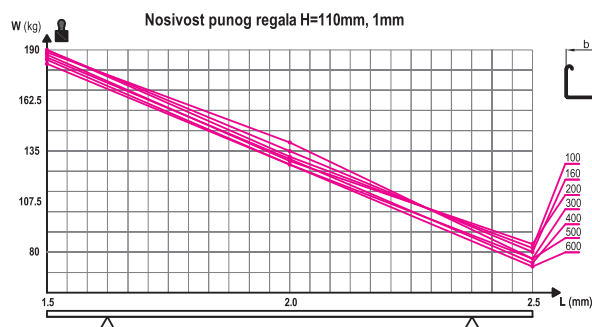

Perforirani nosači kablova

Nosač kablova VNKP / VNKP cable trays

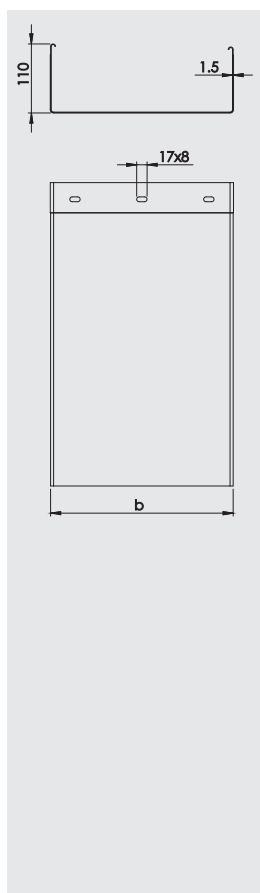

Tip Typ	Širina Width	Visina Height	Debljina Thickness	Dužina Length	Korisni presek Useful section	Dozvoljeno opterećenje Allowed load			Šifra artikla Article
						1.5 m	2.0 m	2.5 m	
VNKP 11 10 300 PL	100	110	1.5	3000	100	300	124	85	10040045
VNKP 11 16 300 PL	160	110	1.5	3000	160	297	122	82	10040046
VNKP 11 20 300 PL	200	110	1.5	3000	200	294	120	80	10040047
VNKP 11 30 300 PL	300	110	1.5	3000	300	293	117	78	10040048
VNKP 11 40 300 PL	400	110	1.5	3000	400	295	113	75	10040049
VNKP 11 50 300 PL	500	110	1.5	3000	500	292	112	75	10040050
VNKP 11 60 300 PL	600	110	1.5	3000	600	290	110	74	10040051
									TC
VNKP 11 10 300 TC	100	110	1.5	3000	80	300	124	85	10020274
VNKP 11 16 300 TC	160	110	1.5	3000	130	297	122	82	10020275
VNKP 11 20 300 TC	200	110	1.5	3000	160	294	120	80	10020276
VNKP 11 30 300 TC	300	110	1.5	3000	240	293	117	78	10020277
VNKP 11 40 300 TC	400	110	1.5	3000	320	295	113	75	10020278
VNKP 11 50 300 TC	500	110	1.5	3000	400	292	112	75	10020279
VNKP 11 60 300 TC	600	110	1.5	3000	480	290	110	74	10020280

PL Pocinkovani lim / Galvanized sheet **TC** Toplo pocinkovano potapanjem / Hot - dip galvanized

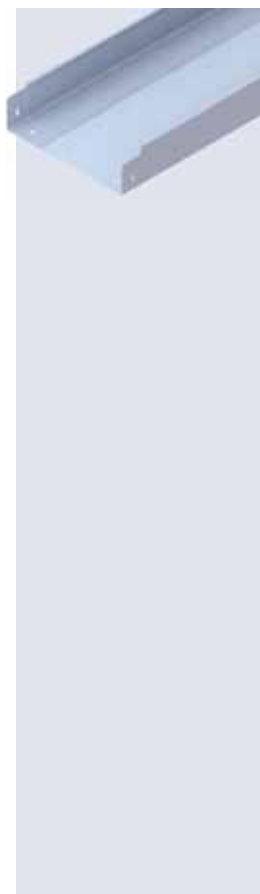
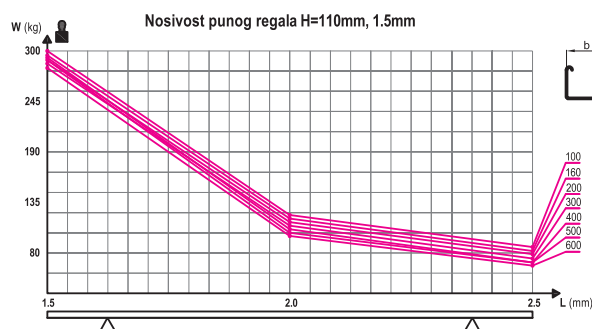

Pregrada / Divider

H110

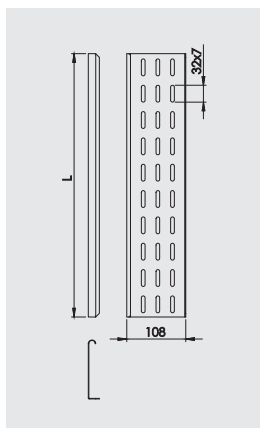

Tip Typ	Visina Height	Dužina Length	Pakovanje Pack kom piece	Šifra artikla Article
P PNK 110 PL	110	3000	50	PL 10030255
P PNK 110 TC	110	3000	50	TC 10020281

PL Pocinkovani lim / Galvanized sheet **TC** Toplo pocinkovano potapanjem / Hot - dip galvanized

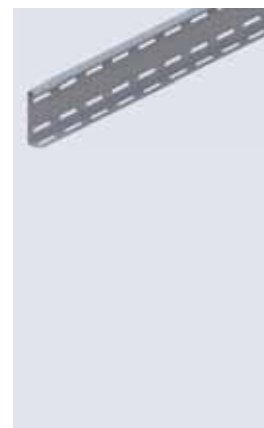

Bočna spojnica / Straight connector

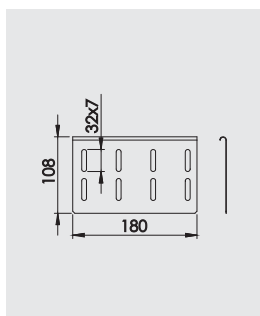

Tip Typ	Visina Height	Pakovanje Pack kom piece	Šifra artikla Article
S PNK 110 PL	110	50	PL 10030256
S PNK 110 TC	110	50	TC 10020282

PL Pocinkovani lim / Galvanized sheet **TC** Toplo pocinkovano potapanjem / Hot - dip galvanized



Lomljiva spojnica / Angle connector

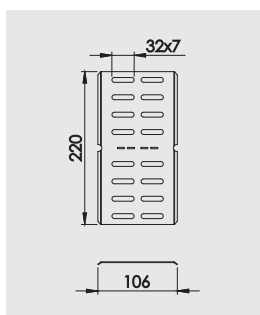

Tip Typ	Visina Height	Pakovanje Pack kom piece	Šifra artikla Article
LS PNK 110 PL	110	50	PL 10030257
LS PNK 110 TC	110	50	TC 10020283

PL Pocinkovani lim / Galvanized sheet **TC** Toplo pocinkovano potapanjem / Hot - dip galvanized



Zglobna spojnica / Adjustable connector

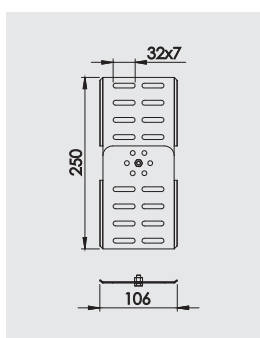

Tip Typ	Visina Height	Pakovanje Pack kom piece	Šifra artikla Article
ZS PNK 110 PL	110	50	PL 10030258
ZS PNK 110 TC	110	50	TC 10020284

PL Pocinkovani lim / Galvanized sheet **TC** Toplo pocinkovano potapanjem / Hot - dip galvanized



Ugradna račva / Add-one tee

H110

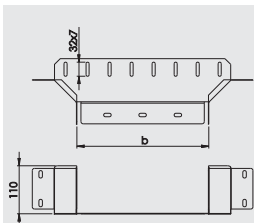

Tip Typ	Širina Width	Visina Height	Debljina Thickness	Šifra artikla Article
	mm	mm	mm	
PL				
UR PNK 11 10 PL	100	110	1	10030259
UR PNK 11 16 PL	160	110	1	10030260
UR PNK 11 20 PL	200	110	1	10030261
UR PNK 11 30 PL	300	110	1	10030262
UR PNK 11 40 PL	400	110	1	10030263
UR PNK 11 50 PL	500	110	1	10030264
UR PNK 11 60 PL	600	110	1	10030265
TC				
UR PNK 11 10 TC	100	110	1	10020285
UR PNK 11 16 TC	160	110	1	10020286
UR PNK 11 20 TC	200	110	1	10020287
UR PNK 11 30 TC	300	110	1	10020288
UR PNK 11 40 TC	400	110	1	10020289
UR PNK 11 50 TC	500	110	1	10020290
UR PNK 11 60 TC	600	110	1	10020291

PL Pocinkovani lim / Galvanized sheet **TC** Toplo pocinkovano potapanjem / Hot - dip galvanized



Perforirani nosači kablova

Krivina 45° / Bend 45°

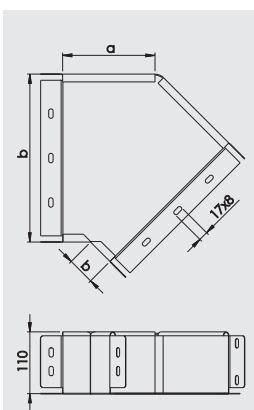

Tip Typ	Širina Width	Visina Height	Debljina Thickness	Šifra artikla Article
	mm	mm	mm	
PL				
K45 PNK 11 10 PL	100	110	1	10030266
K45 PNK 11 16 PL	160	110	1	10030267
K45 PNK 11 20 PL	200	110	1	10030268
K45 PNK 11 30 PL	300	110	1	10030269
K45 PNK 11 40 PL	400	110	1	10030270
K45 PNK 11 50 PL	500	110	1	10030271
K45 PNK 11 60 PL	600	110	1	10030272
TC				
K45 PNK 11 10 TC	100	110	1	10020292
K45 PNK 11 16 TC	160	110	1	10020293
K45 PNK 11 20 TC	200	110	1	10020294
K45 PNK 11 30 TC	300	110	1	10020295
K45 PNK 11 40 TC	400	110	1	10020296
K45 PNK 11 50 TC	500	110	1	10020297
K45 PNK 11 60 TC	600	110	1	10020298

PL Pocinkovani lim / Galvanized sheet **TC** Toplo pocinkovano potapanjem / Hot - dip galvanized



Krivina 90° / Bend 90°

H110

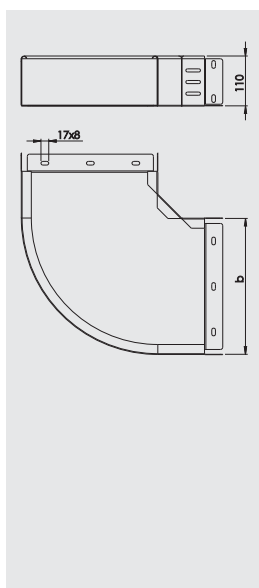

Tip Typ	Širina Width	Visina Height	Debljina Thickness	Šifra artikla Article
	mm	mm	mm	PL
L PNK 11 10 PL	100	110	1	10030273
L PNK 11 16 PL	160	110	1	10030274
L PNK 11 20 PL	200	110	1	10030275
L PNK 11 30 PL	300	110	1	10030276
L PNK 11 40 PL	400	110	1	10030277
L PNK 11 50 PL	500	110	1	10030278
L PNK 11 60 PL	600	110	1	10030279
				TC
L PNK 11 10 TC	100	110	1	10020299
L PNK 11 16 TC	160	110	1	10020300
L PNK 11 20 TC	200	110	1	10020301
L PNK 11 30 TC	300	110	1	10020302
L PNK 11 40 TC	400	110	1	10020303
L PNK 11 50 TC	500	110	1	10020304
L PNK 11 60 TC	600	110	1	10020305

PL Pocinkovani lim / Galvanized sheet **TC** Toplo pocinkovano potapanjem / Hot - dip galvanized



Ugaona spojnica / Corner connector

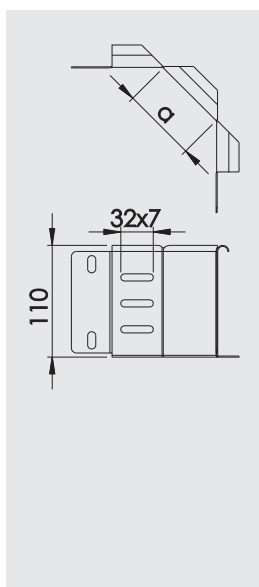

Tip Typ	Širina Width	Visina Height	Debljina Thickness	Šifra artikla Article
	mm	mm	mm	PL
US PNK 11 10 PL	100	110	1	10030280
US PNK 11 16 PL	160	110	1	10030281
US PNK 11 20 PL	200	110	1	10030282
US PNK 11 30 PL	300	110	1	10030283
US PNK 11 40 PL	400	110	1	10030284
US PNK 11 50 PL	500	110	1	10030285
US PNK 11 60 PL	600	110	1	10030286
				TC
US PNK 11 10 TC	100	110	1	10020306
US PNK 11 16 TC	160	110	1	10020307
US PNK 11 20 TC	200	110	1	10020308
US PNK 11 30 TC	300	110	1	10020309
US PNK 11 40 TC	400	110	1	10020310
US PNK 11 50 TC	500	110	1	10020311
US PNK 11 60 TC	600	110	1	10020312

PL Pocinkovani lim / Galvanized sheet **TC** Toplo pocinkovano potapanjem / Hot - dip galvanized

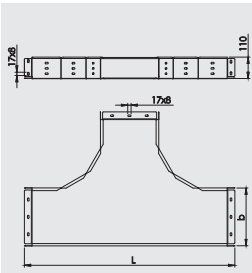

T račva / T Module

H110

Tip Typ	Širina Width	Visina Height	Debljina Thickness	Šifra artikla Article
	mm	mm	mm	
T PNK 11 10 PL	100	110	1	10030287
T PNK 11 16 PL	160	110	1	10030288
T PNK 11 20 PL	200	110	1	10030289
T PNK 11 30 PL	300	110	1	10030290
T PNK 11 40 PL	400	110	1	10030291
T PNK 11 50 PL	500	110	1	10030292
T PNK 11 60 PL	600	110	1	10030293
				TC
T PNK 11 10 TC	100	110	1	10020313
T PNK 11 16 TC	160	110	1	10020314
T PNK 11 20 TC	200	110	1	10020315
T PNK 11 30 TC	300	110	1	10020316
T PNK 11 40 TC	400	110	1	10020317
T PNK 11 50 TC	500	110	1	10020318
T PNK 11 60 TC	600	110	1	10020319

PL Pocinkovani lim / Galvanized sheet
 TC Toplo pocinkovano potapanjem / Hot - dip galvanized



Perforirani nosači kablova

Račva plus / + Connection module

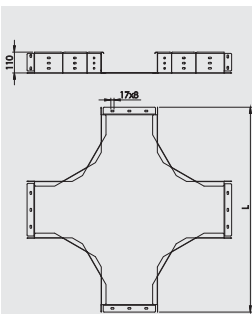

Tip Typ	Širina Width	Visina Height	Debljina Thickness	Šifra artikla Article
	mm	mm	mm	
X PNK 11 10 PL	100	110	1	10030294
X PNK 11 16 PL	160	110	1	10030295
X PNK 11 20 PL	200	110	1	10030296
X PNK 11 30 PL	300	110	1	10030297
X PNK 11 40 PL	400	110	1	10030298
X PNK 11 50 PL	500	110	1	10030299
X PNK 11 60 PL	600	110	1	10030300
				TC
X PNK 11 10 TC	100	110	1	10020320
X PNK 11 16 TC	160	110	1	10020321
X PNK 11 20 TC	200	110	1	10020322
X PNK 11 30 TC	300	110	1	10020323
X PNK 11 40 TC	400	110	1	10020324
X PNK 11 50 TC	500	110	1	10020325
X PNK 11 60 TC	600	110	1	10020326

PL Pocinkovani lim / Galvanized sheet
 TC Toplo pocinkovano potapanjem / Hot - dip galvanized



Elementi zglobno vertikalne krivine / Adjustable vertical bend element

H110

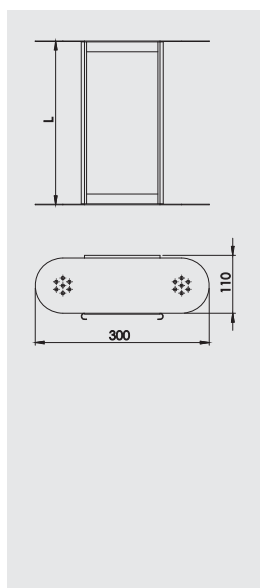

Tip Typ	Širina Width	Visina Height	Debljina Thickness	Šifra artikla Article
	mm	mm	mm	
EZK PNK 11 10 PL	100	110	1	10030301
EZK PNK 11 16 PL	160	110	1	10030302
EZK PNK 11 20 PL	200	110	1	10030303
EZK PNK 11 30 PL	300	110	1	10030304
EZK PNK 11 40 PL	400	110	1	10030305
EZK PNK 11 50 PL	500	110	1	10030306
EZK PNK 11 60 PL	600	110	1	10030307
				TC
EZK PNK 11 10 TC	100	110	1	10020327
EZK PNK 11 16 TC	160	110	1	10020328
EZK PNK 11 20 TC	200	110	1	10020329
EZK PNK 11 30 TC	300	110	1	10020330
EZK PNK 11 40 TC	400	110	1	10020331
EZK PNK 11 50 TC	500	110	1	10020332
EZK PNK 11 60 TC	600	110	1	10020333

PL Pocinkovani lim / Galvanized sheet

TC Toplo pocinkovano potapanjem / Hot - dip galvanized



Zglobno vertikalna krivina / Adjustable vertical bend

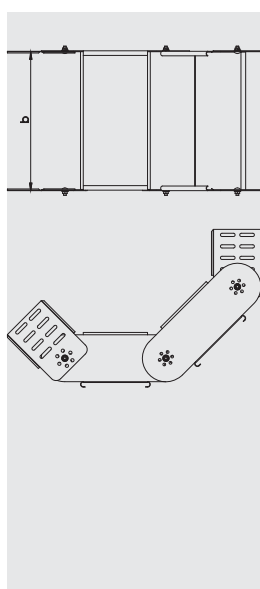

Tip Typ	Širina Width	Visina Height	Debljina Thickness	Šifra artikla Article
	mm	mm	mm	
ZK PNK 11 10 PL	100	110	1	10030308
ZK PNK 11 16 PL	160	110	1	10030309
ZK PNK 11 20 PL	200	110	1	10030310
ZK PNK 11 30 PL	300	110	1	10030311
ZK PNK 11 40 PL	400	110	1	10030312
ZK PNK 11 50 PL	500	110	1	10030313
ZK PNK 11 60 PL	600	110	1	10030314
				TC
ZK PNK 11 10 TC	100	110	1	10020334
ZK PNK 11 16 TC	160	110	1	10020335
ZK PNK 11 20 TC	200	110	1	10020336
ZK PNK 11 30 TC	300	110	1	10020337
ZK PNK 11 40 TC	400	110	1	10020338
ZK PNK 11 50 TC	500	110	1	10020339
ZK PNK 11 60 TC	600	110	1	10020340

PL Pocinkovani lim / Galvanized sheet

TC Toplo pocinkovano potapanjem / Hot - dip galvanized

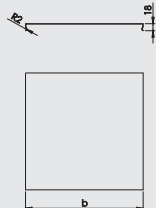

Klik poklopac 2000mm / Click cover 2000mm
POK

Tip Typ	Širina Width	Debljina Thickness	Dužina Length	Šifra artikla Article
	mm	mm	mm	PL
KPC PNK 50/2000 PL	50	0.75	2000	080010000
KPC PNK 100/2000 PL	100	0.75	2000	080010001
KPC PNK 160/2000 PL	160	0.75	2000	080010002
KPC PNK 200/2000 PL	200	0.75	2000	080010003
KPC PNK 300/2000 PL	300	0.75	2000	080010004
KPC PNK 400/2000 PL	400	1	2000	080010005
KPC PNK 500/2000 PL	500	1	2000	080010006
KPC PNK 600/2000 PL	600	1	2000	080010007

PL Pocinkovani lim / Galvanized sheet

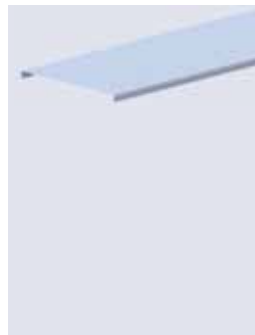

Perforirani nosači kablova

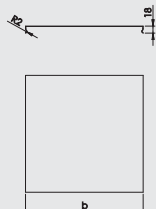
Klik poklopac 3000mm / Click cover 3000mm

Tip Typ	Širina Width	Debljina Thickness	Dužina Length	Šifra artikla Article
	mm	mm	mm	PL
KPC PNK 50/3000 PL	50	0.75	3000	080010008
KPC PNK 100/3000 PL	100	0.75	3000	080010009
KPC PNK 160/3000 PL	160	0.75	3000	080010010
KPC PNK 200/3000 PL	200	0.75	3000	080010011
KPC PNK 300/3000 PL	300	0.75	3000	080010012
KPC PNK 400/3000 PL	400	1	3000	080010013
KPC PNK 500/3000 PL	500	1	3000	080010014
KPC PNK 600/3000 PL	600	1	3000	080010015

PL Pocinkovani lim / Galvanized sheet

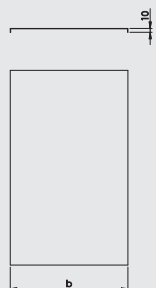
Poklopac regala 2000mm / Cable tray cover 2000mm

Tip Typ	Širina Width	Debljina Thickness	Dužina Length	Šifra artikla Article
	mm	mm	mm	PL
PC PNK 50/2000 PL	50	0.75	2000	080010016
PC PNK 100/2000 PL	100	0.75	2000	080010017
PC PNK 160/2000 PL	160	0.75	2000	080010018
PC PNK 200/2000 PL	200	0.75	2000	080010019
PC PNK 300/2000 PL	300	0.75	2000	080010020
PC PNK 400/2000 PL	400	1	2000	080010021
PC PNK 500/2000 PL	500	1	2000	080010022
PC PNK 600/2000 PL	600	1	2000	080010023
				TC
PC PNK 50/2000 TC	50	1	2000	080020001
PC PNK 100/2000 TC	100	1	2000	080020002
PC PNK 160/2000 TC	160	1	2000	080020003
PC PNK 200/2000 TC	200	1	2000	080020004
PC PNK 300/2000 TC	300	1	2000	080020005
PC PNK 400/2000 TC	400	1	2000	080020006
PC PNK 500/2000 TC	500	1	2000	080020007
PC PNK 600/2000 TC	600	1	2000	080020008

PL Pocinkovani lim / Galvanized sheet

TC Toplo pocinkovano potapanjem / Hot-dip galvanized

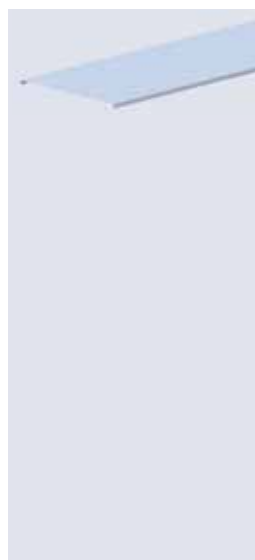

Poklopac regala 3000mm / Cable tray cover 3000mm

POK

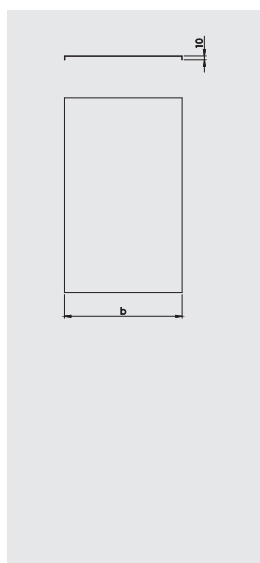

Tip Typ	Širina Width	Debljina Thickness	Dužina Length	Šifra artikla Article
	mm	mm	mm	PL
PC PNK 50/3000 PL	50	0.75	3000	080010024
PC PNK 100/3000 PL	100	0.75	3000	080010025
PC PNK 160/3000 PL	160	0.75	3000	080010026
PC PNK 200/3000 PL	200	0.75	3000	080010027
PC PNK 300/3000 PL	300	0.75	3000	080010028
PC PNK 400/3000 PL	400	1	3000	080010029
PC PNK 500/3000 PL	500	1	3000	080010030
PC PNK 600/3000 PL	600	1	3000	080010031
				TC
PC PNK 50/3000 TC	50	1	3000	080020009
PC PNK 100/3000 TC	100	1	3000	080020010
PC PNK 160/3000 TC	160	1	3000	080020011
PC PNK 200/3000 TC	200	1	3000	080020012
PC PNK 300/3000 TC	300	1	3000	080020013
PC PNK 400/3000 TC	400	1	3000	080020014
PC PNK 500/3000 TC	500	1	3000	080020015
PC PNK 600/3000 TC	600	1	3000	080020016

PL Pocinkovani lim / Galvanized sheet

TC Toplo pocinkovano potapanjem / Hot - dip galvanized

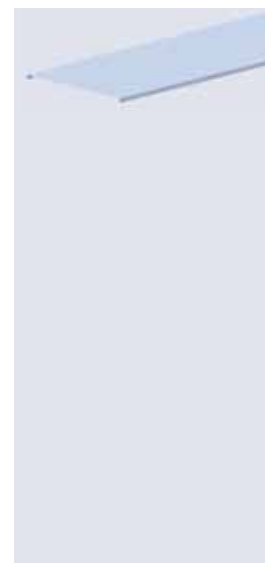

Poklopac L krivine / 90° Bend cover

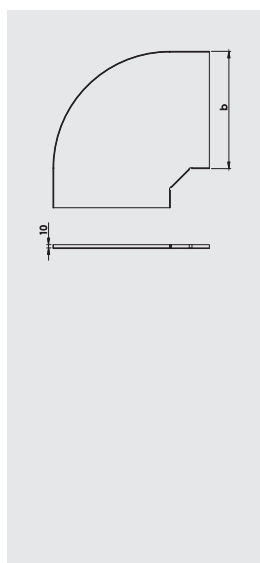

Tip Typ	Širina Width	Šifra artikla Article
	mm	PL
PL PNK 50 PL	50	080010032
PL PNK 100 PL	100	080010033
PL PNK 160 PL	160	080010034
PL PNK 200 PL	200	080010035
PL PNK 300 PL	300	080010036
PL PNK 400 PL	400	080010037
PL PNK 500 PL	500	080010038
PL PNK 600 PL	600	080010039
		TC
PL PNK 50 TC	50	080020017
PL PNK 100 TC	100	080020018
PL PNK 160 TC	160	080020019
PL PNK 200 TC	200	080020020
PL PNK 300 TC	300	080020021
PL PNK 400 TC	400	080020022
PL PNK 500 TC	500	080020023
PL PNK 600 TC	600	080020024

PL Pocinkovani lim / Galvanized sheet

TC Toplo pocinkovano potapanjem / Hot - dip galvanized

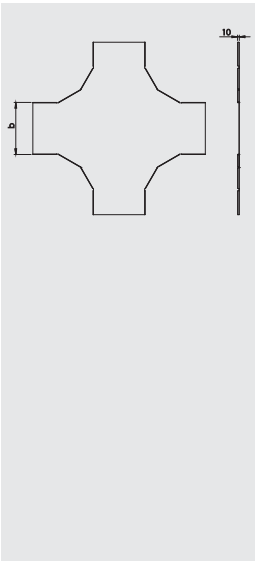

Poklopac racve plus / Cover + Connection module
POK

Tip Typ	Širina Width	Šifra artikla Article
	mm	PL
PR PNK 50 PL	50	080010040
PR PNK 100 PL	100	080010041
PR PNK 160 PL	160	080010042
PR PNK 200 PL	200	080010043
PR PNK 300 PL	300	080010044
PR PNK 400 PL	400	080010045
PR PNK 500 PL	500	080010046
PR PNK 600 PL	600	080010047
		TC
PR PNK 50 TC	50	080020025
PR PNK 100 TC	100	080020026
PR PNK 160 TC	160	080020027
PR PNK 200 TC	200	080020028
PR PNK 300 TC	300	080020029
PR PNK 400 TC	400	080020030
PR PNK 500 TC	500	080020031
PR PNK 600 TC	600	080020032



Perforirani nosači kablova

PL Pocinkovani lim / Galvanized sheet
 TC Toplo pocinkovano potapanjem / Hot - dip galvanized

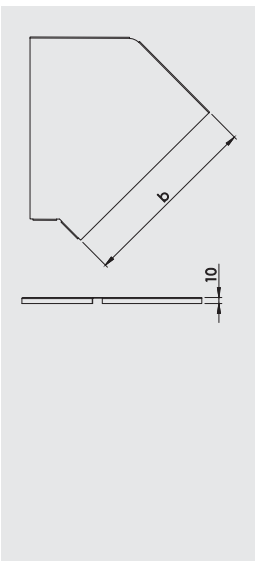
Poklopac krivine 45° / 45° Bend cover

Tip Typ	Širina Width	Šifra artikla Article
	mm	PL
PK PNK 50 PL	50	080010048
PK PNK 100 PL	100	080010049
PK PNK 160 PL	160	080010050
PK PNK 200 PL	200	080010051
PK PNK 300 PL	300	080010052
PK PNK 400 PL	400	080010053
PK PNK 500 PL	500	080010054
PK PNK 600 PL	600	080010055
		TC
PK PNK 50 TC	50	080020033
PK PNK 100 TC	100	080020034
PK PNK 160 TC	160	080020035
PK PNK 200 TC	200	080020036
PK PNK 300 TC	300	080020037
PK PNK 400 TC	400	080020038
PK PNK 500 TC	500	080020039
PK PNK 600 TC	600	080020040

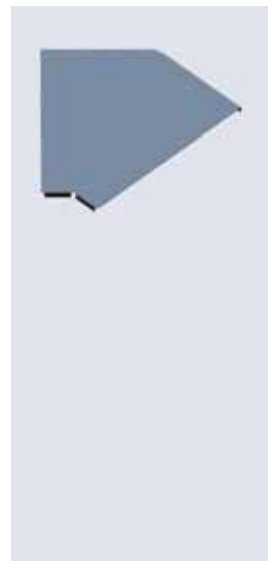

PL Pocinkovani lim / Galvanized sheet
 TC Toplo pocinkovano potapanjem / Hot - dip galvanized

Poklopac T račve/ Cover T Module

POK

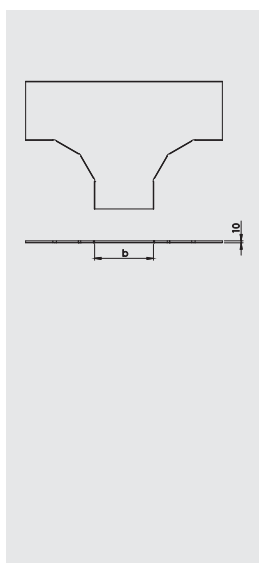

Tip Typ	Širina Width	Šifra artikla Article
	mm	PL
PT PNK 50 PL	50	080010056
PT PNK 100 PL	100	080010057
PT PNK 160 PL	160	080010058
PT PNK 200 PL	200	080010059
PT PNK 300 PL	300	080010060
PT PNK 400 PL	400	080010061
PT PNK 500 PL	500	080010062
PT PNK 600 PL	600	080010063
		TC
PT PNK 50 TC	50	080020041
PT PNK 100 TC	100	080020042
PT PNK 160 TC	160	080020043
PT PNK 200 TC	200	080020044
PT PNK 300 TC	300	080020045
PT PNK 400 TC	400	080020046
PT PNK 500 TC	500	080020047
PT PNK 600 TC	600	080020048

PL Pocinkovani lim / Galvanized sheet

TC Toplo pocinkovano potapanjem / Hot - dip galvanized

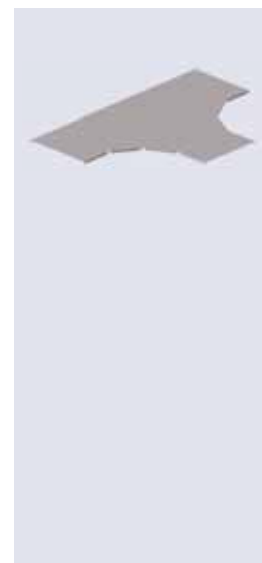

Poklopac vertikalne krivine na dole / Cover for the down vertical curve

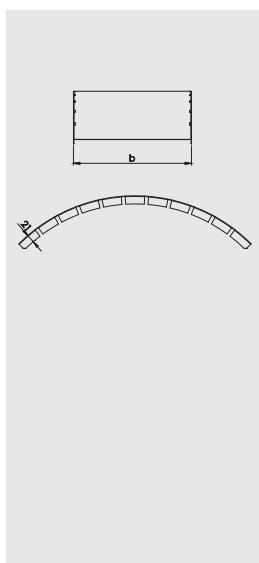

Tip Typ	Širina Width	Šifra artikla Article
	mm	PL
PD PNK 50 PL	50	080010064
PD PNK 100 PL	100	080010065
PD PNK 160 PL	160	080010066
PD PNK 200 PL	200	080010067
PD PNK 300 PL	300	080010068
PD PNK 400 PL	400	080010069
PD PNK 500 PL	500	080010070
PD PNK 600 PL	600	080010071
		TC
PD PNK 50 TC	50	080020049
PD PNK 100 TC	100	080020050
PD PNK 160 TC	160	080020051
PD PNK 200 TC	200	080020052
PD PNK 300 TC	300	080020053
PD PNK 400 TC	400	080020054
PD PNK 500 TC	500	080020055
PD PNK 600 TC	600	080020056

PL Pocinkovani lim / Galvanized sheet

TC Toplo pocinkovano potapanjem / Hot - dip galvanized

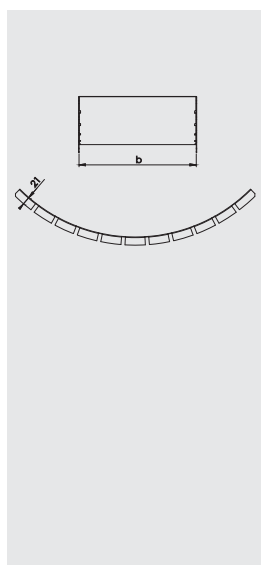

Poklopac vertikalne krivine na gore / Cover for the mounting vertical curve

POK

Tip Typ	Širina Width	Šifra artikla Article
	mm	PL
PG PNK 50 PL	50	80010072
PG PNK 100 PL	100	80010073
PG PNK 160 PL	160	80010074
PG PNK 200 PL	200	80010075
PG PNK 300 PL	300	80010076
PG PNK 400 PL	400	80010077
PG PNK 500 PL	500	80010078
PG PNK 600 PL	600	80010079
		TC
PG PNK 50 TC	50	80020057
PG PNK 100 TC	100	80020058
PG PNK 160 TC	160	80020059
PG PNK 200 TC	200	80020060
PG PNK 300 TC	300	80020061
PG PNK 400 TC	400	80020062
PG PNK 500 TC	500	80020063
PG PNK 600 TC	600	80020064

PL Pocinkovani lim / Galvanized sheet

TC Toplo pocinkovano potapanjem / Hot - dip galvanized

Perforirani nosači kablova

H50

H60

H110



LNK

3

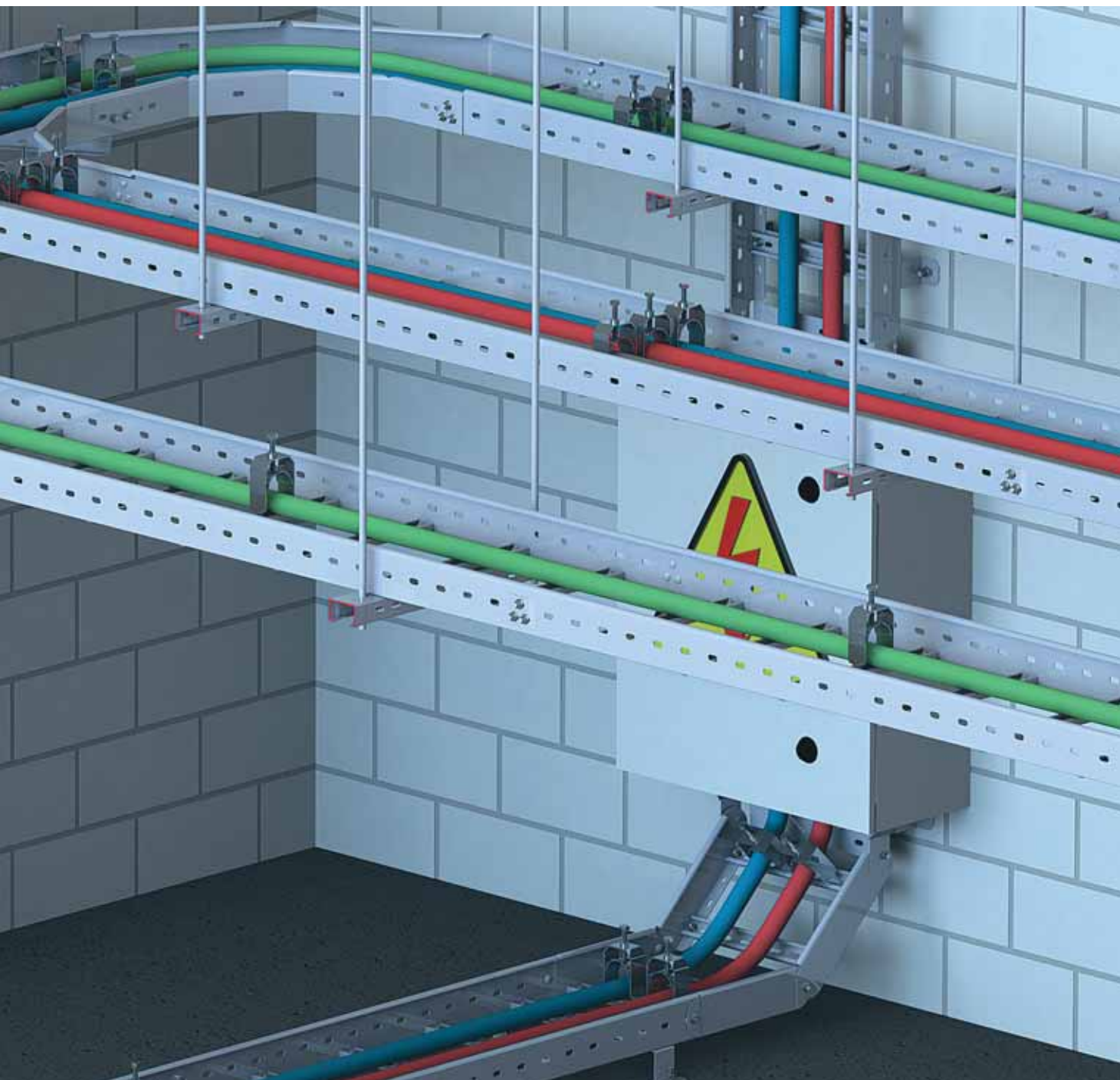

LESTVIČASTI NOSAČI KABLOVA

LADDER CABLE TRAY SYSTEMS

Montažni sistemi

Perforirani nosači kablova

Lestvičasti nosači kablova

Mrežasti nosači kablova

E90 - Vatrootporni nosači

Nosači kablova za rasvetu

Nosači kablova od Inox-a

Plastificirani nosači kablova

Prčirski sistemi



1

Montaža regala na odstojnik vrši se pomoću torban vijaka tipa PEKOM M6 x 12.

We use PEKOM torch bolt, type M6x12 for mounting the cable tray against the spacer.



2

Spoj regala podno-rotirajućom spojnicom za premošćavanje visinske razlike.

Joint of the cable trays with floor-rotating coupling for bridging the height difference.



3

Montaža + račve i regala nosača kablova ostvarena je direktnom vezom pomoću torban vijaka tipa PEKOM M6 x 12.

Installation of the cross-section twitch and cable tray carrier was achieved by direct connection with the PEKOM torch bolt, type M6 x 12.



4

Pričvršćivanje UD nosača na kosi betonski plafon pomoću anker vijaka tipa PEKOM FAZ II.

Fastening the UD carrier to the concrete ceiling under the slope with PEKOM anchor bolts, type FAZ II.



5

Montaža T račve i nosača kablova ostvarena je pomoću torban vijaka tipa PEKOM M6 x 12.

Installation of the T twitch and the cable tray was achieved using the PEKOM M6 x 12 torch screw.



6

Princip montaže lestvičastog regala na zid pomoću odstojnika vrši se pomoću torban vijaka tipa PEKOM M6 x 12.

The principle of mounting ladder cable tray to the wall by spacer is done by PEKOM M6 x 12 torch screw.



7

Pričvršćivanje nosača kablova za konzolu vrši se torban vijcima PEKOM M6 x 12 i nazubljenim maticama M6.

Attachment of the cable trays to the console is carried out with torch bolts PEKOM M6 x 12 and knotted nut M6.



8

Princip izrade plafonske podkonstrukcije pomoću U profila U5 tipa PEKOM.

The principle of the construction of the ceiling substructure with the U profile PEKOM U5-type.



9

Montaža krivine 90° i nosača kablova ostvaruje se putem vijaka tipa PEKOM M6 x 12.

The installation of the 90° curve and the cable tray is achieved through the PEKOM M6 x 12 type screws.



10

Za montažu lestvičastog regala na plafon pomoću dve navojne šipke, koristi se profilna perforirana šina za dve navojne šipke.

We use a profiled perforated rail with two threaded rods, for mounting ladder cable tray against the ceiling by two threaded rods.

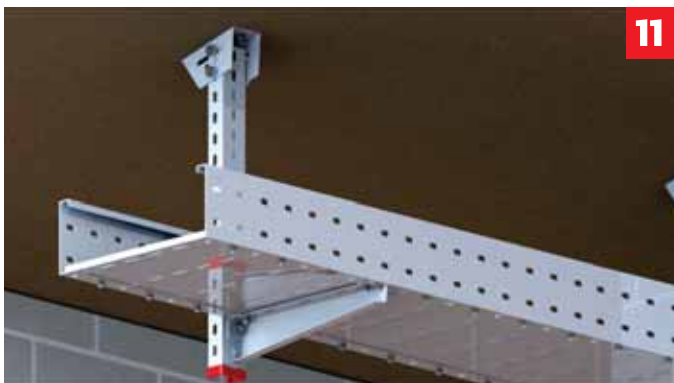

11

Plafonska montaža regala vrši se pomoću UD nosača, U profila i konzola.

We use UD carrier, U profile and cantilever for the mounting the cable tray to the ceiling.

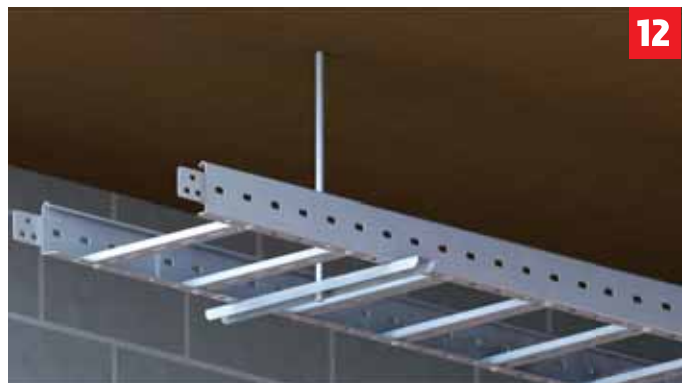

12

Prikaz montaže lestvičastog nosača kablova na jednu navojnu šipku pomoću perforirane profilne šine.

Display of the mounting ladder cable tray on a threaded rod by perforated profile ray.



13

Pričvršćivanje nosača kablova za konzolu vrši se torban vijcima PEKOM M6 x 12.

Attachment of the cable tray to the cantilever is done by PEKOM M6 x 12 torch screw.



14

Princip montaže lestvičastog regala po podu na odstoyniku sa poklopcem.

The principle of the mounting ladder cable tray with lid to the spacer on the floor.



15

Zglobna spojnica koristi se kod premošćavanja razlike u visinama. Zglobna spojnica se može fiksirati pod određenim uglovima.

Angle connector is used for bridging the difference in heights. Angle connector can be fixed at the certain angles.

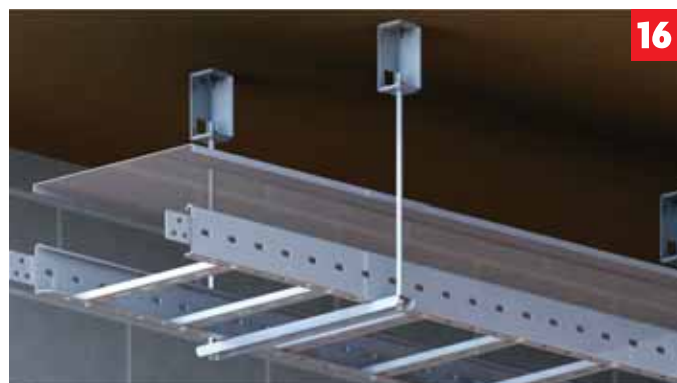

16

Princip montaže poklopcu na lestvičasti regal.

The principle of mounting the lid on a ladder cable tray.



17

Zglobna krivina za premošćavanje razlike u visinama.

Angle curve for bridging the difference in heights.



18

Princip montaže lestvičastog regala na zid sa poklopcem.

The principle of the mounting ladder cable tray with lid to the wall.

Nosač kablova LNK / Ladder cable trays

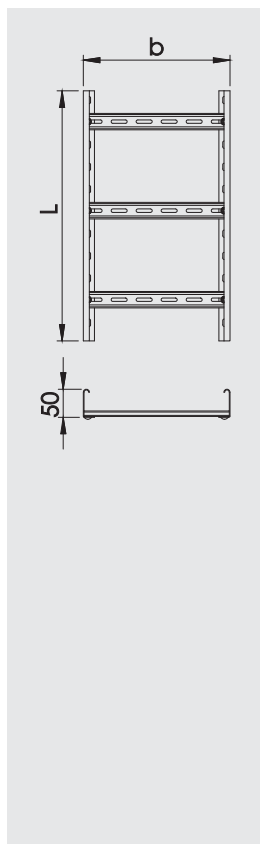
H50

Tip Typ	Širina Width	Visina Height	Debljina Thickness	Dužina Length	Dozvoljeno opterećenje Allowed load			Šifra artikla Article
					1.5 m	2.0 m	2.5 m	
	mm	mm	mm	mm	kg/m			PL
LNK 5 10 300 PL	100	50	1.5	3000	240	190	140	20010001
LNK 5 20 300 PL	200	50	1.5	3000	210	160	130	20010003
LNK 5 30 300 PL	300	50	1.5	3000	208	170	135	20010006
LNK 5 40 300 PL	400	50	1.5	3000	190	148	112	20010009
LNK 5 50 300 PL	500	50	1.5	3000	197	150	120	20010012
LNK 5 60 300 PL	600	50	1.5	3000	210	160	120	20010015
								TC
LNK 5 10 300 TC	100	50	1.5	3000	240	190	140	20020001
LNK 5 20 300 TC	200	50	1.5	3000	210	160	130	20020002
LNK 5 30 300 TC	300	50	1.5	3000	208	170	135	20020003
LNK 5 40 300 TC	400	50	1.5	3000	190	148	112	20020004
LNK 5 50 300 TC	500	50	1.5	3000	197	150	120	20020005
LNK 5 60 300 TC	600	50	1.5	3000	210	160	120	20020006

PL Pocinkovani lim / Galvanized sheet
 TC Toplo pocinkovano potapanjem / Hot - dip galvanized

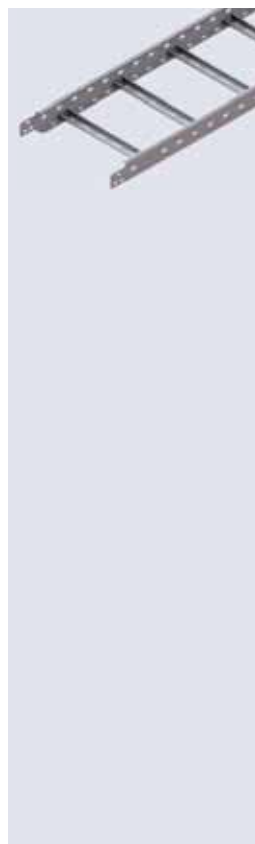
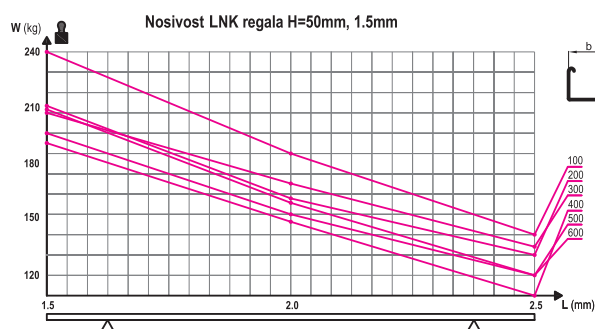

Lestvica nosači kablova

Nosač kablova VLNK / VLNK cable trays

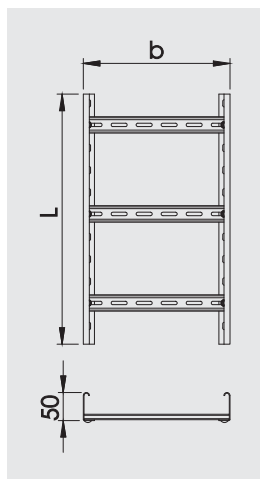

Tip Typ	Širina Width	Visina Height	Debljina Thickness	Dužina Length	Dozvoljeno opterećenje Allowed load			Šifra artikla Article
					1.5 m	2.0 m	2.5 m	
	mm	mm	mm	mm	kg/m			PL
VLNK 5 10 300 PL	100	50	2	3000	240	190	140	20040001
VLNK 5 20 300 PL	200	50	2	3000	210	160	130	20040002
VLNK 5 30 300 PL	300	50	2	3000	208	170	135	20040003
VLNK 5 40 300 PL	400	50	2	3000	190	148	112	20040004
VLNK 5 50 300 PL	500	50	2	3000	197	150	120	20040005
VLNK 5 60 300 PL	600	50	2	3000	210	160	120	20040006
								TC
VLNK 5 10 300 TC	100	50	2	3000	240	190	140	20020007
VLNK 5 20 300 TC	200	50	2	3000	210	160	130	20020008
VLNK 5 30 300 TC	300	50	2	3000	208	170	135	20020009
VLNK 5 40 300 TC	400	50	2	3000	190	148	112	20020010
VLNK 5 50 300 TC	500	50	2	3000	197	150	120	20020011
VLNK 5 60 300 TC	600	50	2	3000	210	160	120	20020012

PL Pocinkovani lim / Galvanized sheet
 TC Toplo pocinkovano potapanjem / Hot - dip galvanized



Bočna spojnica / Straight connector

H50

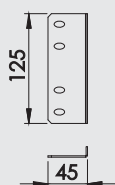

Tip Typ	Širina Width	Visina Height	Debljina Thickness	Šifra artikla Article
S LNK 50 PL	100	50	1.5	PL 20030000
S LNK 50 TC	100	50	1.5	TC 20020013

PL Pocinkovani lim / Galvanized sheet **TC** Toplo pocinkovano potapanjem / Hot - dip galvanized



Bočna spojnica VLNK / VLNK Straight connector

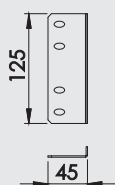

Tip Typ	Širina Width	Visina Height	Debljina Thickness	Šifra artikla Article
S VLNK 50 PL	100	50	2	PL 20030001
S VLNK 50 TC	100	50	2	TC 20020014

PL Pocinkovani lim / Galvanized sheet **TC** Toplo pocinkovano potapanjem / Hot - dip galvanized



Pregrada / Divider

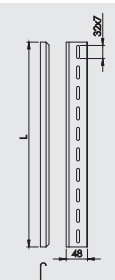

Tip Typ	Visina Height	Dužina Length	Pakovanje Pack kom piece	Šifra artikla Article
P PNK 50 PL	50	3000	10	PL 10030046
P PNK 50 TC	50	3000	10	TC 10020022

PL Pocinkovani lim / Galvanized sheet **TC** Toplo pocinkovano potapanjem / Hot - dip galvanized

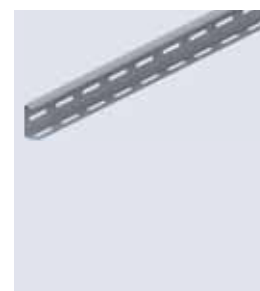

Lomljiva spojnica / Angle connector

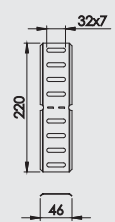

Tip Typ	Visina Height	Pakovanje Pack kom piece	Šifra artikla Article
LS PNK 50 PL	50	50	PL 10030048
LS PNK 50 TC	50	50	TC 10020024

PL Pocinkovani lim / Galvanized sheet **TC** Toplo pocinkovano potapanjem / Hot - dip galvanized



Zglobna spojnica / Adjustable connector

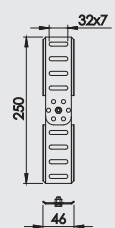

Tip Typ	Visina Height	Pakovanje Pack kom piece	Šifra artikla Article
ZS PNK 50 PL	50	50	PL 10030049
ZS PNK 50 TC	50	50	TC 10020025

PL Pocinkovani lim / Galvanized sheet **TC** Toplo pocinkovano potapanjem / Hot - dip galvanized

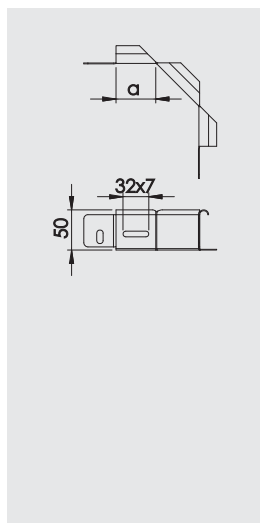

Ugaona spojnica / Corner connector

H50

Tip Typ	Širina Width	Visina Height	Debljina Thickness	Šifra artikla Article
	mm	mm	mm	
US PNK 5 5 PL	50	50	1	10030074
US PNK 5 10 PL	100	50	1	10030075
US PNK 5 20 PL	200	50	1	10030077
US PNK 5 30 PL	300	50	1	10030078
US PNK 5 40 PL	400	50	1	10030079
US PNK 5 50 PL	500	50	1	10030080
US PNK 5 60 PL	600	50	1	10030081
				TC
US PNK 5 5 TC	50	50	1	10020050
US PNK 5 10 TC	100	50	1	10020051
US PNK 5 20 TC	200	50	1	10020053
US PNK 5 30 TC	300	50	1	10020054
US PNK 5 40 TC	400	50	1	10020055
US PNK 5 50 TC	500	50	1	10020056
US PNK 5 60 TC	600	50	1	10020057

PL Pocinkovani lim / Galvanized sheet

TC Toplo pocinkovano potapanjem / Hot - dip galvanized

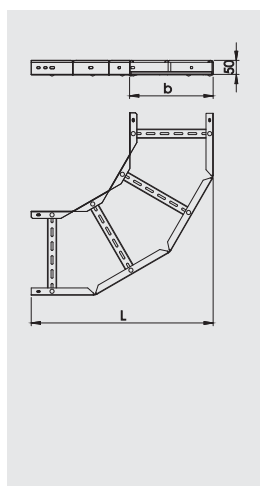

Lestvičasti nosači kablova

Krivina 90° / Bend 90°

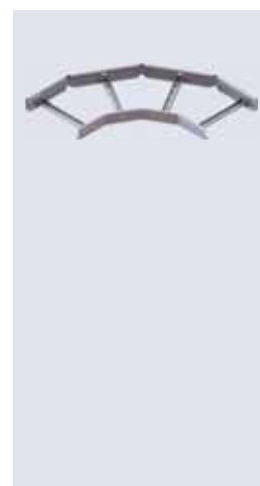

Tip Typ	Širina Width	Visina Height	Debljina Thickness	Šifra artikla Article
	mm	mm	mm	
L LNK 5 10 PL	100	50	1.5	20030002
L LNK 5 20 PL	200	50	1.5	20030003
L LNK 5 30 PL	300	50	1.5	20030004
L LNK 5 40 PL	400	50	1.5	20030005
L LNK 5 50 PL	500	50	1.5	20030006
L LNK 5 60 PL	600	50	1.5	20030007
				TC
L LNK 5 10 TC	100	50	1.5	20020015
L LNK 5 20 TC	200	50	1.5	20020016
L LNK 5 30 TC	300	50	1.5	20020017
L LNK 5 40 TC	400	50	1.5	20020018
L LNK 5 50 TC	500	50	1.5	20020019
L LNK 5 60 TC	600	50	1.5	20020020

PL Pocinkovani lim / Galvanized sheet

TC Toplo pocinkovano potapanjem / Hot - dip galvanized

Krivina 90° VLNK / VLNK Bend 90°

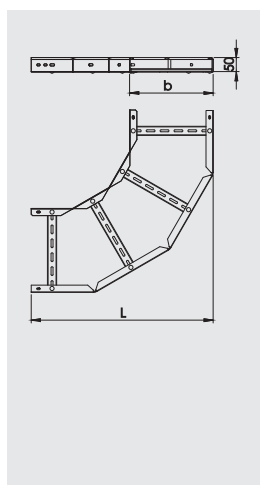

Tip Typ	Širina Width	Visina Height	Debljina Thickness	Šifra artikla Article
	mm	mm	mm	
L VLNK 5 10 PL	100	50	2	20030008
L VLNK 5 20 PL	200	50	2	20030009
L VLNK 5 30 PL	300	50	2	20030010
L VLNK 5 40 PL	400	50	2	20030011
L VLNK 5 50 PL	500	50	2	20030012
L VLNK 5 60 PL	600	50	2	20030013
				TC
L VLNK 5 10 TC	100	50	2	20020021
L VLNK 5 20 TC	200	50	2	20020022
L VLNK 5 30 TC	300	50	2	20020023
L VLNK 5 40 TC	400	50	2	20020024
L VLNK 5 50 TC	500	50	2	20020025
L VLNK 5 60 TC	600	50	2	20020026

PL Pocinkovani lim / Galvanized sheet

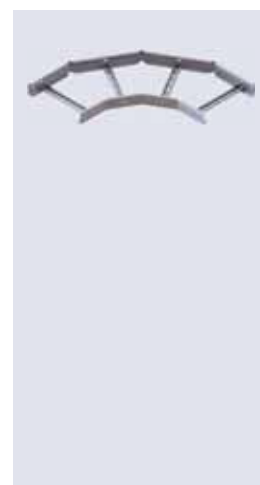
TC Toplo pocinkovano potapanjem / Hot - dip galvanized

T račva / T Module

H50

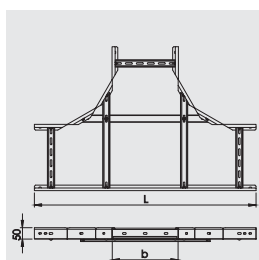

Tip Typ	Širina Width	Visina Height	Debljina Thickness	Šifra artikla Article
	mm	mm	mm	PL
T LNK 5 10 PL	100	50	1.5	20030014
T LNK 5 20 PL	200	50	1.5	20030015
T LNK 5 30 PL	300	50	1.5	20030016
T LNK 5 40 PL	400	50	1.5	20030017
T LNK 5 50 PL	500	50	1.5	20030018
T LNK 5 60 PL	600	50	1.5	20030019
				TC
T LNK 5 10 TC	100	50	1.5	20020027
T LNK 5 20 TC	200	50	1.5	20020028
T LNK 5 30 TC	300	50	1.5	20020029
T LNK 5 40 TC	400	50	1.5	20020030
T LNK 5 50 TC	500	50	1.5	20020031
T LNK 5 60 TC	600	50	1.5	20020032

PL Pocinkovani lim / Galvanized sheet

TC Toplo pocinkovano potapanjem / Hot - dip galvanized



T račva VLNK / VLNK T Module

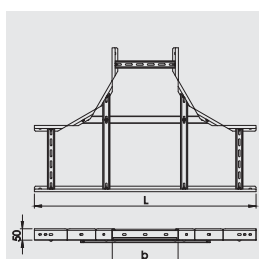

Tip Typ	Širina Width	Visina Height	Debljina Thickness	Šifra artikla Article
	mm	mm	mm	PL
T VLNK 5 10 PL	100	50	2	20030020
T VLNK 5 20 PL	200	50	2	20030021
T VLNK 5 30 PL	300	50	2	20030022
T VLNK 5 40 PL	400	50	2	20030023
T VLNK 5 50 PL	500	50	2	20030024
T VLNK 5 60 PL	600	50	2	20030025
				TC
T VLNK 5 10 TC	100	50	2	20020033
T VLNK 5 20 TC	200	50	2	20020034
T VLNK 5 30 TC	300	50	2	20020035
T VLNK 5 40 TC	400	50	2	20020036
T VLNK 5 50 TC	500	50	2	20020037
T VLNK 5 60 TC	600	50	2	20020038

PL Pocinkovani lim / Galvanized sheet

TC Toplo pocinkovano potapanjem / Hot - dip galvanized



Račva plus / + Connection module

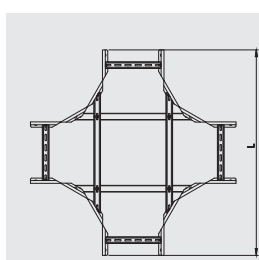

Tip Typ	Širina Width	Visina Height	Debljina Thickness	Šifra artikla Article
	mm	mm	mm	PL
X LNK 5 10 PL	100	50	1.5	20030026
X LNK 5 20 PL	200	50	1.5	20030027
X LNK 5 30 PL	300	50	1.5	20030028
X LNK 5 40 PL	400	50	1.5	20030029
X LNK 5 50 PL	500	50	1.5	20030030
X LNK 5 60 PL	600	50	1.5	20030031
				TC
X LNK 5 10 TC	100	50	1.5	20020039
X LNK 5 20 TC	200	50	1.5	20020040
X LNK 5 30 TC	300	50	1.5	20020041
X LNK 5 40 TC	400	50	1.5	20020042
X LNK 5 50 TC	500	50	1.5	20020043
X LNK 5 60 TC	600	50	1.5	20020044

PL Pocinkovani lim / Galvanized sheet

TC Toplo pocinkovano potapanjem / Hot - dip galvanized

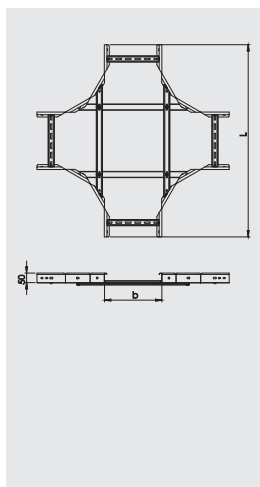

Račva plus VLNK / VLNK + Connection module

H50

Tip Typ	Širina Width	Visina Height	Debljina Thickness	Šifra artikla Article
	mm	mm	mm	PL
X VLNK 5 10 PL	100	50	2	20030032
X VLNK 5 20 PL	200	50	2	20030033
X VLNK 5 30 PL	300	50	2	20030034
X VLNK 5 40 PL	400	50	2	20030035
X VLNK 5 50 PL	500	50	2	20030036
X VLNK 5 60 PL	600	50	2	20030037
				TC
X VLNK 5 10 TC	100	50	2	20020045
X VLNK 5 20 TC	200	50	2	20020046
X VLNK 5 30 TC	300	50	2	20020047
X VLNK 5 40 TC	400	50	2	20020048
X VLNK 5 50 TC	500	50	2	20020049
X VLNK 5 60 TC	600	50	2	20020050

PL Pocinkovani lim / Galvanized sheet
 TC Toplo pocinkovano potapanjem / Hot - dip galvanized



Lestvičasti nosači kablova

Elementi zglobovno vertikalne krivine / Adjustable vertical bend element

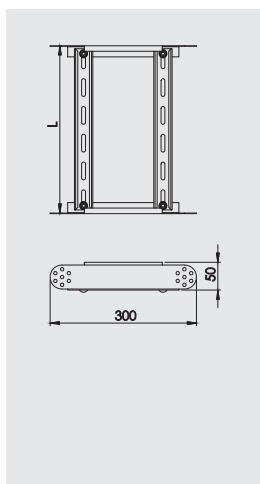

Tip Typ	Širina Width	Visina Height	Debljina Thickness	Šifra artikla Article
	mm	mm	mm	PL
EZK LNK 5 10 PL	100	50	1.5	20030038
EZK LNK 5 20 PL	200	50	1.5	20030039
EZK LNK 5 30 PL	300	50	1.5	20030040
EZK LNK 5 40 PL	400	50	1.5	20030041
EZK LNK 5 50 PL	500	50	1.5	20030042
EZK LNK 5 60 PL	600	50	1.5	20030043
				TC
EZK LNK 5 10 TC	100	50	1.5	20020051
EZK LNK 5 20 TC	200	50	1.5	20020052
EZK LNK 5 30 TC	300	50	1.5	20020053
EZK LNK 5 40 TC	400	50	1.5	20020054
EZK LNK 5 50 TC	500	50	1.5	20020055
EZK LNK 5 60 TC	600	50	1.5	20020056

PL Pocinkovani lim / Galvanized sheet
 TC Toplo pocinkovano potapanjem / Hot - dip galvanized



Elementi zglobovno vertikalne krivine VLNK / VLNK Adjustable vertical bend element

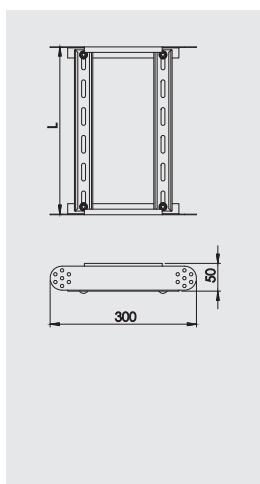

Tip Typ	Širina Width	Visina Height	Debljina Thickness	Šifra artikla Article
	mm	mm	mm	PL
EZK VLNK 5 10 PL	100	50	2	20030044
EZK VLNK 5 20 PL	200	50	2	20030045
EZK VLNK 5 30 PL	300	50	2	20030046
EZK VLNK 5 40 PL	400	50	2	20030047
EZK VLNK 5 50 PL	500	50	2	20030048
EZK VLNK 5 60 PL	600	50	2	20030049
				TC
EZK VLNK 5 10 TC	100	50	2	20020057
EZK VLNK 5 20 TC	200	50	2	20020058
EZK VLNK 5 30 TC	300	50	2	20020059
EZK VLNK 5 40 TC	400	50	2	20020060
EZK VLNK 5 50 TC	500	50	2	20020061
EZK VLNK 5 60 TC	600	50	2	20020062

PL Pocinkovani lim / Galvanized sheet
 TC Toplo pocinkovano potapanjem / Hot - dip galvanized



Zglobno vertikalna krivina / Adjustable vertical bend

H50

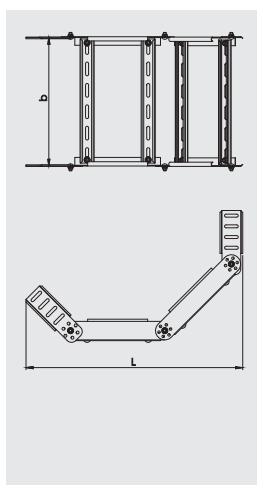

Tip Typ	Širina Width	Visina Height	Debljina Thickness	Šifra artikla Article
	mm	mm	mm	
ZK LNK 5 10 PL	100	50	1.5	20030050
ZK LNK 5 20 PL	200	50	1.5	20030051
ZK LNK 5 30 PL	300	50	1.5	20030052
ZK LNK 5 40 PL	400	50	1.5	20030053
ZK LNK 5 50 PL	500	50	1.5	20030054
ZK LNK 5 60 PL	600	50	1.5	20030055
ZK LNK 5 10 TC	100	50	1.5	20020063
ZK LNK 5 20 TC	200	50	1.5	20020064
ZK LNK 5 30 TC	300	50	1.5	20020065
ZK LNK 5 40 TC	400	50	1.5	20020066
ZK LNK 5 50 TC	500	50	1.5	20020067
ZK LNK 5 60 TC	600	50	1.5	20020068

PL Pocinkovani lim / Galvanized sheet

TC Toplo pocinkovano potapanjem / Hot - dip galvanized



Zglobno vertikalna krivina VLNK / VLNK Adjustable vertical bend

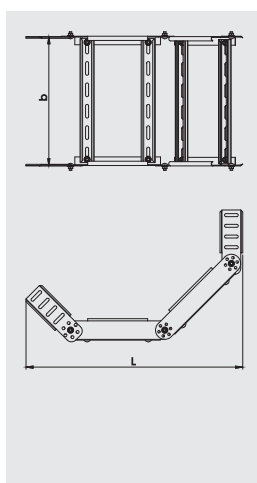

Tip Typ	Širina Width	Visina Height	Debljina Thickness	Šifra artikla Article
	mm	mm	mm	
ZK VLNK 5 10 PL	100	50	2	20030056
ZK VLNK 5 20 PL	200	50	2	20030057
ZK VLNK 5 30 PL	300	50	2	20030058
ZK VLNK 5 40 PL	400	50	2	20030059
ZK VLNK 5 50 PL	500	50	2	20030060
ZK VLNK 5 60 PL	600	50	2	20030061
ZK VLNK 5 10 TC	100	50	2	20020069
ZK VLNK 5 20 TC	200	50	2	20020070
ZK VLNK 5 30 TC	300	50	2	20020071
ZK VLNK 5 40 TC	400	50	2	20020072
ZK VLNK 5 50 TC	500	50	2	20020073
ZK VLNK 5 60 TC	600	50	2	20020074

PL Pocinkovani lim / Galvanized sheet

TC Toplo pocinkovano potapanjem / Hot - dip galvanized



Lučna obujmica LNK / LNK cable clamp

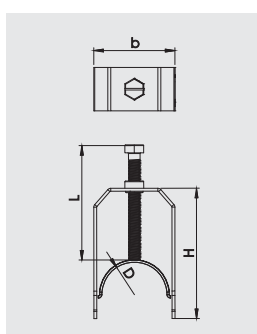

Tip Typ	Širina b Width b	Visina H Height H	Debljina Thickness	Dužina navoja L Thread length	Zatezna oblast D Clamping range D	Šifra artikla Article
	mm	mm	mm	mm	mm	
LNK obujmica 40 PL	40	50	1.5	50	30-41	20030186
LNK obujmica 56 PL	56	76	1.5	50	47-60	20030187
LNK obujmica 40 TC	40	50	1.5	50	30-41	20020223
LNK obujmica 56 TC	56	76	1.5	50	47-60	20020224

PL Pocinkovani lim / Galvanized sheet

TC Toplo pocinkovano potapanjem / Hot - dip galvanized

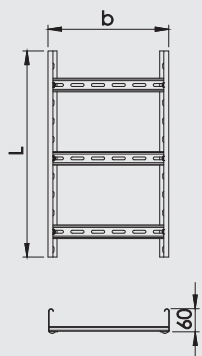

Nosač kablova LNK / Ladder cable trays

H60

Tip Typ	Širina Width	Visina Height	Debljina Thickness	Dužina Length	Dozvoljeno opterećenje Allowed load			Šifra artikla Article
					1.5 m	2.0 m	2.5 m	
	mm	mm	mm	mm	kg/m			PL
LNK 6 10 300 PL	100	60	1.5	3000	250	200	125	20010002
LNK 6 20 300 PL	200	60	1.5	3000	247	197	120	20010004
LNK 6 30 300 PL	300	60	1.5	3000	245	195	120	20010007
LNK 6 40 300 PL	400	60	1.5	3000	235	190	115	20010010
LNK 6 50 300 PL	500	60	1.5	3000	230	185	112	20010013
LNK 6 60 300 PL	600	60	1.5	3000	232	190	115	20010016
								TC
LNK 6 10 300 TC	100	60	1.5	3000	250	200	125	20020075
LNK 6 20 300 TC	200	60	1.5	3000	247	197	120	20020076
LNK 6 30 300 TC	300	60	1.5	3000	245	195	120	20020077
LNK 6 40 300 TC	400	60	1.5	3000	235	190	115	20020078
LNK 6 50 300 TC	500	60	1.5	3000	230	185	112	20020079
LNK 6 60 300 TC	600	60	1.5	3000	232	190	115	20020080

PL Pocinkovani lim / Galvanized sheet
 TC Toplo pocinkovano potapanjem / Hot - dip galvanized

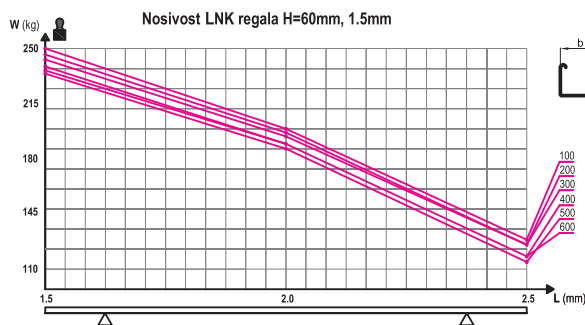

Nosač kablova VLNK / VLNK cable trays

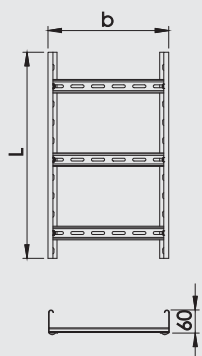

Tip Typ	Širina Width	Visina Height	Debljina Thickness	Dužina Length	Dozvoljeno opterećenje Allowed load			Šifra artikla Article
					1.5 m	2.0 m	2.5 m	
	mm	mm	mm	mm	kg/m			PL
VLNK 6 10 300 PL	100	60	2	3000	250	200	125	20040007
VLNK 6 20 300 PL	200	60	2	3000	247	197	120	20040008
VLNK 6 30 300 PL	300	60	2	3000	245	195	120	20040009
VLNK 6 40 300 PL	400	60	2	3000	235	190	115	20040010
VLNK 6 50 300 PL	500	60	2	3000	230	185	112	20040011
VLNK 6 60 300 PL	600	60	2	3000	232	190	115	20040012
								TC
VLNK 6 10 300 TC	100	60	2	3000	250	200	125	20020081
VLNK 6 20 300 TC	200	60	2	3000	247	197	120	20020082
VLNK 6 30 300 TC	300	60	2	3000	245	195	120	20020083
VLNK 6 40 300 TC	400	60	2	3000	235	190	115	20020084
VLNK 6 50 300 TC	500	60	2	3000	230	185	112	20020085
VLNK 6 60 300 TC	600	60	2	3000	232	190	115	20020086

PL Pocinkovani lim / Galvanized sheet
 TC Toplo pocinkovano potapanjem / Hot - dip galvanized

Lestvica nosači kablova

Bočna spojnica / Straight connector

H60

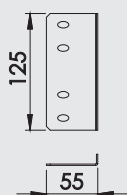

Tip Typ	Širina Width	Visina Height	Debljina Thickness	Šifra artikla Article
S LNK 100 PL	100	60	1.5	PL 20030062
S LNK 100 TC	100	60	1.5	TC 20020087

PL Pocinkovani lim / Galvanized sheet TC Toplo pocinkovano potapanjem / Hot - dip galvanized



Bočna spojnica VLNK / VLNK Straight connector

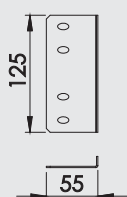

Tip Typ	Širina Width	Visina Height	Debljina Thickness	Šifra artikla Article
S VLNK 100 PL	100	60	2	PL 20030063
S VLNK 100 TC	100	60	2	TC 20020088

PL Pocinkovani lim / Galvanized sheet TC Toplo pocinkovano potapanjem / Hot - dip galvanized



Pregrada / Divider

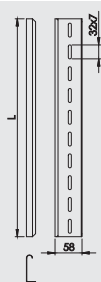

Tip Typ	Visina Height	Dužina Length	Pakovanje Pack kom piece	Šifra artikla Article
P PNK 60 PL	60	3000	10	PL 10030120
P PNK 60 TC	60	3000	10	TC 10020118

PL Pocinkovani lim / Galvanized sheet TC Toplo pocinkovano potapanjem / Hot - dip galvanized

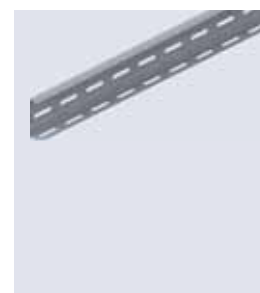

Lomljiva spojnica / Angle connector

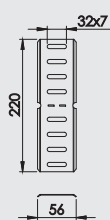

Tip Typ	Visina Height	Pakovanje Pack kom piece	Šifra artikla Article
LS PNK 60 PL	60	50	PL 10030122
LS PNK 60 TC	60	50	TC 10020120

PL Pocinkovani lim / Galvanized sheet TC Toplo pocinkovano potapanjem / Hot - dip galvanized

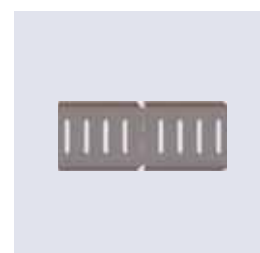

Zglobna spojnica / Adjustable connector



Tip Typ	Visina Height	Pakovanje Pack kom piece	Šifra artikla Article
ZS PNK 60 PL	60	50	PL 10030123
ZS PNK 60 TC	60	50	TC 10020121

PL Pocinkovani lim / Galvanized sheet TC Toplo pocinkovano potapanjem / Hot - dip galvanized

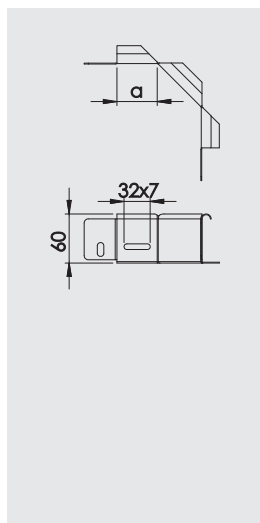

Ugaona spojnica / Corner connector

H60

Tip Typ	Širina Width	Visina Height	Debljina Thickness	Šifra artikla Article
	mm	mm	mm	
				PL
US PNK 6 5 PL	50	60	1	10030148
US PNK 6 10 PL	100	60	1	10030149
US PNK 6 20 PL	200	60	1	10030151
US PNK 6 30 PL	300	60	1	10030152
US PNK 6 40 PL	400	60	1	10030153
US PNK 6 50 PL	500	60	1	10030154
US PNK 6 60 PL	600	60	1	10030155
				TC
US PNK 6 5 TC	50	60	1	10020146
US PNK 6 10 TC	100	60	1	10020147
US PNK 6 20 TC	200	60	1	10020149
US PNK 6 30 TC	300	60	1	10020150
US PNK 6 40 TC	400	60	1	10020151
US PNK 6 50 TC	500	60	1	10020152
US PNK 6 60 TC	600	60	1	10020153

PL Pocinkovani lim / Galvanized sheet

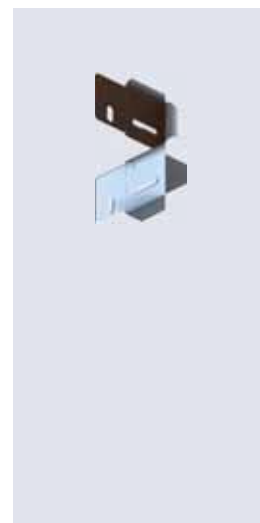
TC Toplo pocinkovano potapanjem / Hot - dip galvanized

Lestvica nosači kablova

Krivina 90° / Bend 90°

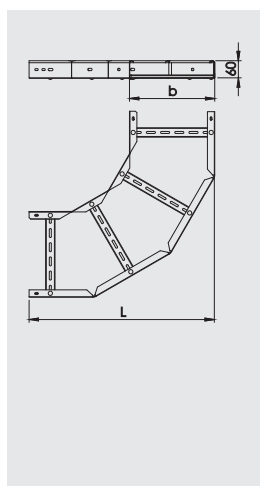

Tip Typ	Širina Width	Visina Height	Debljina Thickness	Šifra artikla Article
	mm	mm	mm	
				PL
L LNK 6 10 PL	100	60	1.5	20030064
L LNK 6 20 PL	200	60	1.5	20030065
L LNK 6 30 PL	300	60	1.5	20030066
L LNK 6 40 PL	400	60	1.5	20030067
L LNK 6 50 PL	500	60	1.5	20030068
L LNK 6 60 PL	600	60	1.5	20030069
				TC
L LNK 6 10 TC	100	60	1.5	20020089
L LNK 6 20 TC	200	60	1.5	20020090
L LNK 6 30 TC	300	60	1.5	20020091
L LNK 6 40 TC	400	60	1.5	20020092
L LNK 6 50 TC	500	60	1.5	20020093
L LNK 6 60 TC	600	60	1.5	20020094

PL Pocinkovani lim / Galvanized sheet

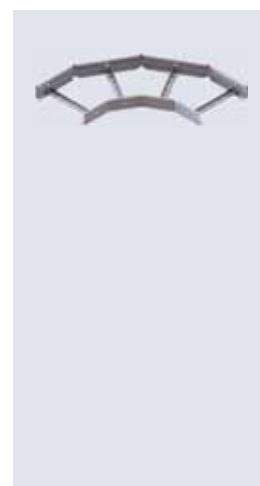
TC Toplo pocinkovano potapanjem / Hot - dip galvanized

Krivina 90° VLNK / VLNK Bend 90°

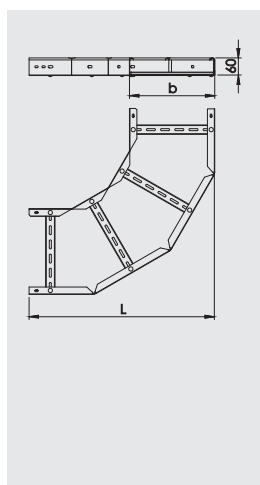

Tip Typ	Širina Width	Visina Height	Debljina Thickness	Šifra artikla Article
	mm	mm	mm	
				PL
L VLNK 6 10 PL	100	60	2	20030070
L VLNK 6 20 PL	200	60	2	20030071
L VLNK 6 30 PL	300	60	2	20030072
L VLNK 6 40 PL	400	60	2	20030073
L VLNK 6 50 PL	500	60	2	20030074
L VLNK 6 60 PL	600	60	2	20030075
				TC
L VLNK 6 10 TC	100	60	2	20020095
L VLNK 6 20 TC	200	60	2	20020096
L VLNK 6 30 TC	300	60	2	20020097
L VLNK 6 40 TC	400	60	2	20020098
L VLNK 6 50 TC	500	60	2	20020099
L VLNK 6 60 TC	600	60	2	20020100

PL Pocinkovani lim / Galvanized sheet

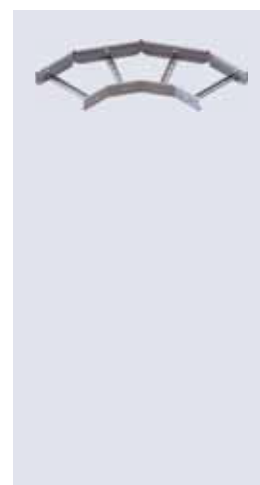
TC Toplo pocinkovano potapanjem / Hot - dip galvanized

T račva / T Module

H60

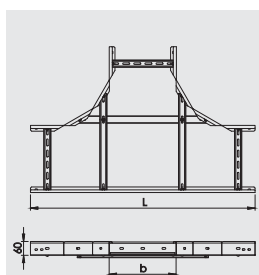

Tip Typ	Širina Width	Visina Height	Debljina Thickness	Šifra artikla Article
	mm	mm	mm	PL
T LNK 6 10 PL	100	60	1.5	20030076
T LNK 6 20 PL	200	60	1.5	20030077
T LNK 6 30 PL	300	60	1.5	20030078
T LNK 6 40 PL	400	60	1.5	20030079
T LNK 6 50 PL	500	60	1.5	20030080
T LNK 6 60 PL	600	60	1.5	20030081
				TC
T LNK 6 10 TC	100	60	1.5	20020101
T LNK 6 20 TC	200	60	1.5	20020102
T LNK 6 30 TC	300	60	1.5	20020103
T LNK 6 40 TC	400	60	1.5	20020104
T LNK 6 50 TC	500	60	1.5	20020105
T LNK 6 60 TC	600	60	1.5	20020106

PL Pocinkovani lim / Galvanized sheet **TC** Toplo pocinkovano potapanjem / Hot - dip galvanized



T račva VLNK / VLNK T Module

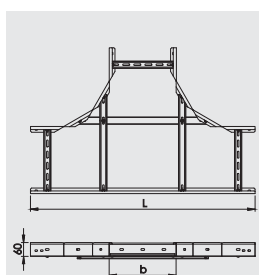

Tip Typ	Širina Width	Visina Height	Debljina Thickness	Šifra artikla Article
	mm	mm	mm	PL
T VLNK 6 10 PL	100	60	2	20030082
T VLNK 6 20 PL	200	60	2	20030083
T VLNK 6 30 PL	300	60	2	20030084
T VLNK 6 40 PL	400	60	2	20030085
T VLNK 6 50 PL	500	60	2	20030086
T VLNK 6 60 PL	600	60	2	20030087
				TC
T VLNK 6 10 TC	100	60	2	20020107
T VLNK 6 20 TC	200	60	2	20020108
T VLNK 6 30 TC	300	60	2	20020109
T VLNK 6 40 TC	400	60	2	20020110
T VLNK 6 50 TC	500	60	2	20020111
T VLNK 6 60 TC	600	60	2	20020112

PL Pocinkovani lim / Galvanized sheet **TC** Toplo pocinkovano potapanjem / Hot - dip galvanized



Račva plus / + Connection module

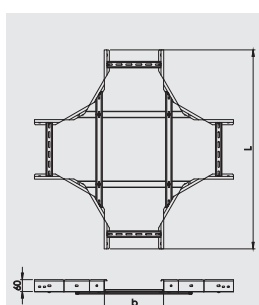

Tip Typ	Širina Width	Visina Height	Debljina Thickness	Šifra artikla Article
	mm	mm	mm	PL
X LNK 6 10 PL	100	60	1.5	20030088
X LNK 6 20 PL	200	60	1.5	20030089
X LNK 6 30 PL	300	60	1.5	20030090
X LNK 6 40 PL	400	60	1.5	20030091
X LNK 6 50 PL	500	60	1.5	20030092
X LNK 6 60 PL	600	60	1.5	20030093
				TC
X LNK 6 10 TC	100	60	1.5	20020113
X LNK 6 20 TC	200	60	1.5	20020114
X LNK 6 30 TC	300	60	1.5	20020115
X LNK 6 40 TC	400	60	1.5	20020116
X LNK 6 50 TC	500	60	1.5	20020117
X LNK 6 60 TC	600	60	1.5	20020118

PL Pocinkovani lim / Galvanized sheet **TC** Toplo pocinkovano potapanjem / Hot - dip galvanized

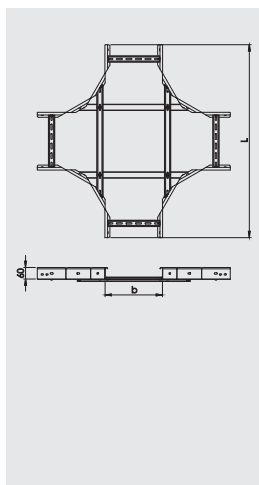

Račva plus VLNK / VLNK + Connection module

H60

Tip Typ	Širina Width	Visina Height	Debljina Thickness	Šifra artikla Article
	mm	mm	mm	PL
X VLNK 6 10 PL	100	60	2	20030094
X VLNK 6 20 PL	200	60	2	20030095
X VLNK 6 30 PL	300	60	2	20030096
X VLNK 6 40 PL	400	60	2	20030097
X VLNK 6 50 PL	500	60	2	20030098
X VLNK 6 60 PL	600	60	2	20030099
				TC
X VLNK 6 10 TC	100	60	2	20020119
X VLNK 6 20 TC	200	60	2	20020120
X VLNK 6 30 TC	300	60	2	20020121
X VLNK 6 40 TC	400	60	2	20020122
X VLNK 6 50 TC	500	60	2	20020123
X VLNK 6 60 TC	600	60	2	20020124

PL Pocinkovani lim / Galvanized sheet
 TC Toplo pocinkovano potapanjem / Hot - dip galvanized



Lestvičasti nosači kablova

Elementi zglobovno vertikalne krivine / Adjustable vertical bend element

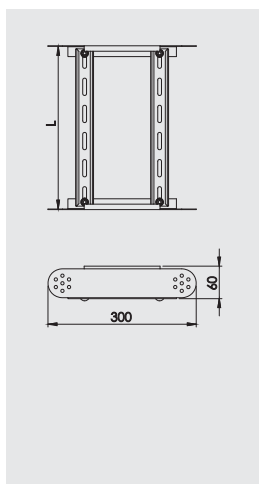

Tip Typ	Širina Width	Visina Height	Debljina Thickness	Šifra artikla Article
	mm	mm	mm	PL
EZK LNK 6 10 PL	100	60	1.5	20030100
EZK LNK 6 20 PL	200	60	1.5	20030101
EZK LNK 6 30 PL	300	60	1.5	20030102
EZK LNK 6 40 PL	400	60	1.5	20030103
EZK LNK 6 50 PL	500	60	1.5	20030104
EZK LNK 6 60 PL	600	60	1.5	20030105
				TC
EZK LNK 6 10 TC	100	60	1.5	20020125
EZK LNK 6 20 TC	200	60	1.5	20020126
EZK LNK 6 30 TC	300	60	1.5	20020127
EZK LNK 6 40 TC	400	60	1.5	20020128
EZK LNK 6 50 TC	500	60	1.5	20020129
EZK LNK 6 60 TC	600	60	1.5	20020130

PL Pocinkovani lim / Galvanized sheet
 TC Toplo pocinkovano potapanjem / Hot - dip galvanized



Elementi zglobovno vertikalne krivine VLNK / VLNK Adjustable vertical bend element

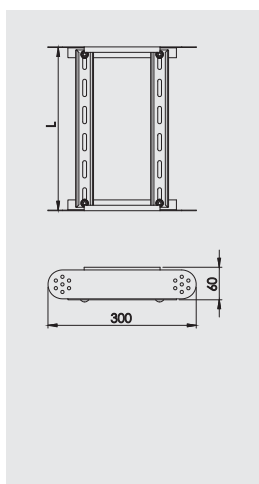

Tip Typ	Širina Width	Visina Height	Debljina Thickness	Šifra artikla Article
	mm	mm	mm	PL
EZK VLNK 6 10 PL	100	60	2	20030106
EZK VLNK 6 20 PL	200	60	2	20030107
EZK VLNK 6 30 PL	300	60	2	20030108
EZK VLNK 6 40 PL	400	60	2	20030109
EZK VLNK 6 50 PL	500	60	2	20030110
EZK VLNK 6 60 PL	600	60	2	20030111
				TC
EZK VLNK 6 10 TC	100	60	2	20020131
EZK VLNK 6 20 TC	200	60	2	20020132
EZK VLNK 6 30 TC	300	60	2	20020133
EZK VLNK 6 40 TC	400	60	2	20020134
EZK VLNK 6 50 TC	500	60	2	20020135
EZK VLNK 6 60 TC	600	60	2	20020136

PL Pocinkovani lim / Galvanized sheet
 TC Toplo pocinkovano potapanjem / Hot - dip galvanized



Zglobno vertikalna krivina / Adjustable vertical bend

H60

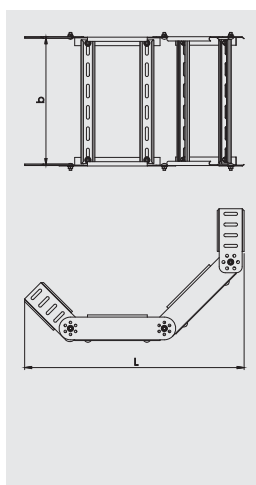

Tip Typ	Širina Width	Visina Height	Debljina Thickness	Šifra artikla Article
	mm	mm	mm	
ZK LNK 6 10 PL	100	60	1.5	20030112
ZK LNK 6 20 PL	200	60	1.5	20030113
ZK LNK 6 30 PL	300	60	1.5	20030114
ZK LNK 6 40 PL	400	60	1.5	20030115
ZK LNK 6 50 PL	500	60	1.5	20030116
ZK LNK 6 60 PL	600	60	1.5	20030117
				TC
ZK LNK 6 10 TC	100	60	1.5	20020137
ZK LNK 6 20 TC	200	60	1.5	20020138
ZK LNK 6 30 TC	300	60	1.5	20020139
ZK LNK 6 40 TC	400	60	1.5	20020140
ZK LNK 6 50 TC	500	60	1.5	20020141
ZK LNK 6 60 TC	600	60	1.5	20020142

PL Pocinkovani lim / Galvanized sheet **TC** Toplo pocinkovano potapanjem / Hot - dip galvanized



Zglobno vertikalna krivina VLNK / VLNK Adjustable vertical bend

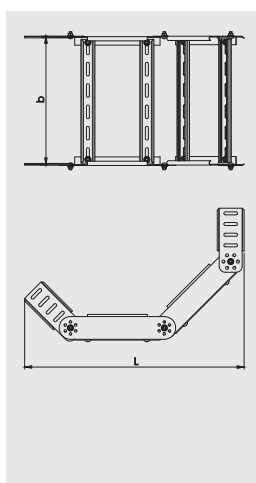

Tip Typ	Širina Width	Visina Height	Debljina Thickness	Šifra artikla Article
	mm	mm	mm	
ZK VLNK 6 10 PL	100	60	2	20030118
ZK VLNK 6 20 PL	200	60	2	20030119
ZK VLNK 6 30 PL	300	60	2	20030120
ZK VLNK 6 40 PL	400	60	2	20030121
ZK VLNK 6 50 PL	500	60	2	20030122
ZK VLNK 6 60 PL	600	60	2	20030123
				TC
ZK VLNK 6 10 TC	100	60	2	20020143
ZK VLNK 6 20 TC	200	60	2	20020144
ZK VLNK 6 30 TC	300	60	2	20020145
ZK VLNK 6 40 TC	400	60	2	20020146
ZK VLNK 6 50 TC	500	60	2	20020147
ZK VLNK 6 60 TC	600	60	2	20020148

PL Pocinkovani lim / Galvanized sheet **TC** Toplo pocinkovano potapanjem / Hot - dip galvanized



Lučna obujmica LNK / LNK cable clamp

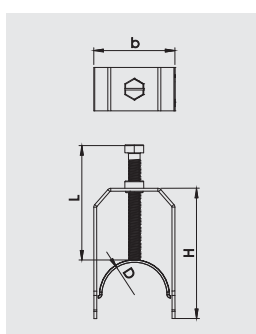

Tip Typ	Širina b Width b	Visina H Height H	Debljina Thickness	Dužina navoja L Thread length	Zatezna oblast D Clamping range D	Šifra artikla Article
	mm	mm	mm	mm	mm	
LNK obujmica 40 PL	40	50	1.5	50	30-41	20030186
LNK obujmica 56 PL	56	76	1.5	50	47-60	20030187
						TC
LNK obujmica 40 TC	40	50	1.5	50	30-41	20020223
LNK obujmica 56 TC	56	76	1.5	50	47-60	20020224

PL Pocinkovani lim / Galvanized sheet **TC** Toplo pocinkovano potapanjem / Hot - dip galvanized

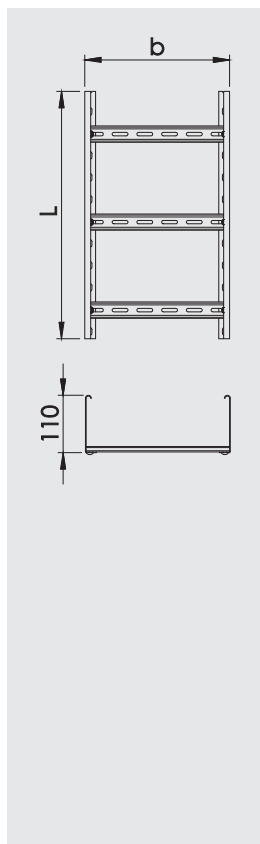

Nosač kablova LNK / Ladder cable trays

H110

Tip Typ	Širina Width	Visina Height	Debljina Thickness	Dužina Length	Dozvoljeno opterećenje Allowed load			Šifra artikla Article
					1.5 m	2.0 m	2.5 m	
LNK 11 10 300 PL	100	110	1.5	3000	355	275	205	20010000
LNK 11 20 300 PL	200	110	1.5	3000	350	270	200	20010005
LNK 11 30 300 PL	300	110	1.5	3000	350	265	180	20010008
LNK 11 40 300 PL	400	110	1.5	3000	332	255	180	20010011
LNK 11 50 300 PL	500	110	1.5	3000	324	240	180	20010014
LNK 11 60 300 PL	600	110	1.5	3000	318	230	160	20010017
TC								
LNK 11 10 300 TC	100	110	1.5	3000	355	275	205	20020149
LNK 11 20 300 TC	200	110	1.5	3000	350	270	200	20020150
LNK 11 30 300 TC	300	110	1.5	3000	350	265	180	20020151
LNK 11 40 300 TC	400	110	1.5	3000	332	255	180	20020152
LNK 11 50 300 TC	500	110	1.5	3000	324	240	180	20020153
LNK 11 60 300 TC	600	110	1.5	3000	318	230	160	20020154

PL Pocinkovani lim / Galvanized sheet **TC** Toplo pocinkovano potapanjem / Hot - dip galvanized

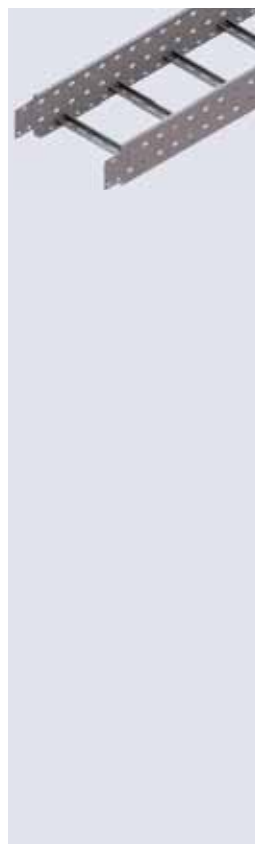
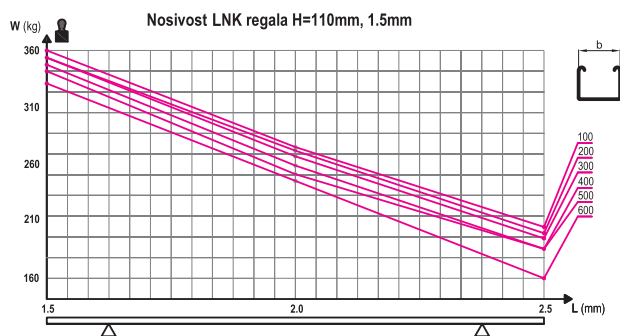

Lestvica nosači kablova

Nosač kablova VLNK / VLNK cable trays

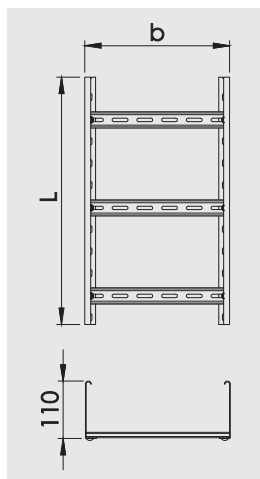

Tip Typ	Širina Width	Visina Height	Debljina Thickness	Dužina Length	Dozvoljeno opterećenje Allowed load			Šifra artikla Article
					1.5 m	2.0 m	2.5 m	
PL								
VLNK 11 10 300 PL	100	110	2	3000	355	275	205	20040013
VLNK 11 20 300 PL	200	110	2	3000	350	270	200	20040014
VLNK 11 30 300 PL	300	110	2	3000	350	265	180	20040015
VLNK 11 40 300 PL	400	110	2	3000	332	255	180	20040016
VLNK 11 50 300 PL	500	110	2	3000	324	240	180	20040017
VLNK 11 60 300 PL	600	110	2	3000	318	230	160	20040018
TC								
VLNK 11 10 300 TC	100	110	2	3000	355	275	205	20020155
VLNK 11 20 300 TC	200	110	2	3000	350	270	200	20020156
VLNK 11 30 300 TC	300	110	2	3000	350	265	180	20020157
VLNK 11 40 300 TC	400	110	2	3000	332	255	180	20020158
VLNK 11 50 300 TC	500	110	2	3000	324	240	180	20020159
VLNK 11 60 300 TC	600	110	2	3000	318	230	160	20020160

PL Pocinkovani lim / Galvanized sheet **TC** Toplo pocinkovano potapanjem / Hot - dip galvanized



Bočna spojnica / Straight connector

H110

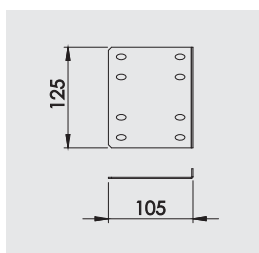

Tip Typ	Širina Width	Visina Height	Debljina Thickness	Šifra artikla Article
S LNK 110 PL	mm 100	mm 110	mm 1.5	PL 20030124
S LNK 110 TC	100	110	1.5	TC 20020161

PL Pocinkovani lim / Galvanized sheet **TC** Toplo pocinkovano potapanjem / Hot - dip galvanized



Bočna spojnica VLNK / VLNK Straight connector

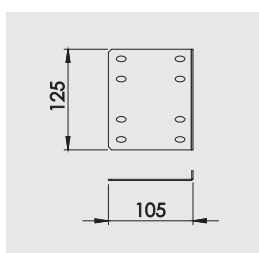

Tip Typ	Širina Width	Visina Height	Debljina Thickness	Šifra artikla Article
S VLNK 110 PL	mm 100	mm 110	mm 2	PL 20030125
S VLNK 110 TC	100	110	2	TC 20020162

PL Pocinkovani lim / Galvanized sheet **TC** Toplo pocinkovano potapanjem / Hot - dip galvanized



Pregrada / Divider

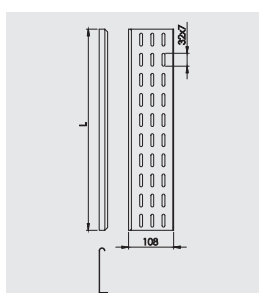

Tip Typ	Visina Height	Dužina Length	Pakovanje Pack kom piece	Šifra artikla Article
P PNK 110 PL	mm 110	mm 3000	50	PL 10030255
P PNK 110 TC	110	3000	50	TC 10020281

PL Pocinkovani lim / Galvanized sheet **TC** Toplo pocinkovano potapanjem / Hot - dip galvanized

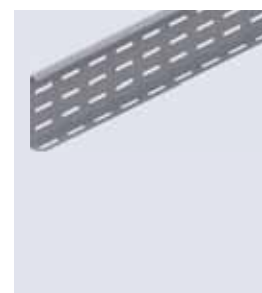

Lomljiva spojnica / Angle connector

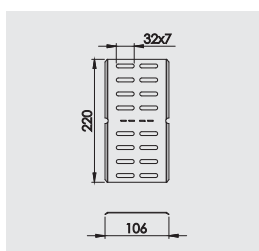

Tip Typ	Visina Height	Pakovanje Pack kom piece	Šifra artikla Article
LS PNK 110 PL	mm 110	50	PL 10030257
LS PNK 110 TC	110	50	TC 10020283

PL Pocinkovani lim / Galvanized sheet **TC** Toplo pocinkovano potapanjem / Hot - dip galvanized



Zglobna spojnica / Adjustable connector

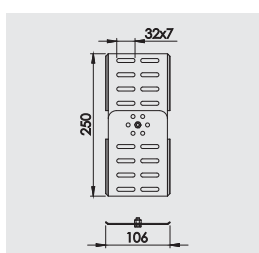

Tip Typ	Visina Height	Pakovanje Pack kom piece	Šifra artikla Article
ZS PNK 110 PL	mm 110	50	PL 10030258
ZS PNK 110 TC	110	50	TC 10020284

PL Pocinkovani lim / Galvanized sheet **TC** Toplo pocinkovano potapanjem / Hot - dip galvanized

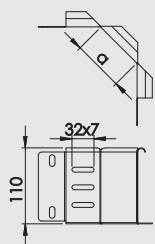

Ugaona spojnica / Corner connector

H110

Tip Typ	Širina Width	Visina Height	Debljina Thickness	Šifra artikla Article
	mm	mm	mm	PL
US PNK 11 10 PL	100	110	1.5	10030280
US PNK 11 20 PL	200	110	1.5	10030282
US PNK 11 30 PL	300	110	1.5	10030283
US PNK 11 40 PL	400	110	1.5	10030284
US PNK 11 50 PL	500	110	1.5	10030285
US PNK 11 60 PL	600	110	1.5	10030286
				TC
US PNK 11 10 TC	100	110	1.5	10020306
US PNK 11 20 TC	200	110	1.5	10020308
US PNK 11 30 TC	300	110	1.5	10020309
US PNK 11 40 TC	400	110	1.5	10020310
US PNK 11 50 TC	500	110	1.5	10020311
US PNK 11 60 TC	600	110	1.5	10020312

PL Pocinkovani lim / Galvanized sheet
 TC Toplo pocinkovano potapanjem / Hot - dip galvanized



Lestvičasti nosači kablova

Krivina 90° / Bend 90°

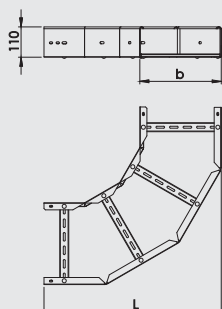

Tip Typ	Širina Width	Visina Height	Debljina Thickness	Šifra artikla Article
	mm	mm	mm	PL
L LNK 11 10 PL	100	110	1.5	20030126
L LNK 11 20 PL	200	110	1.5	20030127
L LNK 11 30 PL	300	110	1.5	20030128
L LNK 11 40 PL	400	110	1.5	20030129
L LNK 11 50 PL	500	110	1.5	20030130
L LNK 11 60 PL	600	110	1.5	20030131
				TC
L LNK 11 10 TC	100	110	1.5	20020163
L LNK 11 20 TC	200	110	1.5	20020164
L LNK 11 30 TC	300	110	1.5	20020165
L LNK 11 40 TC	400	110	1.5	20020166
L LNK 11 50 TC	500	110	1.5	20020167
L LNK 11 60 TC	600	110	1.5	20020168

PL Pocinkovani lim / Galvanized sheet
 TC Toplo pocinkovano potapanjem / Hot - dip galvanized



Krivina 90° VLNK / VLNK Bend 90°

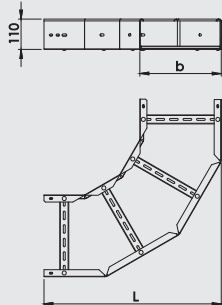

Tip Typ	Širina Width	Visina Height	Debljina Thickness	Šifra artikla Article
	mm	mm	mm	PL
L VLNK 11 10 PL	100	110	2	20030132
L VLNK 11 20 PL	200	110	2	20030133
L VLNK 11 30 PL	300	110	2	20030134
L VLNK 11 40 PL	400	110	2	20030135
L VLNK 11 50 PL	500	110	2	20030136
L VLNK 11 60 PL	600	110	2	20030137
				TC
L VLNK 11 10 TC	100	110	2	20020169
L VLNK 11 20 TC	200	110	2	20020170
L VLNK 11 30 TC	300	110	2	20020171
L VLNK 11 40 TC	400	110	2	20020172
L VLNK 11 50 TC	500	110	2	20020173
L VLNK 11 60 TC	600	110	2	20020174

PL Pocinkovani lim / Galvanized sheet
 TC Toplo pocinkovano potapanjem / Hot - dip galvanized



T račva / T Module

H110

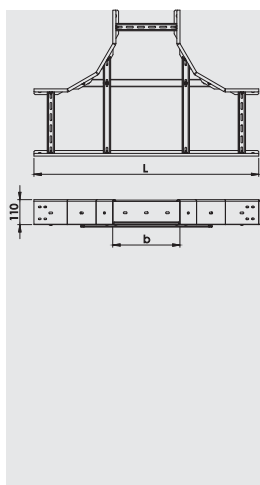

Tip Typ	Širina Width	Visina Height	Debljina Thickness	Šifra artikla Article
	mm	mm	mm	PL
T LNK 11 10 PL	100	110	1.5	20030138
T LNK 11 20 PL	200	110	1.5	20030139
T LNK 11 30 PL	300	110	1.5	20030140
T LNK 11 40 PL	400	110	1.5	20030141
T LNK 11 50 PL	500	110	1.5	20030142
T LNK 11 60 PL	600	110	1.5	20030143
				TC
T LNK 11 10 TC	100	110	1.5	20020175
T LNK 11 20 TC	200	110	1.5	20020176
T LNK 11 30 TC	300	110	1.5	20020177
T LNK 11 40 TC	400	110	1.5	20020178
T LNK 11 50 TC	500	110	1.5	20020179
T LNK 11 60 TC	600	110	1.5	20020180

 Pocinkovani lim / Galvanized sheet

 Toplo pocinkovano potapanjem / Hot - dip galvanized

T račva VLNK / VLNK T Module

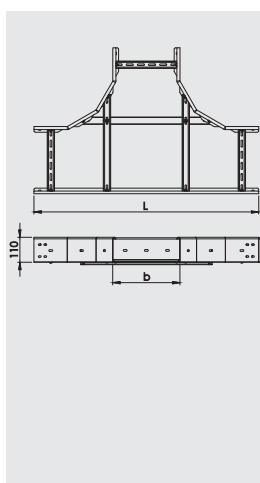

Tip Typ	Širina Width	Visina Height	Debljina Thickness	Šifra artikla Article
	mm	mm	mm	PL
T VLNK 11 10 PL	100	110	2	20030144
T VLNK 11 20 PL	200	110	2	20030145
T VLNK 11 30 PL	300	110	2	20030146
T VLNK 11 40 PL	400	110	2	20030147
T VLNK 11 50 PL	500	110	2	20030148
T VLNK 11 60 PL	600	110	2	20030149
				TC
T VLNK 11 10 TC	100	110	2	20020181
T VLNK 11 20 TC	200	110	2	20020182
T VLNK 11 30 TC	300	110	2	20020183
T VLNK 11 40 TC	400	110	2	20020184
T VLNK 11 50 TC	500	110	2	20020185
T VLNK 11 60 TC	600	110	2	20020186

 Pocinkovani lim / Galvanized sheet

 Toplo pocinkovano potapanjem / Hot - dip galvanized

Račva plus / + Connection module

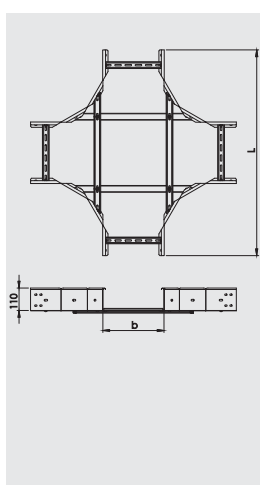

Tip Typ	Širina Width	Visina Height	Debljina Thickness	Šifra artikla Article
	mm	mm	mm	PL
X LNK 11 10 PL	100	110	1.5	20030150
X LNK 11 20 PL	200	110	1.5	20030151
X LNK 11 30 PL	300	110	1.5	20030152
X LNK 11 40 PL	400	110	1.5	20030153
X LNK 11 50 PL	500	110	1.5	20030154
X LNK 11 60 PL	600	110	1.5	20030155
				TC
X LNK 11 10 TC	100	110	1.5	20020187
X LNK 11 20 TC	200	110	1.5	20020188
X LNK 11 30 TC	300	110	1.5	20020189
X LNK 11 40 TC	400	110	1.5	20020190
X LNK 11 50 TC	500	110	1.5	20020191
X LNK 11 60 TC	600	110	1.5	20020192

 Pocinkovani lim / Galvanized sheet

 Toplo pocinkovano potapanjem / Hot - dip galvanized

Račva plus VLNK / VLNK + Connection module

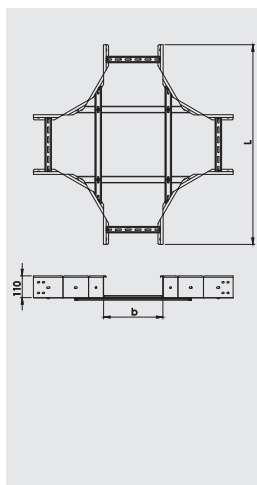
H110

Tip Typ	Širina Width	Visina Height	Debljina Thickness	Šifra artikla Article
	mm	mm	mm	PL
X VLNK 11 10 PL	100	110	2	20030156
X VLNK 11 20 PL	200	110	2	20030157
X VLNK 11 30 PL	300	110	2	20030158
X VLNK 11 40 PL	400	110	2	20030159
X VLNK 11 50 PL	500	110	2	20030160
X VLNK 11 60 PL	600	110	2	20030161
				TC
X VLNK 11 10 TC	100	110	2	20020193
X VLNK 11 20 TC	200	110	2	20020194
X VLNK 11 30 TC	300	110	2	20020195
X VLNK 11 40 TC	400	110	2	20020196
X VLNK 11 50 TC	500	110	2	20020197
X VLNK 11 60 TC	600	110	2	20020198

PL Pocinkovani lim / Galvanized sheet
 TC Toplo pocinkovano potapanjem / Hot - dip galvanized



Elementi zglobovno vertikalne krivine / Adjustable vertical bend element

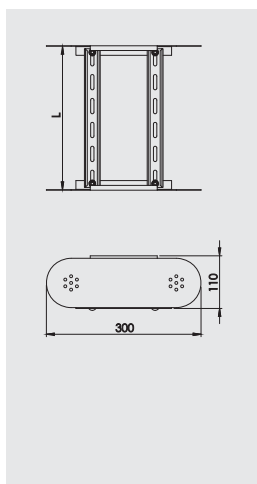

Tip Typ	Širina Width	Visina Height	Debljina Thickness	Šifra artikla Article
	mm	mm	mm	PL
EZK LNK 11 10 PL	100	110	1.5	20030162
EZK LNK 11 20 PL	200	110	1.5	20030163
EZK LNK 11 30 PL	300	110	1.5	20030164
EZK LNK 11 40 PL	400	110	1.5	20030165
EZK LNK 11 50 PL	500	110	1.5	20030166
EZK LNK 11 60 PL	600	110	1.5	20030167
				TC
EZK LNK 11 10 TC	100	110	1.5	20020199
EZK LNK 11 20 TC	200	110	1.5	20020200
EZK LNK 11 30 TC	300	110	1.5	20020201
EZK LNK 11 40 TC	400	110	1.5	20020202
EZK LNK 11 50 TC	500	110	1.5	20020203
EZK LNK 11 60 TC	600	110	1.5	20020204

PL Pocinkovani lim / Galvanized sheet
 TC Toplo pocinkovano potapanjem / Hot - dip galvanized



Elementi zglobovno vertikalne krivine VLNK / VLNK Adjustable vertical bend element

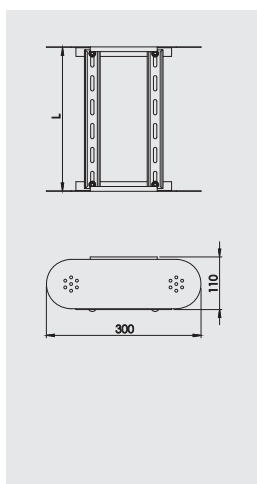

Tip Typ	Širina Width	Visina Height	Debljina Thickness	Šifra artikla Article
	mm	mm	mm	PL
EZK VLNK 11 10 PL	100	110	2	20030168
EZK VLNK 11 20 PL	200	110	2	20030169
EZK VLNK 11 30 PL	300	110	2	20030170
EZK VLNK 11 40 PL	400	110	2	20030171
EZK VLNK 11 50 PL	500	110	2	20030172
EZK VLNK 11 60 PL	600	110	2	20030173
				TC
EZK VLNK 11 10 TC	100	110	2	20020205
EZK VLNK 11 20 TC	200	110	2	20020206
EZK VLNK 11 30 TC	300	110	2	20020207
EZK VLNK 11 40 TC	400	110	2	20020208
EZK VLNK 11 50 TC	500	110	2	20020209
EZK VLNK 11 60 TC	600	110	2	20020210

PL Pocinkovani lim / Galvanized sheet
 TC Toplo pocinkovano potapanjem / Hot - dip galvanized



Zglobno vertikalna krivina / Adjustable vertical bend

H110

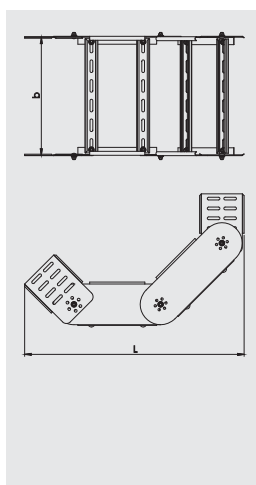

Tip Typ	Širina Width	Visina Height	Debljina Thickness	Šifra artikla Article
	mm	mm	mm	
ZK LNK 11 10 PL	100	110	1.5	20030174
ZK LNK 11 20 PL	200	110	1.5	20030175
ZK LNK 11 30 PL	300	110	1.5	20030176
ZK LNK 11 40 PL	400	110	1.5	20030177
ZK LNK 11 50 PL	500	110	1.5	20030178
ZK LNK 11 60 PL	600	110	1.5	20030179
ZK LNK 11 10 TC	100	110	1.5	20020211
ZK LNK 11 20 TC	200	110	1.5	20020212
ZK LNK 11 30 TC	300	110	1.5	20020213
ZK LNK 11 40 TC	400	110	1.5	20020214
ZK LNK 11 50 TC	500	110	1.5	20020215
ZK LNK 11 60 TC	600	110	1.5	20020216



PL Pocinkovani lim / Galvanized sheet TC Toplo pocinkovano potapanjem / Hot - dip galvanized

Zglobno vertikalna krivina VLNK / VLNK Adjustable vertical bend

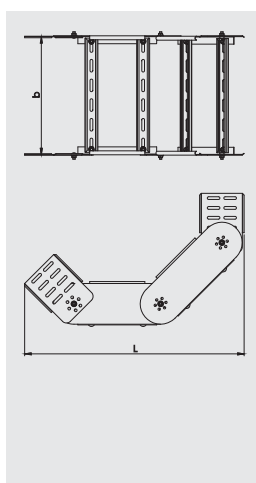

Tip Typ	Širina Width	Visina Height	Debljina Thickness	Šifra artikla Article
	mm	mm	mm	
ZK VLNK 11 10 PL	100	110	2	20030180
ZK VLNK 11 20 PL	200	110	2	20030181
ZK VLNK 11 30 PL	300	110	2	20030182
ZK VLNK 11 40 PL	400	110	2	20030183
ZK VLNK 11 50 PL	500	110	2	20030184
ZK VLNK 11 60 PL	600	110	2	20030185
ZK VLNK 11 10 TC	100	110	2	20020217
ZK VLNK 11 20 TC	200	110	2	20020218
ZK VLNK 11 30 TC	300	110	2	20020219
ZK VLNK 11 40 TC	400	110	2	20020220
ZK VLNK 11 50 TC	500	110	2	20020221
ZK VLNK 11 60 TC	600	110	2	20020222



PL Pocinkovani lim / Galvanized sheet TC Toplo pocinkovano potapanjem / Hot - dip galvanized

Lučna obujmica LNK / LNK cable clamp

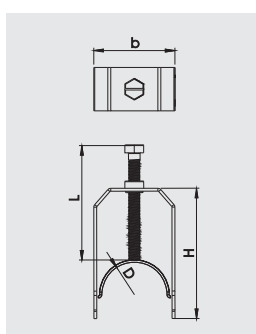

Tip Typ	Širina b Width b	Visina H Height H	Debljina Thickness	Dužina navoja L Thread length	Zatezna oblast D Clamping range D	Šifra artikla Article
	mm	mm	mm	mm	mm	
LNK obujmica 40 PL	40	50	1.5	50	30-41	20030186
LNK obujmica 56 PL	56	76	1.5	50	47-60	20030187
LNK obujmica 40 TC	40	50	1.5	50	30-41	20020223
LNK obujmica 56 TC	56	76	1.5	50	47-60	20020224



PL Pocinkovani lim / Galvanized sheet TC Toplo pocinkovano potapanjem / Hot - dip galvanized

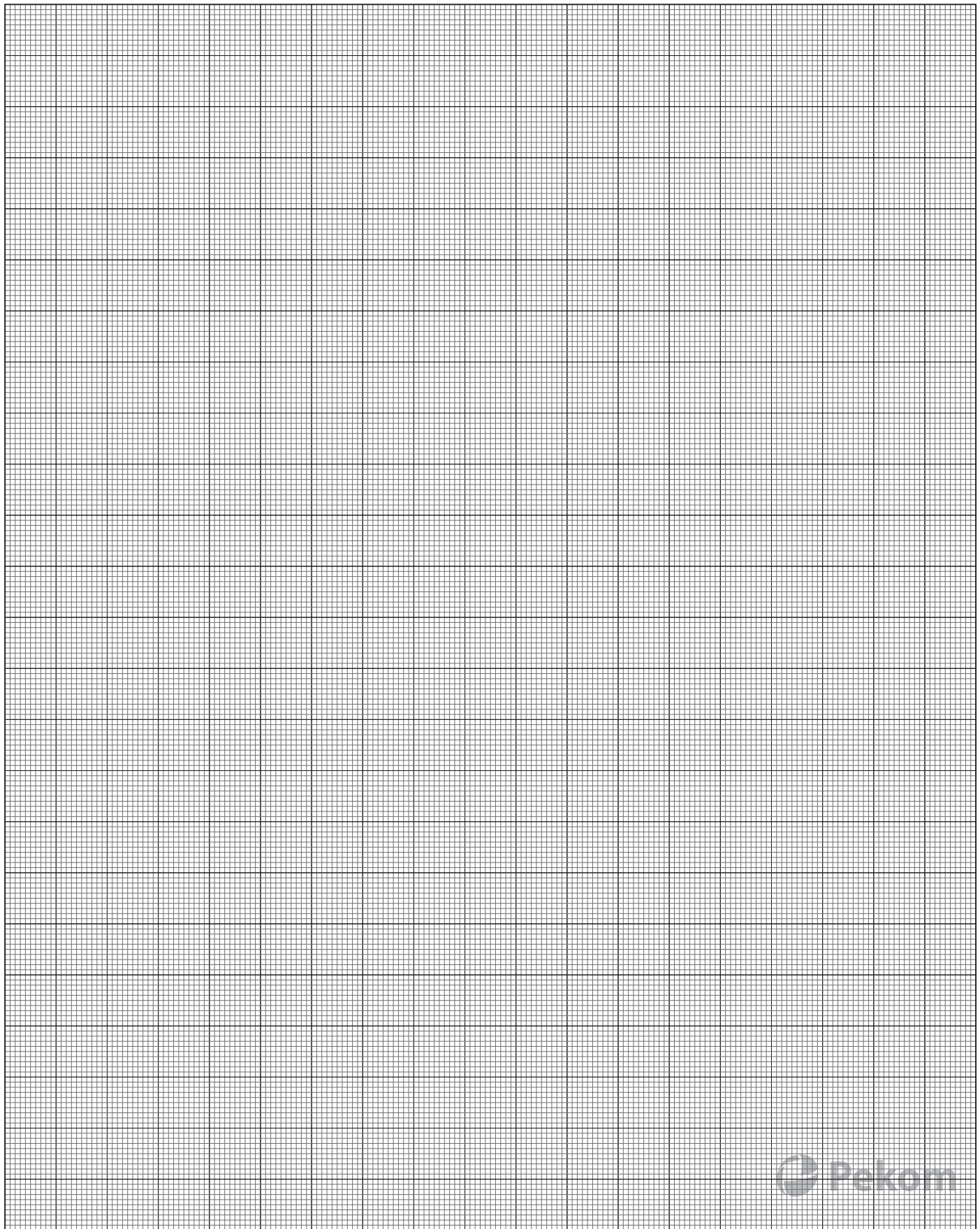

H55

H105



MNK

4

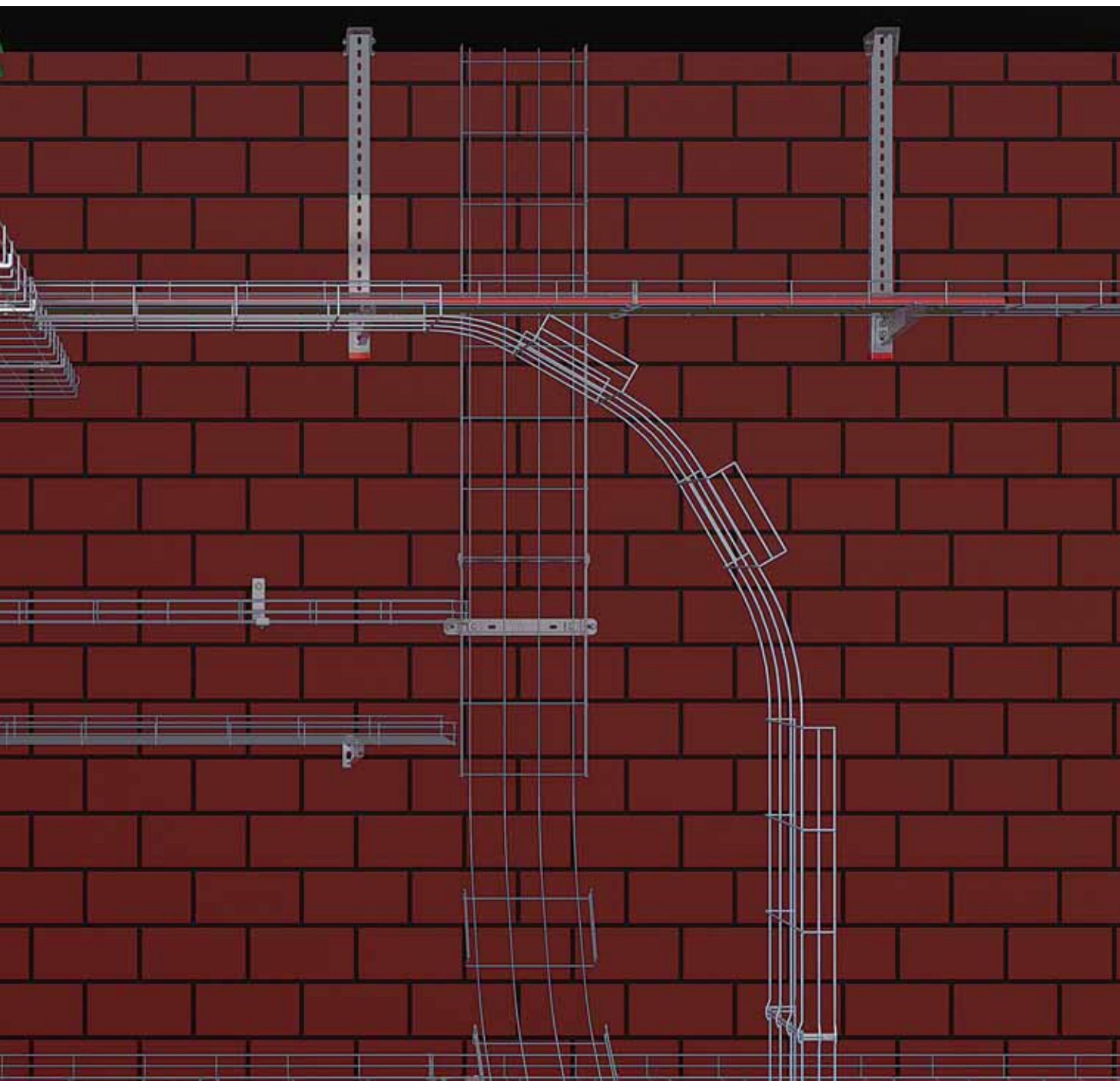

MREŽASTI NOSAČI KABLOVA

MESH CABLE TRAY SYSTEMS

Montažni sistemi

Perforirani nosači kablova

Lestvičasti nosači kablova

Mrežasti nosači kablova

E90 - Vatrootporni nosači

Nosači kablova za rasvetu

Nosači kablova od Inox-a

Plastificirani nosači kablova

Prčvrsni sistemi

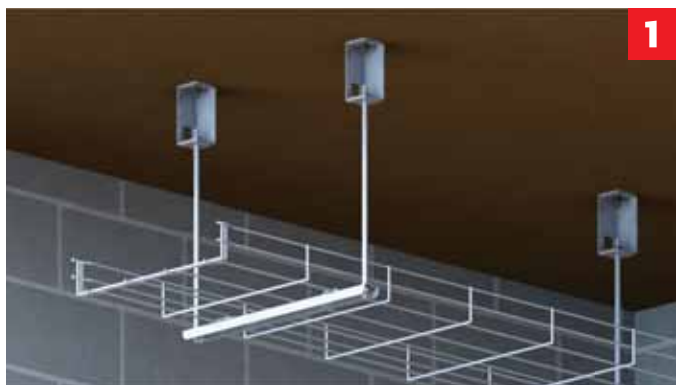
**1**

Za montažu mrežastog regala na plafon pomoću dve navojne šipke, koristi se standardna profilna šina za dve navojne šipke, kao dodatak za pričvršćivanje regala na šinu koriste se žabice PEKOM ŽMNK.

To montage MESH cable tray on the ceiling with two threaded rods, we use standard profile ray for two threaded rods, and PEKOM toggles ŽMNK, as an attachment to fasten cable tray to the ray.

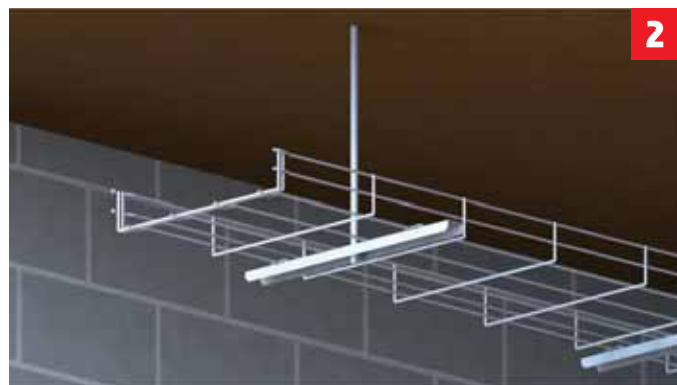
**2**

Za montažu mrežastog regala na plafon pomoću jedne navojne šipke koristi se standardna profilna šina za jednu navojnu šipku, kao dodatak za pričvršćivanje regala na šinu koriste se žabice PEKOM ŽMNK.

To montage MESH cable tray on the ceiling with one threaded rod, we use standard profile ray for one threaded rod, and PEKOM toggles ŽMNK, as an attachment to fasten cable tray to the ray.

**3**

Za montažu pregrade na mrežasti regal koristi se standardna pregrada za PNK regale, kao dodatak za pričvršćivanje pregrade na regal koriste se žabice PEKOM ŽMNK.

To montage barrier to the MESH cable tray, we use standard barrier for perforated cable carrier, and PEKOM toggles ŽMNK, as an attachment to fasten barrier to the cable tray.

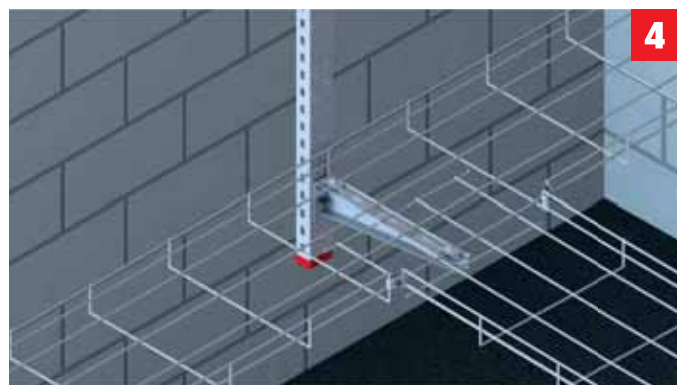
**4**

Princip montaže regala pomoću U stuba i konzole. Za montažu regala na konzolu koriste se žabice PEKOM ŽMNK.

The principle of the construction of the cable trays by using U profile pillar and cantilever. To montage MESH cable tray to the cantilever, we use PEKOM toggles ŽMNK.

**5**

Princip formiranja T raskrsnice pomoću žabica i torban vijaka tipa PEKOM M6x12.

The principle of forming T cross by using PEKOM toggles ŽMNK and PEKOM carriage bolts, type M6x12.

**6**

Spoj mrežastog regala tipa PEKOM.

The binding of the PEKOM mash cable tray system.

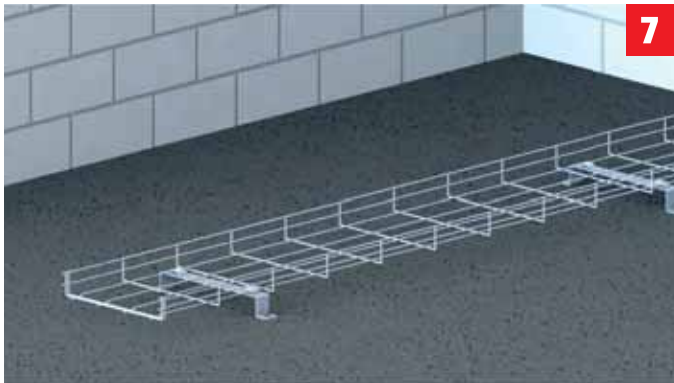

7

Za montažu mrežastog regala na pod pomoću odstoynika, koristi se standardni odstoynnik, kao dodatak za pričvršćivanje regala na odstoynnik koriste se žabice PEKOM ŽMKNK.

To montage MESH cable tray to the floor with the spacer, we use standard spacer, and PEKOM toggles ŽMKNK, as an attachment to fasten cable tray to the spacer.

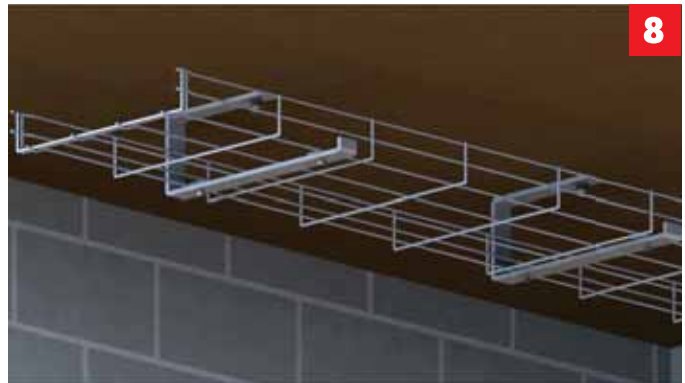

8

Za montažu mrežastog regala na plafon pomoću standardnog G nosača koristi se standardni G nosač, kao dodatak za pričvršćivanje regala na G nosač koriste se žabice PEKOM ŽMKNK.

To montage MESH cable tray on the ceiling by standard G carrier, we use standard G carrier, and PEKOM toggles ŽMKNK, as an attachment to fasten cable tray to the G carrier.

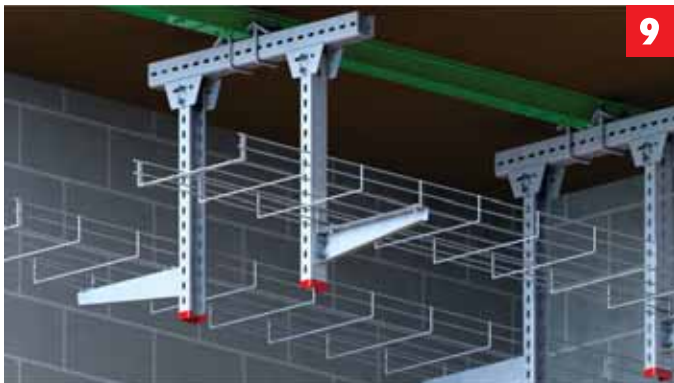

9

Princip izrade plafonske podkonstrukcije pomoću US 5 i US 7 profila koji se kače na I profil (bez bušenja I profila).

The principle of the construction of the ceiling substructure by using US 5 and US 7 profiles, that are attached to the I profile (without perforating the I profile).



10

Princip montaže regala pomoću U stuba i konzole. Za montažu regala na konzolu koriste se žabice PEKOM ŽMKNK.

The principle of the construction of the cable trays by using U profile pillar and cantilever. To montage cable tray to the cantilever, we use PEKOM toggles ŽMKNK.



11

Priprema mrežastog regala za spajanje jednostavnim klik sistemom.

Preparing MESH cable trays for binding by using simple click system.



12

MNK na konzolama.

MNK cable trays against the cantilevers.

Šema sečenja regala / Cutting scheme

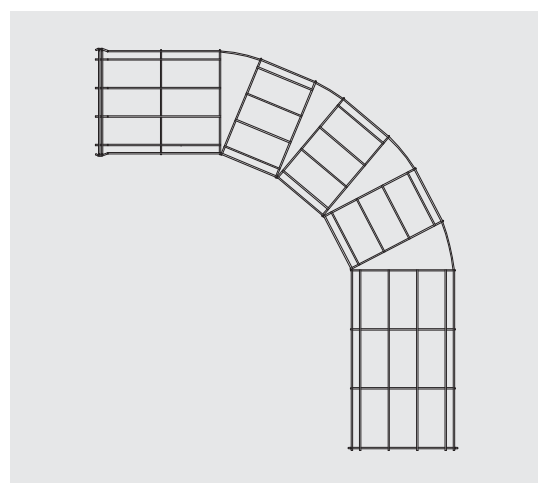
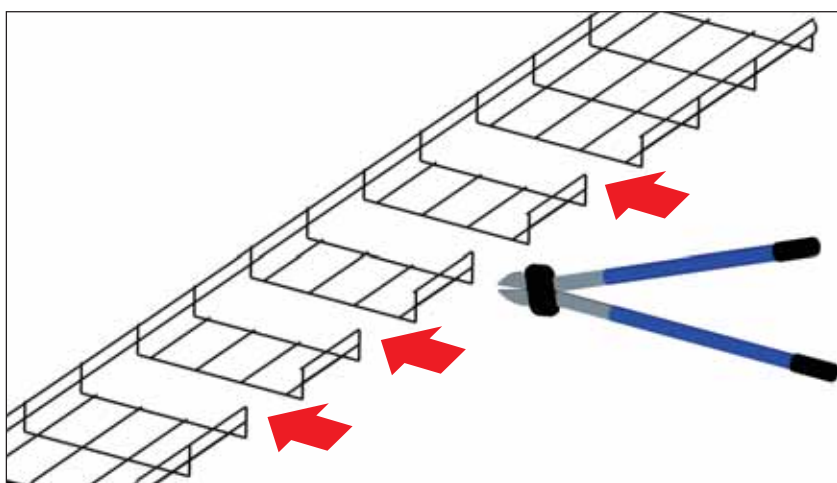
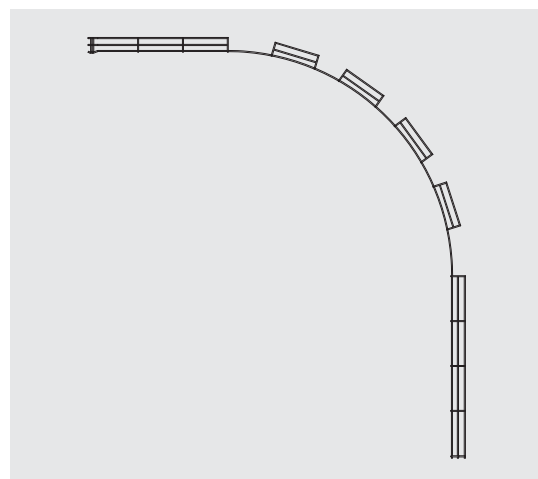
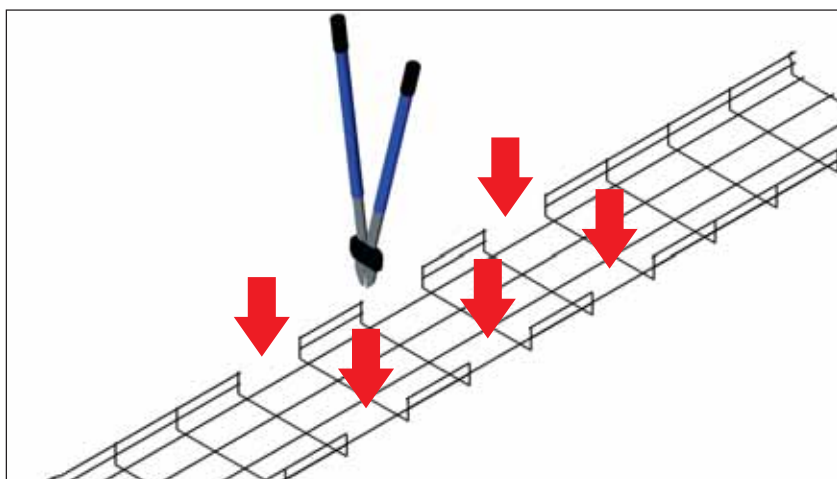
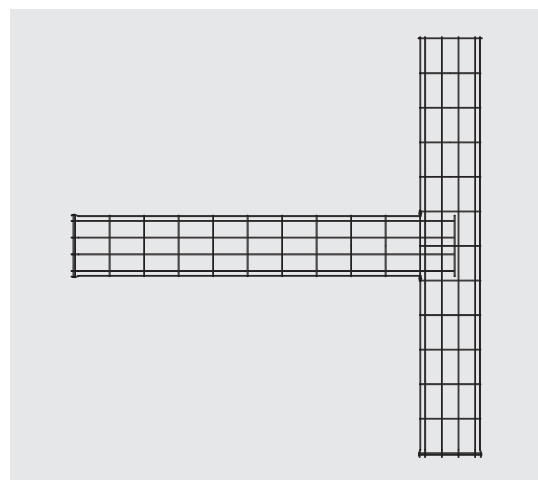
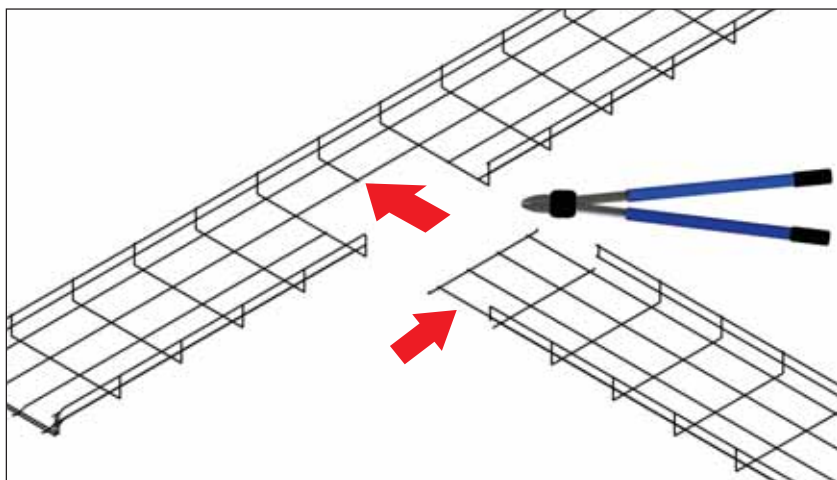

Mrežasti nosač kablova MNK L 2000mm H 55mm / Mesh cable trays MNK L 2000mm H 55mm

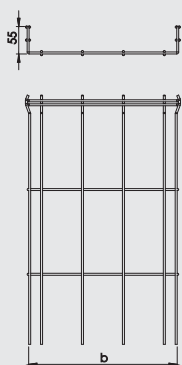
MNK

Tip Type	Širina Width	Visina Height	Debljina žice Wire thickness	Dužina Length	Korisni presek Useful section	Šifra artikla Article
	mm	mm	mm	mm	cm ²	GL
MNK 50/55/2000 GL	50	55	3.9	2000	25	50010001
MNK 100/55/2000 GL	100	55	3.9	2000	50	50010002
MNK 200/55/2000 GL	200	55	3.9	2000	100	50010003
MNK 300/55/2000 GL	300	55	3.9	2000	150	50010004
MNK 400/55/2000 GL	400	55	3.9	2000	200	50010005
MNK 500/55/2000 GL	500	55	4.9	2000	250	50010006
MNK 600/55/2000 GL	600	55	4.9	2000	300	50010007
						TC
MNK 50/55/2000 TC	50	55	3.9	2000	25	50020001
MNK 100/55/2000 TC	100	55	3.9	2000	50	50020002
MNK 200/55/2000 TC	200	55	3.9	2000	100	50020003
MNK 300/55/2000 TC	300	55	3.9	2000	150	50020004
MNK 400/55/2000 TC	400	55	3.9	2000	200	50020005
MNK 500/55/2000 TC	500	55	4.9	2000	250	50020006
MNK 600/55/2000 TC	600	55	4.9	2000	300	50020007

GL Galvanski pocinkovani lim / Galvanized sheet

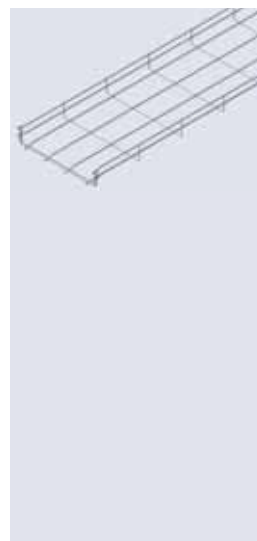
TC Toplo pocinkovano potapanjem / Hot - dip galvanized

Mrežasti nosač kablova MNK L 3000mm H 55mm / Mesh cable trays MNK L 3000mm H 55mm

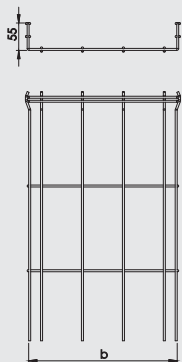

Tip Type	Širina Width	Visina Height	Debljina žice Wire thickness	Dužina Length	Korisni presek Useful section	Šifra artikla Article
	mm	mm	mm	mm	cm ²	GL
MNK 50/55/3000 GL	50	55	3.9	3000	25	50010008
MNK 100/55/3000 GL	100	55	3.9	3000	50	50010009
MNK 200/55/3000 GL	200	55	3.9	3000	100	50010010
MNK 300/55/3000 GL	300	55	3.9	3000	150	50010011
MNK 400/55/3000 GL	400	55	3.9	3000	200	50010012
MNK 500/55/3000 GL	500	55	4.9	3000	250	50010013
MNK 600/55/3000 GL	600	55	4.9	3000	300	50010014
						TC
MNK 50/55/3000 TC	50	55	3.9	3000	25	50020008
MNK 100/55/3000 TC	100	55	3.9	3000	50	50020009
MNK 200/55/3000 TC	200	55	3.9	3000	100	50020010
MNK 300/55/3000 TC	300	55	3.9	3000	150	50020011
MNK 400/55/3000 TC	400	55	3.9	3000	200	50020012
MNK 500/55/3000 TC	500	55	4.9	3000	250	50020013
MNK 600/55/3000 TC	600	55	4.9	3000	300	50020014

GL Galvanski pocinkovani lim / Galvanized sheet

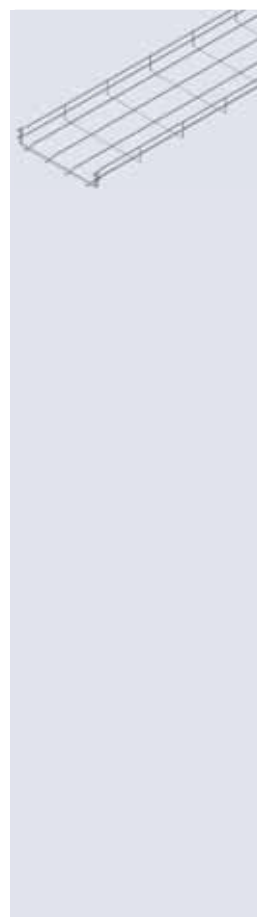
TC Toplo pocinkovano potapanjem / Hot - dip galvanized

Mrežasti nosači kablova

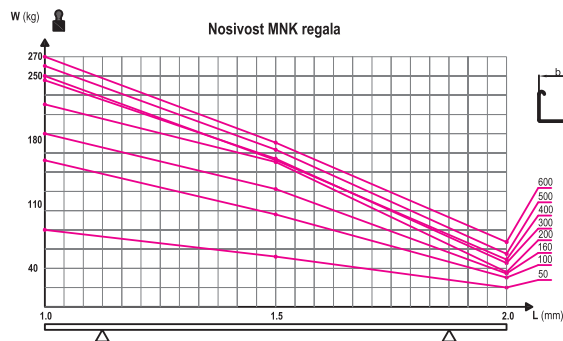

Mrežasti nosač kablova MNK L 3000mm H 105mm / Mesh cable trays L 3000mm H 105mm

MNK

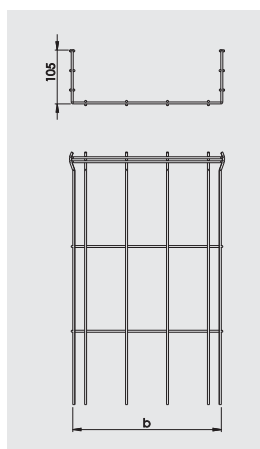

Tip Typ	Širina Width	Visina Height	Debljina žice Wire thickness	Dužina Length	Korisni presek Useful section	Šifra artikla Article
	mm	mm	mm	mm	cm ²	GL
MNK 50/105/3000 GL	50	105	3.9	3000	50	50010020
MNK 100/105/3000 GL	100	105	3.9	3000	100	50010021
MNK 200/105/3000 GL	200	105	3.9	3000	200	50010022
MNK 300/105/3000 GL	300	105	3.9	3000	300	50010023
MNK 400/105/3000 GL	400	105	3.9	3000	400	50010024
						TC
MNK 50/105/3000 TC	50	105	3.9	3000	50	50020020
MNK 100/105/3000 TC	100	105	3.9	3000	100	50020021
MNK 200/105/3000 TC	200	105	3.9	3000	200	50020022
MNK 300/105/3000 TC	300	105	3.9	3000	300	50020023
MNK 400/105/3000 TC	400	105	3.9	3000	400	50020024

GL Galvanski pocinkovani lim / Galvanized sheet

TC Toplo pocinkovano potapanjem / Hot - dip galvanized

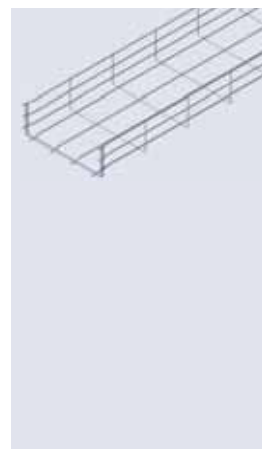

Žabica MNK regala / Toggle Mesh cable trays

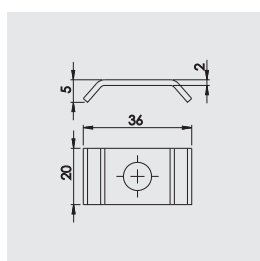

Tip Typ	Širina Width	Visina Height	Debljina lima Sheet thickness	Šifra artikla Article
	mm	mm	mm	GL
ŽMKN 1 GL	20	5	2	50010025
				TC
ŽMKN 1 TC	20	5	2	50020025

GL Galvanski pocinkovani lim / Galvanized sheet

TC Toplo pocinkovano potapanjem / Hot - dip galvanized



Pregrada H 50mm / Divider H 50mm

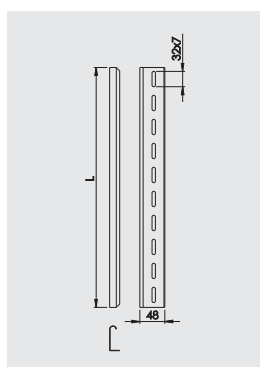

Tip Typ	Visina Height	Dužina Length	Pakovanje Pack kom piece	Šifra artikla Article
	mm	mm		PL
P PNK 50 PL	50	3000	10	10030046
				TC
P PNK 50 TC	50	3000	10	10020022

PL Pocinkovani lim / Galvanized sheet

TC Toplo pocinkovano potapanjem / Hot - dip galvanized

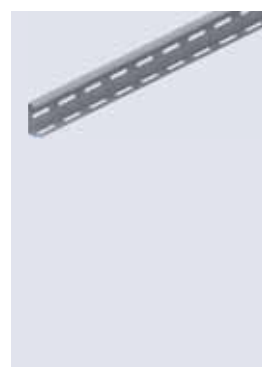

Pregrada H 110mm / Divider H 110mm

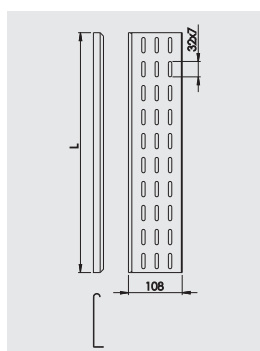

Tip Typ	Visina Height	Dužina Length	Pakovanje Pack kom piece	Šifra artikla Article
	mm	mm		PL
P PNK 110 PL	110	3000	50	10030255
				TC
P PNK 110 TC	110	3000	50	10020281

PL Pocinkovani lim / Galvanized sheet

TC Toplo pocinkovano potapanjem / Hot - dip galvanized

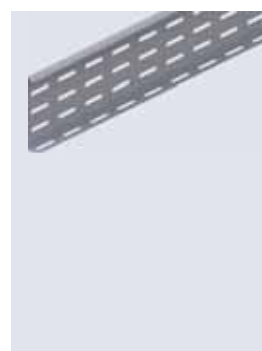

Kuka regala za MNK / Mesh cable trays hook

MNK

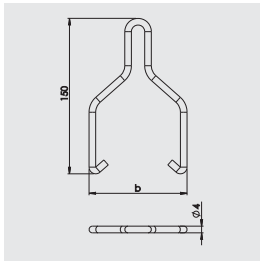

Tip Typ	Visina Height	Šifra artikla Article
K LCT 50	mm 150	60010016



Connecting Mesh Cable Tray



Mrežasti nosači kablova



H50

H60

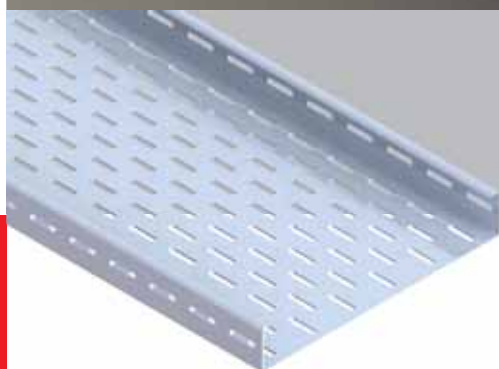

E90

5

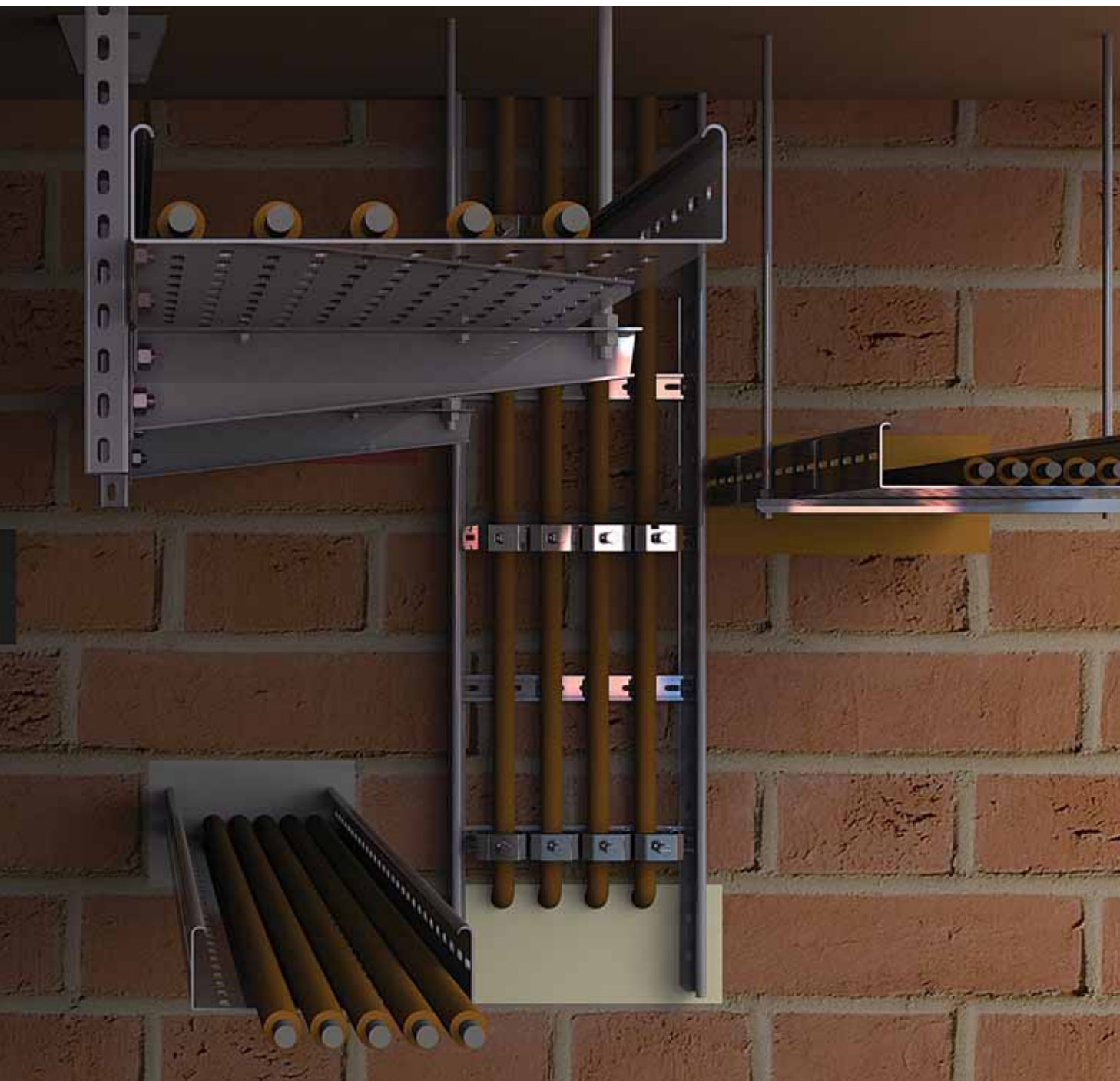

E90 - VATROOTPORNI NOSAČI KABLOVA

E90 - FIREPROOF CABLE TRAY SYSTEMS



Princip montaže na dve navojne šipke. Za primenu ove montaže koristi se profilna šina tipa E90, dve navojne šipke.

The principle of installation the rack on two threaded rods. We use profile ray type E90 and two threaded rods to apply this type of assembly.



Princip kačenja regala E 90 na zid i na plafon. Za primenu ove montaže koristi se konzola tipa E90, i navojna šipka.

The principle of hanging the rack on the wall and the ceilings. We use the E90 type of the cantilever and the threaded rod to apply this type of assembly.



Princip montaže na zid konzolom i ugaonim nosačem. Za primenu ovog načina montaže koristi se konzola tipa E90, dva kosa nosača tipa E90, navojna šipka.

The principle of installation the rack on the wall by using the cantilever and the angular carrier. We use the E90 type of the cantilever, two carriers under the slope and a threaded rod to apply this type of assembly.



Princip kačenja regala E 90 na plafon U nosačem i navojnom šipkom. Za primenu ove montaže koristi se UD nosač tipa E90, U nosač tipa E90, konzola tipa E90, navojna šipka.

The principle of installation the rack E90 on the ceilings by U shape carrier and a threaded rod. We use the UD carrier, type E90, U shape carrier, E90 type of the cantilever and a threaded rod to apply this type of assembly.

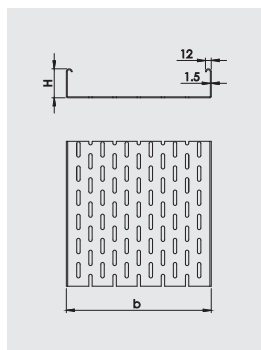

Perforirani nosač kablova tipa E90 H 50mm / Perforated cable trays, type E90 H 50mm

E90

Tip Typ	Širina b Width b	Visina H Height H	Debljina Thickness	Dužina Length	Korisni presek Useful section	Šifra artikla Article
	mm	mm	mm	mm	cm ²	
PNK 5 10 200 E90	100	50	1.5	2000	48	40010000
PNK 5 20 200 E90	200	50	1.5	2000	98	40010001
PNK 5 30 200 E90	300	50	1.5	2000	148	40010002
PNK 5 40 200 E90	400	50	1.5	2000	198	40010003
PNK 5 5 300 E90	50	50	1.5	3000	23	40010004
PNK 5 10 300 E90	100	50	1.5	3000	48	40010005
PNK 5 20 300 E90	200	50	1.5	3000	98	40010006
PNK 5 30 300 E90	300	50	1.5	3000	148	40010007
PNK 5 40 300 E90	400	50	1.5	3000	198	40010008



Lestvičasti nosač kablova tipa E90 H 50mm / Ladder cable trays, type E90 H 50mm

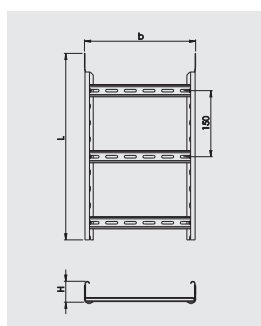

Tip Typ	Širina b Width b	Visina H Height H	Debljina Thickness	Dužina Length	Korisni presek Useful section	Šifra artikla Article
	mm	mm	mm	mm	cm ²	
LNK 5 10 200 E90	100	50	1.5	2000	48	40020000
LNK 5 20 200 E90	200	50	1.5	2000	98	40020001
LNK 5 30 200 E90	300	50	1.5	2000	148	40020002
LNK 5 40 200 E90	400	50	1.5	2000	198	40020003
LNK 5 10 300 E90	100	50	1.5	3000	48	40020004
LNK 5 20 300 E90	200	50	1.5	3000	98	40020005
LNK 5 30 300 E90	300	50	1.5	3000	148	40020006
LNK 5 40 300 E90	400	50	1.5	3000	198	40020007



Spojnica lestvičastog nosača kablova tipa E90 H 50mm / Coupling ladder cable trays, type E90 H 50mm

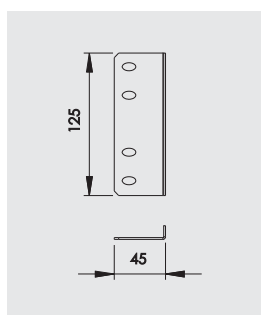

Tip Typ	Visina Height	Pakovanje Pack kom piece	Šifra artikla Article
	mm		
S LNK 50 E90	50	10	40020008



E90 - Vatrootporni nosači

Perforirani nosač kablova tipa E90 H 60mm / Perforated cable trays, type E90 H 60mm

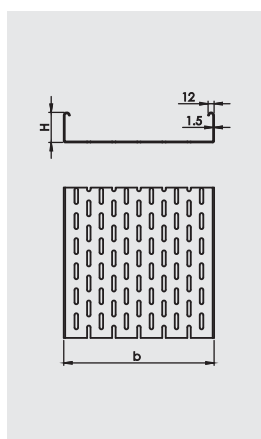

Tip Typ	Širina b Width b	Visina H Height H	Debljina Thickness	Dužina Length	Korisni presek Useful section	Šifra artikla Article
	mm	mm	mm	mm	cm ²	
PNK 6 10 200 E90	100	60	1.5	2000	58	40010009
PNK 6 20 200 E90	200	60	1.5	2000	118	40010010
PNK 6 30 200 E90	300	60	1.5	2000	178	40010011
PNK 6 40 200 E90	400	60	1.5	2000	238	40010012
PNK 6 50 200 E90	500	60	1.5	2000	298	40010013
PNK 6 60 200 E90	600	60	1.5	2000	358	40010014
PNK 6 5 300 E90	60	50	1.5	3000	28	40010015
PNK 6 10 300 E90	100	60	1.5	3000	58	40010016
PNK 6 20 300 E90	200	60	1.5	3000	118	40010017
PNK 6 30 300 E90	300	60	1.5	3000	178	40010018
PNK 6 40 300 E90	400	60	1.5	3000	238	40010019
PNK 6 50 300 E90	500	60	1.5	3000	298	40010020
PNK 6 60 300 E90	600	60	1.5	3000	358	40010021



Lestvičasti nosač kablova tipa E90 H 60mm / Ladder cable trays, type E90 H 60mm

E90

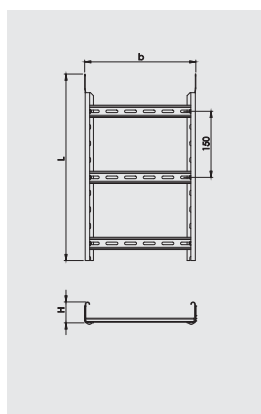

Tip Typ	Širina b Width b	Visina H Height H	Debljina Thickness	Dužina Length	Korisni presek Useful section	Šifra artikla Article
	mm	mm	mm	mm	cm ²	
LNK 6 10 200 E90	100	60	1.5	2000	58	40020009
LNK 6 20 200 E90	200	60	1.5	2000	118	40020010
LNK 6 30 200 E90	300	60	1.5	2000	178	40020011
LNK 6 40 200 E90	400	60	1.5	2000	238	40020012
LNK 6 50 200 E90	500	60	1.5	2000	298	40020013
LNK 6 60 200 E90	600	60	1.5	2000	358	40020014
LNK 6 10 300 E90	100	60	1.5	3000	58	40020015
LNK 6 20 300 E90	200	60	1.5	3000	118	40020016
LNK 6 30 300 E90	300	60	1.5	3000	178	40020017
LNK 6 40 300 E90	400	60	1.5	3000	238	40020018
LNK 6 50 300 E90	500	60	1.5	3000	298	40020019
LNK 6 60 300 E90	600	60	1.5	3000	358	40020020



Spojnica lestvičastog nosača kablova tipa E90 H 60mm / Coupling ladder cable trays, type E90 H 60mm

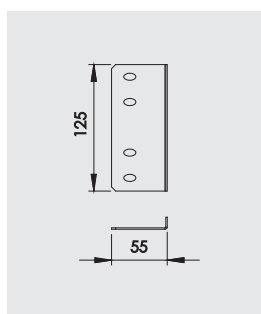

Tip Typ	Visina Height	Pakovanje Pack	Šifra artikla Article
	mm	kom piece	
S LNK 60 E90	60	10	40020021



Kosi nosač tipa E90 / Bevel carrier, type E90

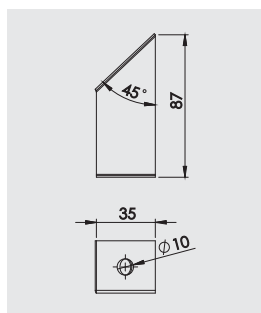

Tip Typ	Debljina Thickness	Pakovanje Pack	Šifra artikla Article
	mm	kom piece	
KS E90	2	10	40030000

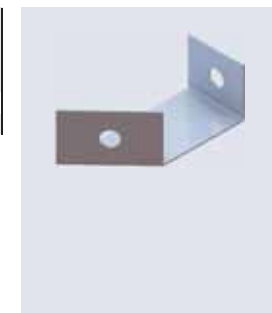

Zidna i konzola nosača tipa E90 / Wall cantilever carrier, type E90

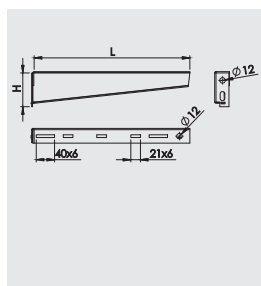

Tip Typ	Debljina Thickness	Dužina Length	Pakovanje Pack	Šifra artikla Article
	mm	mm	kom piece	
KZ PNK 50 E90	2	80	10	40030001
KZ PNK 100 E90	2	130	10	40030002
KZ PNK 160 E90	2	190	10	40030003
KZ PNK 200 E90	2	230	10	40030004
KZ PNK 300 E90	2	330	10	40030005
KZ PNK 400 E90	2	430	10	40030006
KZ PNK 500 E90	2	530	10	40030007
KZ PNK 600 E90	2	630	10	40030008

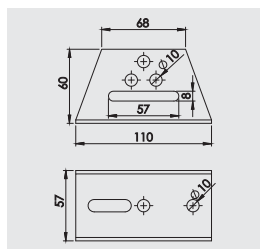

UD nosač tipa E90 / UD carrier, type E90

E90

Tip Typ	Debljina Thickness	Pakovanje Pack kom piece	Šifra artikla Article
UD U5 E90	mm 2	10	40030009



Plafonski U nosač tipa E90 / Ceiling U carrier, type E90

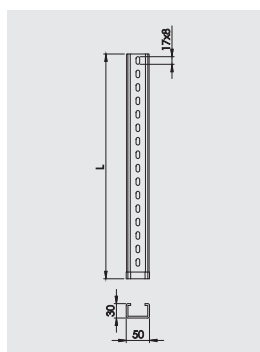

Tip Typ	Debljina Thickness	Dužina Length	Pakovanje Pack kom piece	Šifra artikla Article
U 5 20 E90	2	200	1	40030010
U 5 30 E90	2	300	1	40030011
U 5 40 E90	2	400	1	40030012
U 5 50 E90	2	500	1	40030013
U 5 60 E90	2	600	1	40030014
U 5 70 E90	2	700	1	40030015
U 5 80 E90	2	800	1	40030016
U 5 90 E90	2	900	1	40030017
U 5 100 E90	2	1000	1	40030018
U 5 150 E90	2	1500	1	40030019
U 5 200 E90	2	2000	1	40030020



Odstojnik tipa E90 / Spacer, type E90

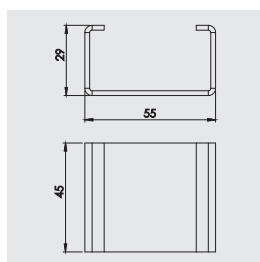

Tip Typ	Debljina Thickness	Pakovanje Pack kom piece	Šifra artikla Article
OD U5 E90	mm 2	10	40030021



Profilna perforirana šina tipa E90 / Profile perforated track, type E90

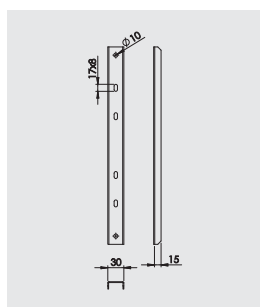

Tip Typ	Dimenzije Dimension s	Debljina Thickness	Dužina Length	Pakovanje Pack kom piece	Šifra artikla Article
PS L 2M E90	30x15	2	2000	10	40030022
PS L 14 E90	30x15	2	140	10	40030023
PS L 20 E90	30x15	2	200	10	40030024
PS L 24 E90	30x15	2	240	10	40030025
PS L 34 E90	30x15	2	340	10	40030026
PS L 44 E90	30x15	2	440	10	40030027
PS L 54 E90	30x15	2	540	10	40030028
PS L 64 E90	30x15	2	640	10	40030029



Spojnica PNK nosača E90 / Connector PNK cable tray E90

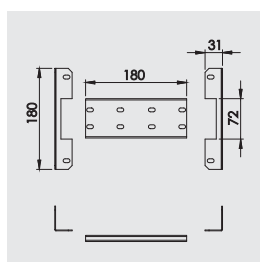

Tip Typ	Širina b Width b	Debljina Thickness	Pakovanje Pack kom piece	Šifra artikla Article
S PNK 50 E90	50	1.5	10	40030030
S PNK 100 E90	100	1.5	10	40030031
S PNK 200 E90	200	1.5	10	40030032
S PNK 300 E90	300	1.5	10	40030033
S PNK 400 E90	400	1.5	10	40030034
S PNK 500 E90	500	1.5	10	40030035
S PNK 600 E90	600	1.5	10	40030036



E90 - Vatrootporni nosači

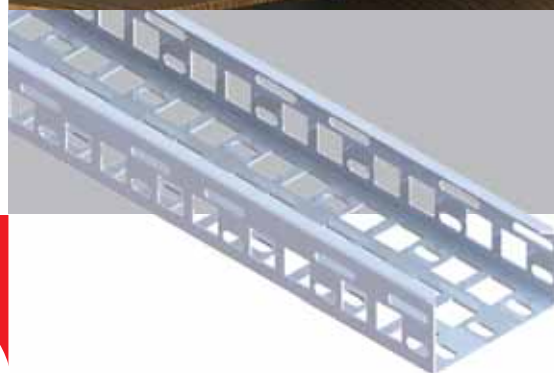

NZR

6



NOSAČI KABLOVA ZA RASVETU

CABLE TRAY SYSTEMS FOR LIGHTING



1

Zalamajuća spojnica koristi se za izradu ugaonih krivina na licu mesta, a veza između spojnica i regala za rasvetu ostvarena je torban vijcima tipa PEKOM M6 x 12.

Angle connector is used for making angle curves when montage, and the connection between connectors and cable carriers for the lightening is formed by PEKOM carriage bolts M6x12.



2

Za montažu regala za rasvetu na plafon gde je predviđena veća visina spuštanja koristi se lanac ili sajla koja se za regal kači žičanom kukom tipa PEKOM.

We use chain or cable, hooked to the cable carrier by wired hook, for mounting cable carriers for the lightening on the ceilings, where a higher level of descent is foreseen.



3

Montaža regala za rasvetu na trapezni plafon ostvaruje se pomoću nosača za trapezni lim, navojne šipke i nosača regala.

We use brackets for trapezoidal sheet metal, threaded root and cable carrier for mounting cable carriers for the lightening against the trapezoidal ceiling.

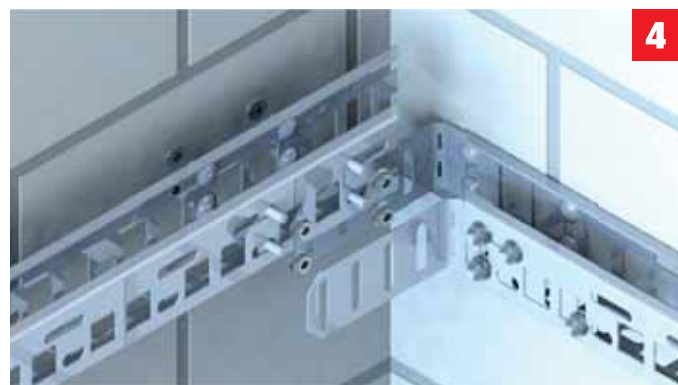

4

Zalamajuća spojnica koristi se za izradu ugaonih krivina na licu mesta, a ugao se formira sečenjem krajeva regala.

Angle connector is used for making angle curves when montage, and we make an angle by cutting the ends of the cable carriers.

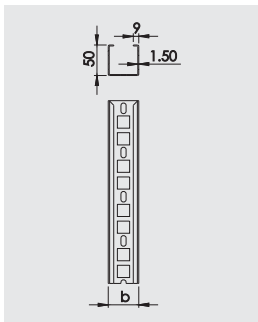
Regal za rasvetu b 50mm / Lighting carrier systems b 50mm
NZR

Tip Typ	Širina b Width b	Visina Height	Debljina Thickness	Dužina Length	Šifra artikla Article
LCT 5 5 300 PL	mm	50	mm	3000	PL 60010001

PL Pocinkovani lim / Galvanized sheet

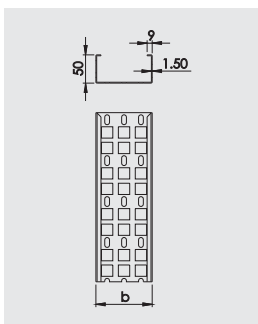
Regal za rasvetu b 100mm / Lighting carrier systems b 100mm

Tip Typ	Širina b Width b	Visina Height	Debljina Thickness	Dužina Length	Šifra artikla Article
LCT 5 10 300 PL	mm	100	mm	3000	PL 60010002

PL Pocinkovani lim / Galvanized sheet

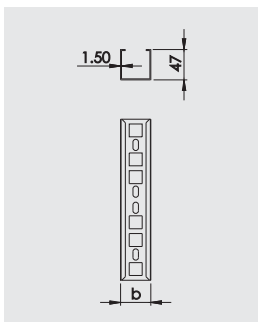
Spojnica regala za rasvetu b 50 / Coupling for lighting carrier systems b 50

Tip Typ	Debljina Thickness	Šifra artikla Article
S LCT 5 5 PL	mm	PL 60010003

PL Pocinkovani lim / Galvanized sheet

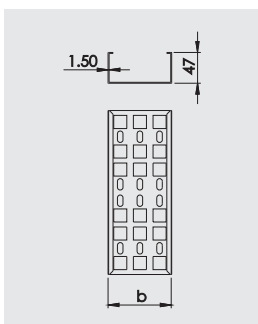
Spojnica regala za rasvetu b 100 / Coupling for lighting carrier systems b 100

Tip Typ	Debljina Thickness	Šifra artikla Article
S LCT 5 10 PL	mm	PL 60010004

PL Pocinkovani lim / Galvanized sheet



Nosач - Poklopac / Carrier - Lid

NZR

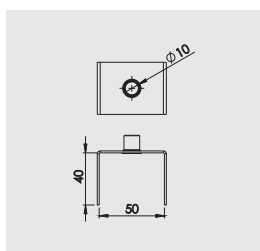

Tip Typ	Širina b Width b	Visina Height	Šifra artikla Article
N-P LCT 50	50	40	60010005
N-P LCT 100	100	40	60010006

PL Pocinkovani lim / Galvanized sheet



Regal za rasvetu debljine 0.75mm / Lighting carrier system thickness 0.75mm

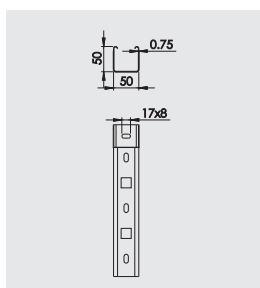

Tip Typ	Debljina Thickness	Šifra artikla Article
P.PNK LCT	0.75	PL 60010007

PL Pocinkovani lim / Galvanized sheet



Lomljiva spojnica regala za rasvetu / Angle connector for lighting carrier system

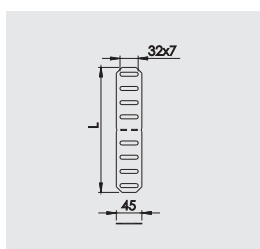

Tip Typ	Debljina Thickness	Šifra artikla Article
LS LCT	1.5	PL 60010008

PL Pocinkovani lim / Galvanized sheet

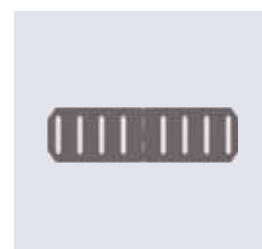

Zglobno rotirajuća spojnica regala za rasvetu / Adjustable connector for lighting carrier system

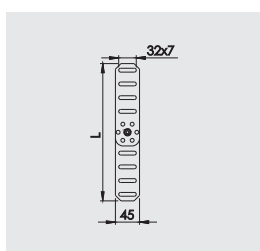

Tip Typ	Debljina Thickness	Šifra artikla Article
ZS LCT	1.5	PL 60010009

PL Pocinkovani lim / Galvanized sheet



Nosач za trapezni lim / Carrier for trapezoidal sheet

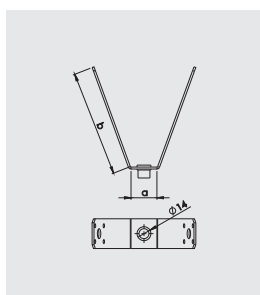

Tip Typ	Debljina Thickness	Centralni otvor Hole	Pakovanje Pack kom piece	Šifra artikla Article
TL 8 PL	2	M8	10	PL 30010034
TL 10 PL	2	M10	10	30010027
TL 8 TC	2	M8	10	TC 30020034
TL 10 TC	2	M10	10	30020027

PL Pocinkovani lim / Galvanized sheet **TC** Toplo pocinkovano potapanjem / Hot - dip galvanized

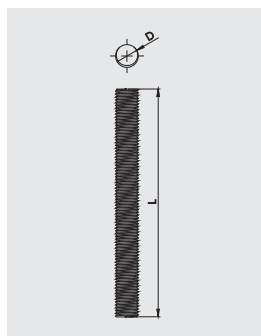

Navojna šipka / Threaded rod

NZR

Tip Typ	Dužina Length	Prečnik Diameter	Pakovanje Pack kom piece	Šifra artikla Article
Navojna šipka M8	3000	8	10	60010010
Navojna šipka M10	3000	10	10	60010011



MUF / Muff with transverse inner thread

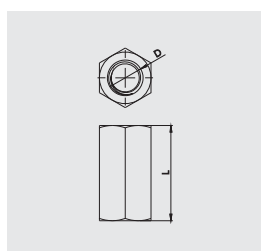

Tip Typ	Prečnik Diameter	Pakovanje Pack kom piece	Šifra artikla Article
Muf M8	8	10	60010012
Muf M10	10	10	60010013



Vijak za trapezni lim / Screw for trapezoidal sheet

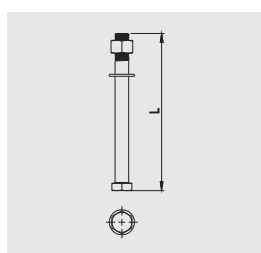

Tip Typ	Dužina Length	Prečnik Diameter	Pakovanje Pack kom piece	Šifra artikla Article
Vijak za TR lim M10	110	10	10	60010014



Stezaljka čeličnog užeta / Steel clamp squiser

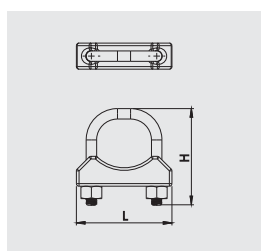

Tip Typ	Pakovanje Pack kom piece	Šifra artikla Article
Stezaljka užeta	10	60010015



Nosaci kablova za rasvetu

Perforirana traka / Perforated strip

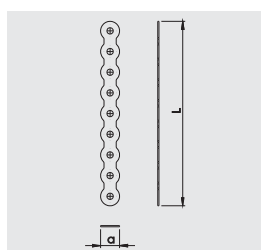

Tip Typ	Dužina L Length L	Širina Width	Otvor Diameter	Pakovanje Pack kom piece	Šifra artikla Article
PTR L 3M PL 6.2	3000	18	6.2	10	30010056
PTR L 3M PL 8.2	3000	18	8.2	10	30010063

PL Pocinkovani lim / Galvanized sheet

Kuka regala za rasvetu / Hook for lighting carrier system

NZR

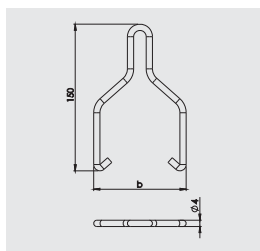

Tip Typ	Dužina L Length L	Debljina Thickness	Pakovanje Pack kom piece	Šifra artikla Article
Kuka LCT	150	mm 4	10	PL 60010016



Lanac regala za rasvetu / Chain for lighting carrier system

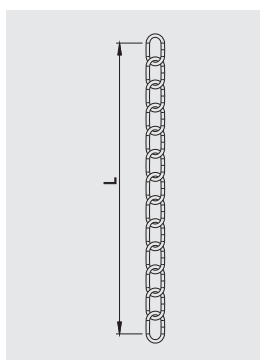

Tip Typ	Pakovanje Pack kom piece	Šifra artikla Article
Lanac LCT	10	PL 60010017

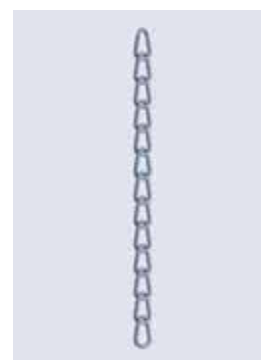

Naprstak / Stainless steel thimble

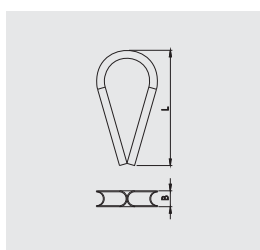

Tip Typ	Pakovanje Pack kom piece	Šifra artikla Article
Naprstak LCT	10	PL 60010018



Čelično uže / Steel cable

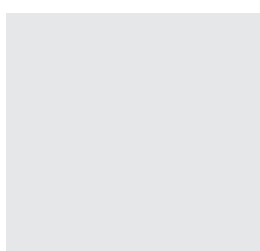

Tip Typ	Pakovanje Pack kom piece	Šifra artikla Article
Čelično uže	10	PL 60010019

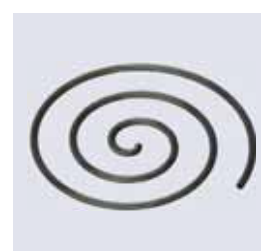

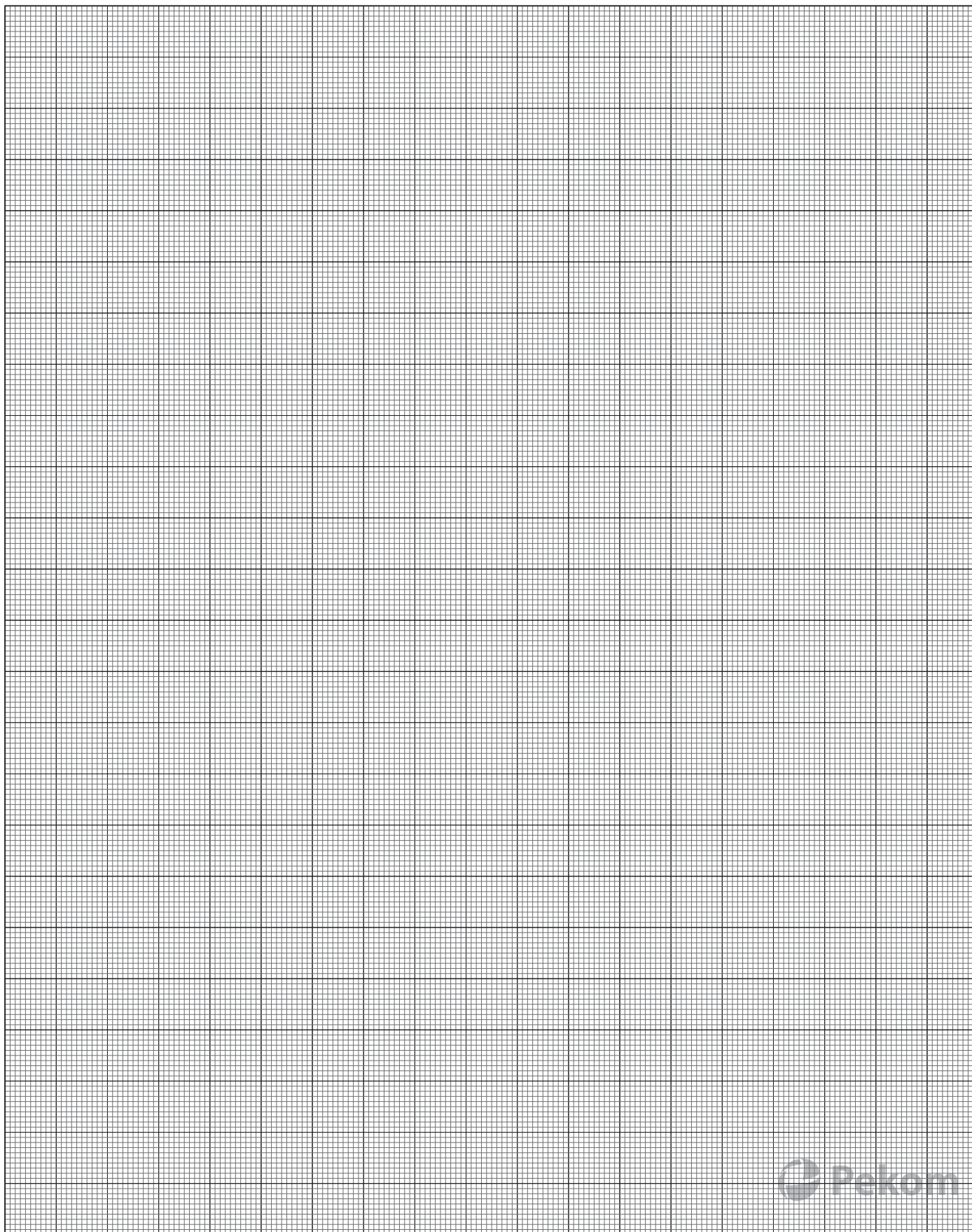

V2A

V4A



INOX

7



NOSAČI KABLOVA OD INOX-A

STAINLESS STEEL CABLE TRAY SYSTEMS

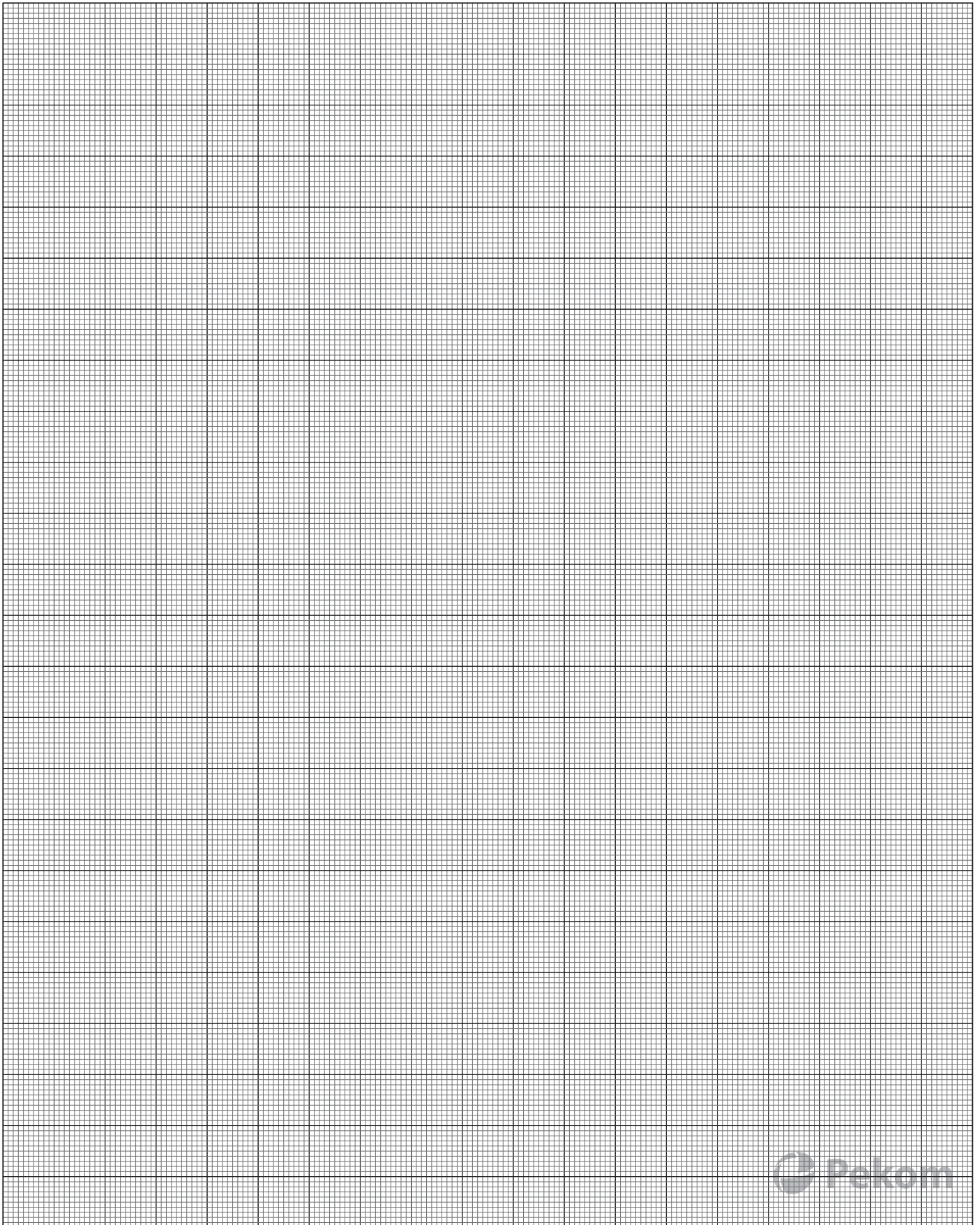

Plafonski UD nosač INOX / Ceiling UD carrier INOX

INOX

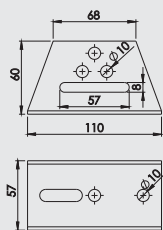

Tip Typ	Debljina Thickness	Nosivost Load	Pakovanje Pack kom piece	Šifra artikla Article
UD U5 V2A	2 mm	611 kg	10	V2A 10060086
UD U5 V4A	2 mm	611 kg	10	V4A 10090086

V2A INOX 1.4301

V4A INOX 1.4571



U profil INOX / U profile INOX

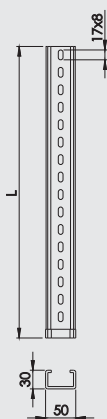

Tip Typ	Dužina L Length L	Dimenzije Dimensions	Debljina Thickness	Pakovanje Pack kom piece	Šifra artikla Article
U 5 20 V2A	200	50x30	2	10	V2A 10060087
U 5 30 V2A	300	50x30	2	10	10060088
U 5 40 V2A	400	50x30	2	10	10060089
U 5 50 V2A	500	50x30	2	10	10060090
U 5 60 V2A	600	50x30	2	6	10060091
U 5 70 V2A	700	50x30	2	6	10060092
U 5 80 V2A	800	50x30	2	6	10060093
U 5 90 V2A	900	50x30	2	6	10060094
U 5 100 V2A	1000	50x30	2	4	10060095
U 5 150 V2A	1500	50x30	2	4	10060096
U 5 200 V2A	2000	50x30	2	4	10060097
U 5 300 V2A	3000	50x30	2	4	10060098
U 5 20 V4A	200	50x30	2	10	V4A 10090087
U 5 30 V4A	300	50x30	2	10	10090088
U 5 40 V4A	400	50x30	2	10	10090089
U 5 50 V4A	500	50x30	2	10	10090090
U 5 60 V4A	600	50x30	2	6	10090091
U 5 70 V4A	700	50x30	2	6	10090092
U 5 80 V4A	800	50x30	2	6	10090093
U 5 90 V4A	900	50x30	2	6	10090094
U 5 100 V4A	1000	50x30	2	4	10090095
U 5 150 V4A	1500	50x30	2	4	10090096
U 5 200 V4A	2000	50x30	2	4	10090097
U 5 300 V4A	3000	50x30	2	4	10090098

V2A INOX 1.4301

V4A INOX 1.4571

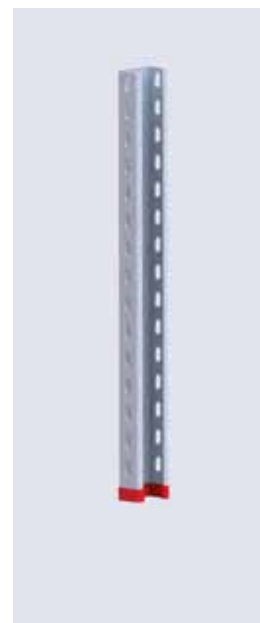

Spojница U stuba INOX / Clip U pillar INOX



Tip Typ	Dužina L Length L	Debljina Thickness	Pakovanje Pack kom piece	Šifra artikla Article
S U5 V2A	200	2 mm	10	V2A 10060099
S U5 V4A	200	2 mm	10	V4A 10090099

V2A INOX 1.4301

V4A INOX 1.4571



Odstojnik za U stub INOX / Spacer for U pillar INOX

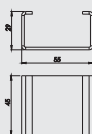

Tip Typ	Debljina Thickness	Pakovanje Pack kom piece	Šifra artikla Article
OD U5 V2A	2 mm	10	V2A 10060100
OD U5 V4A	2 mm	10	V4A 10090100

V2A INOX 1.4301

V4A INOX 1.4571



Nosači kablova od Inox-a

Konzola INOX / Cantilever INOX

INOX

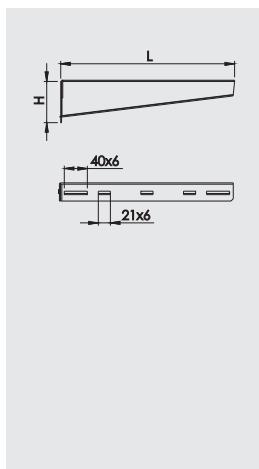

Tip Typ	Dužina Length L mm	Visina Height H mm	Debljina Thickness D mm	Nosivost Load kg	Pakovanje Pack kom piece	Šifra artikla Article
KZ PNK 50 V2A	50	60	2	129	10	V2A 10060101
KZ PNK 100 V2A	100	60	2	130	10	10060102
KZ PNK 160 V2A	160	60	2	131	10	10060103
KZ PNK 200 V2A	200	60	2	132	10	10060104
KZ PNK 300 V2A	300	60	2	128	10	10060105
KZ PNK 400 V2A	400	60	2	126	10	10060106
KZ PNK 500 V2A	500	93	2	121	10	10060107
KZ PNK 600 V2A	600	93	2	118	10	10060108
V4A						
KZ PNK 50 V4A	50	60	2	129	10	10090101
KZ PNK 100 V4A	100	60	2	130	10	10090102
KZ PNK 160 V4A	160	60	2	131	10	10090103
KZ PNK 200 V4A	200	60	2	132	10	10090104
KZ PNK 300 V4A	300	60	2	128	10	10090105
KZ PNK 400 V4A	400	60	2	126	10	10090106
KZ PNK 500 V4A	500	93	2	121	10	10090107
KZ PNK 600 V4A	600	93	2	118	10	10090108

V2A INOX 1.4301

V4A INOX 1.4571



Nosач za trapezni lim INOX / Carrier for trapezoidal sheet INOX

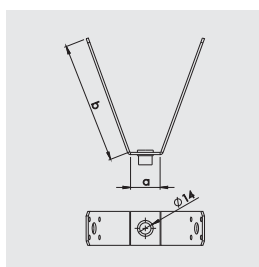

Tip Typ	Debljina Thickness mm	Centralni otvor Hole mm	Pakovanje Pack kom piece	Šifra artikla Article
TL 8 V2A	2	M8	10	V2A 10060109
TL 10 V2A	2	M10	10	10060110
TL 8 V4A	2	M8	10	V4A 10090109
TL 10 V4A	2	M10	10	10090110

V2A INOX 1.4301

V4A INOX 1.4571



Plafonski G nosač INOX / Ceiling G carrier INOX

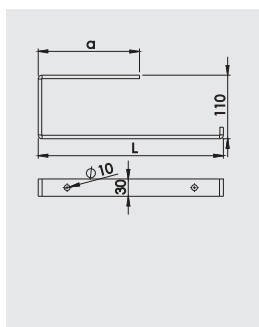

Tip Typ	Dužina L Length L mm	Otvor Hole mm	Debljina Thickness mm	Nosivost Load kg	Pakovanje Pack kom piece	Šifra artikla Article
G PNK 100 V2A	100	10	6	78	10	V2A 10060111
G PNK 160 V2A	160	10	6	67	10	10060112
G PNK 200 V2A	200	10	6	63	10	10060113
G PNK 300 V2A	300	10	6	40	10	10060114
G PNK 100 V4A	100	10	6	78	10	V4A 10090111
G PNK 160 V4A	160	10	6	67	10	10090112
G PNK 200 V4A	200	10	6	63	10	10090113
G PNK 300 V4A	300	10	6	40	10	10090114

V2A INOX 1.4301

V4A INOX 1.4571



C nosač INOX / C carrier INOX

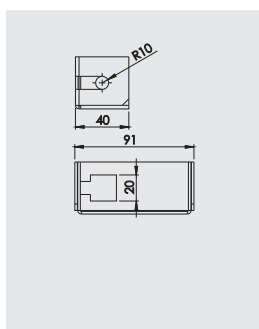

Tip Typ	Debljina Thickness mm	Pakovanje Pack kom piece	Šifra artikla Article
CN V2A	2	10	V2A 10060115
CN V4A	2	10	V4A 10090115

V2A INOX 1.4301

V4A INOX 1.4571

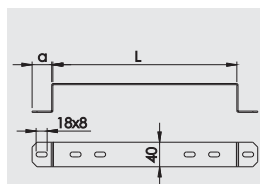

Odstojnik INOX / Spacer INOX

INOX

Tip Typ	Dužina L Length L	Pakovanje Pack kom piece	Šifra artikla Article
	mm		V2A
OD 10 V2A	100	10	10060116
OD 16 V2A	160	10	10060117
OD 20 V2A	200	10	10060118
OD 30 V2A	300	10	10060119
OD 40 V2A	400	10	10060120
OD 50 V2A	500	10	10060121
OD 60 V2A	600	10	10060122
			V4A
OD 10 V4A	100	10	10090116
OD 16 V4A	160	10	10090117
OD 20 V4A	200	10	10090118
OD 30 V4A	300	10	10090119
OD 40 V4A	400	10	10090120
OD 50 V4A	500	10	10090121
OD 60 V4A	600	10	10090122

V2A INOX 1.4301

V4A INOX 1.4571

Središnji nosač INOX / Central carrier INOX

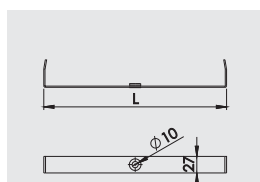

Tip Typ	Dužina L Length L	Debljina Thickness	Centralni otvor Hole	Pakovanje Pack kom piece	Šifra artikla Article
	mm	mm	mm		V2A
SN 10 M8 V2A	94	3	M8	10	10060123
SN 16 M8 V2A	154	3	M8	10	10060124
SN 20 M8 V2A	195	3	M8	10	10060125
SN 30 M8 V2A	295	3	M8	10	10060126
SN 10 M10 V2A	94	3	M10	10	10060127
SN 16 M10 V2A	154	3	M10	10	10060128
SN 20 M10 V2A	195	3	M10	10	10060129
SN 30 M10 V2A	295	3	M10	10	10060130
					V4A
SN 10 M8 V4A	94	3	M8	10	10090123
SN 16 M8 V4A	154	3	M8	10	10090124
SN 20 M8 V4A	195	3	M8	10	10090125
SN 30 M8 V4A	295	3	M8	10	10090126
SN 10 M10 V4A	94	3	M10	10	10090127
SN 16 M10 V4A	154	3	M10	10	10090128
SN 20 M10 V4A	195	3	M10	10	10090129
SN 30 M10 V4A	295	3	M10	10	10090130

V2A INOX 1.4301

V4A INOX 1.4571

Perforirana šina sa jednom navojnom šipkom INOX/ Perforated track with one threaded rod INOX

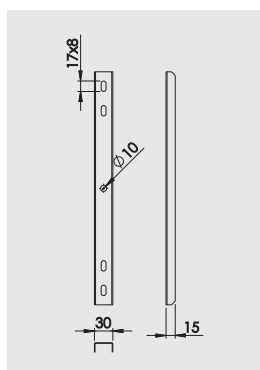

Tip Typ	Dužina L Length L	Dimenzije Dimensions	Debljina Thickness	Pakovanje Pack kom piece	Šifra artikla Article
	mm	mm	mm		V2A
PS L 05 V2A	50	30x15	2	10	10060131
PS L 10 V2A	100	30x15	2	10	10060132
PS L 16 V2A	160	30x15	2	10	10060133
PS L 20 V2A	200	30x15	2	10	10060134
PS L 30 V2A	300	30x15	2	10	10060135
					V4A
PS L 05 V4A	50	30x15	2	10	10090131
PS L 10 V4A	100	30x15	2	10	10090132
PS L 16 V4A	160	30x15	2	10	10090133
PS L 20 V4A	200	30x15	2	10	10090134
PS L 30 V4A	300	30x15	2	10	10090135

V2A INOX 1.4301

V4A INOX 1.4571

Nosaci kablova od Inox-a

Perforirana šina sa dve navojne šipke INOX / Perforated track with two threaded rod INOX

INOX



Tip Typ	Dužina L Length L	Dimenzije Dimensions	Debljina Thickness	Pakovanje Pack kom piece	Šifra artikla Article
	mm	mm	mm		V2A
PS L 2M 15 V2A	2000	30x15	1,5	10	10060136
PS L 2M 20 V2A	2000	30x15	2	10	10060137
PS L 13 V2A	130	30x15	2	10	10060138
PS L 18 V2A	180	30x15	2	10	10060139
PS L 24 V2A	240	30x15	2	10	10060140
PS L 28 V2A	280	30x15	2	10	10060141
PS L 38 V2A	380	30x15	2	10	10060142
PS L 48 V2A	480	30x15	2	10	10060143
PS L 58 V2A	580	30x15	2	10	10060144
PS L 68 V2A	680	30x15	2	10	10060145
					V4A
PS L 2M 15 V4A	2000	30x15	1,5	10	10090136
PS L 2M 20 V4A	2000	30x15	2	10	10090137
PS L 13 V4A	130	30x15	2	10	10090138
PS L 18 V4A	180	30x15	2	10	10090139
PS L 24 V4A	240	30x15	2	10	10090140
PS L 28 V4A	280	30x15	2	10	10090141
PS L 38 V4A	380	30x15	2	10	10090142
PS L 48 V4A	480	30x15	2	10	10090143
PS L 58 V4A	580	30x15	2	10	10090144
PS L 68 V4A	680	30x15	2	10	10090145

V2A INOX 1.4301

V4A INOX 1.4571

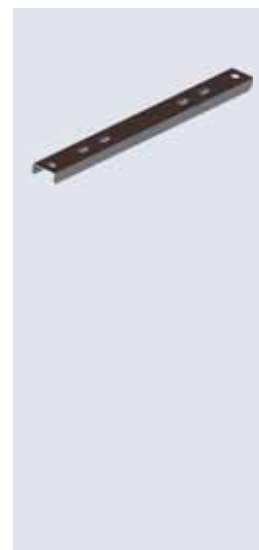

Perforirani L profil INOX / Perforated L Profile INOX

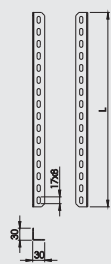

Tip Typ	Dužina L Length L	Dimenzije Dimensions	Debljina Thickness	Pakovanje Pack kom piece	Šifra artikla Article
	mm	mm	mm		V2A
UP L 2M V2A	2000	30x30	2	10	10060146
					V4A
UP L 2M V4A	2000	30x30	2	10	10090146

V2A INOX 1.4301

V4A INOX 1.4571

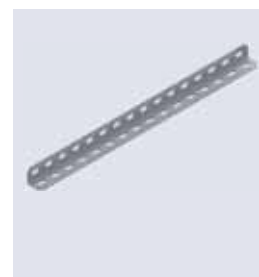

Perforirana traka INOX / Perforated strip INOX

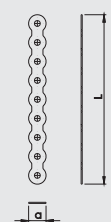

Tip Typ	Dužina L Length L	Širina Width	Otvor Diameter	Pakovanje Pack kom piece	Šifra artikla Article
	mm	mm	mm		V2A
PTR L 3M 6.2 V2A	3000	18	6.2	10	10060147
PTR L 3M 8.2 V2A	3000	18	8.2	10	10060148
					V4A
PTR L 3M 6.2 V4A	3000	18	6.2	10	10090147
PTR L 3M 8.2 V4A	3000	18	8.2	10	10090148

V2A INOX 1.4301

V4A INOX 1.4571



Perforirana traka velike nosivosti INOX / Perforated strip large capacity INOX

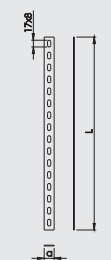

Tip Typ	Dužina L Length L	Širina Width	Debljina Thickness	Pakovanje Pack kom piece	Šifra artikla Article
	mm	mm	mm		V2A
PTR L 2M V2A	2000	25	2	10	10060149
					V4A
PTR L 2M V4A	2000	25	2	10	10090149

V2A INOX 1.4301

V4A INOX 1.4571

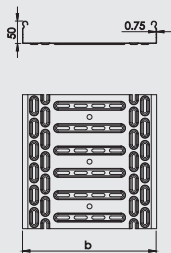

Nosač kablova PNK H 50mm INOX / PNK cable trays H 50mm INOX

INOX

Tip Typ	Širina Width mm	Visina Height mm	Debljina Thickness mm	Dužina Length mm	Korisni presek Useful section cm ²	Dozvoljeno opterećenje Allowed load			Šifra artikla Article V2A
						1,5 m kg/m	2,0 m kg/m	2,5 m	
PNK 5 5 300 V2A	50	50	0,75	3000	23	123	78	44	10060001
PNK 5 10 300 V2A	100	50	0,75	3000	48	121	80	50	10060002
PNK 5 16 300 V2A	160	50	0,75	3000	78	128	81	48	10060003
PNK 5 20 300 V2A	200	50	0,75	3000	98	132	77	47	10060004
PNK 5 30 300 V2A	300	50	0,75	3000	148	112	78	42	10060005
PNK 5 40 300 V2A	400	50	1	3000	198	153	123	69	10060006
PNK 5 50 300 V2A	500	50	1	3000	248	156	125	62	10060007
PNK 5 60 300 V2A	600	50	1	3000	298	158	128	62	10060008
V4A									
PNK 5 5 300 V4A	50	50	0,75	3000	23	123	78	44	10090001
PNK 5 10 300 V4A	100	50	0,75	3000	48	121	80	50	10090002
PNK 5 16 300 V4A	160	50	0,75	3000	78	128	81	48	10090003
PNK 5 20 300 V4A	200	50	0,75	3000	98	132	77	47	10090004
PNK 5 30 300 V4A	300	50	0,75	3000	148	112	78	42	10090005
PNK 5 40 300 V4A	400	50	1	3000	198	153	123	69	10090006
PNK 5 50 300 V4A	500	50	1	3000	248	156	125	62	10090007
PNK 5 60 300 V4A	600	50	1	3000	298	158	128	62	10090008

V2A INOX 1.4301

V4A INOX 1.4571



Nosač kablova PNK H 50mm L=2500mm INOX / PNK cable trays H 50mm L=2500mm INOX

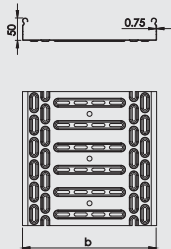

Tip Typ	Širina Width mm	Visina Height mm	Debljina Thickness mm	Dužina Length mm	Korisni presek Useful section cm ²	Dozvoljeno opterećenje Allowed load			Šifra artikla Article V2A
						1,5 m kg/m	2,0 m kg/m	2,5 m	
PNK 5 5 250 V2A	50	50	0,75	2500	23	123	78	44	10060243
PNK 5 10 250 V2A	100	50	0,75	2500	48	121	80	50	10060244
PNK 5 16 250 V2A	160	50	0,75	2500	78	128	81	48	10060245
PNK 5 20 250 V2A	200	50	0,75	2500	98	132	77	47	10060246
PNK 5 30 250 V2A	300	50	0,75	2500	148	112	78	42	10060247
PNK 5 40 250 V2A	400	50	1	2500	198	153	123	69	10060248
PNK 5 50 250 V2A	500	50	1	2500	248	156	125	62	10060249
PNK 5 60 250 V2A	600	50	1	2500	298	158	128	62	10060250
V4A									
PNK 5 5 250 V4A	50	50	0,75	2500	23	123	78	44	10090243
PNK 5 10 250 V4A	100	50	0,75	2500	48	121	80	50	10090244
PNK 5 16 250 V4A	160	50	0,75	2500	78	128	81	48	10090245
PNK 5 20 250 V4A	200	50	0,75	2500	98	132	77	47	10090246
PNK 5 30 250 V4A	300	50	0,75	2500	148	112	78	42	10090247
PNK 5 40 250 V4A	400	50	1	2500	198	153	123	69	10090248
PNK 5 50 250 V4A	500	50	1	2500	248	156	125	62	10090249
PNK 5 60 250 V4A	600	50	1	2500	298	158	128	62	10090250

V2A INOX 1.4301

V4A INOX 1.4571



Poklopac regala PNK L=2500mm INOX / Cable tray cover L=2500mm INOX



Tip Typ	Širina Width mm	Debljina Thickness mm	Dužina Length mm	Šifra artikla Article V2A
PC PNK 50/2500 V2A	50	0,75	2500	10060259
PC PNK 100/2500 V2A	100	0,75	2500	10060260
PC PNK 160/2500 V2A	160	0,75	2500	10060261
PC PNK 200/2500 V2A	200	0,75	2500	10060262
PC PNK 300/2500 V2A	300	0,75	2500	10060263
PC PNK 400/2500 V2A	400	1	2500	10060264
PC PNK 500/2500 V2A	500	1	2500	10060265
PC PNK 600/2500 V2A	600	1	2500	10060266
V4A				
PC PNK 50/2500 V4A	50	1	2500	10090259
PC PNK 100/2500 V4A	100	1	2500	10090260
PC PNK 160/2500 V4A	160	1	2500	10090261
PC PNK 200/2500 V4A	200	1	2500	10090262
PC PNK 300/2500 V4A	300	1	2500	10090263
PC PNK 400/2500 V4A	400	1	2500	10090264
PC PNK 500/2500 V4A	500	1	2500	10090265
PC PNK 600/2500 V4A	600	1	2500	10090266

V2A INOX 1.4301

V4A INOX 1.4571

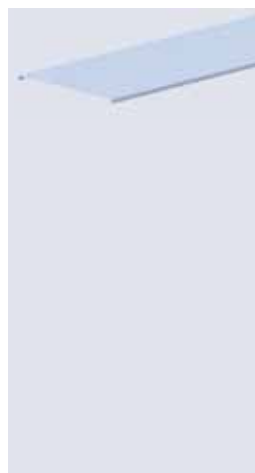

Krivina 45° H 50mm INOX / Bend 45° H 50mm INOX

INOX

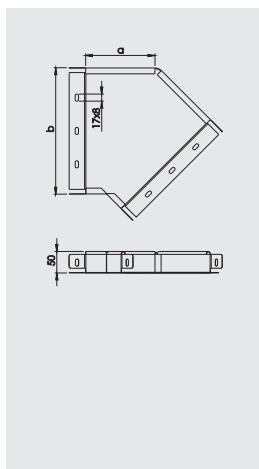

Tip Typ	Širina Width mm	Visina Height mm	Debljina Thickness mm	Šifra artikla Article
K45 PNK 5 5 V2A	50	50	1	10060009
K45 PNK 5 10 V2A	100	50	1	10060010
K45 PNK 5 16 V2A	160	50	1	10060011
K45 PNK 5 20 V2A	200	50	1	10060012
K45 PNK 5 30 V2A	300	50	1	10060013
K45 PNK 5 40 V2A	400	50	1	10060014
K45 PNK 5 50 V2A	500	50	1	10060015
K45 PNK 5 60 V2A	600	50	1	10060016
				V4A
K45 PNK 5 5 V4A	50	50	1	10090009
K45 PNK 5 10 V4A	100	50	1	10090010
K45 PNK 5 16 V4A	160	50	1	10090011
K45 PNK 5 20 V4A	200	50	1	10090012
K45 PNK 5 30 V4A	300	50	1	10090013
K45 PNK 5 40 V4A	400	50	1	10090014
K45 PNK 5 50 V4A	500	50	1	10090015
K45 PNK 5 60 V4A	600	50	1	10090016

V2A INOX 1.4301

V4A INOX 1.4571

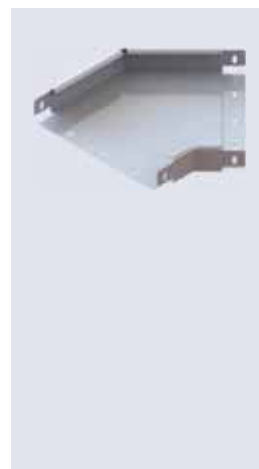

Krivina 90° H 50mm INOX / Bend 90° H 50mm INOX

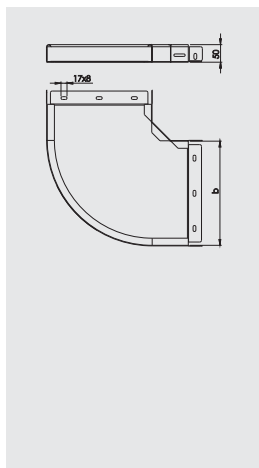

Tip Typ	Širina Width mm	Visina Height mm	Debljina Thickness mm	Šifra artikla Article
L PNK 5 5 V2A	50	50	1	10060017
L PNK 5 10 V2A	100	50	1	10060018
L PNK 5 16 V2A	160	50	1	10060019
L PNK 5 20 V2A	200	50	1	10060020
L PNK 5 30 V2A	300	50	1	10060021
L PNK 5 40 V2A	400	50	1	10060022
L PNK 5 50 V2A	500	50	1	10060023
L PNK 5 60 V2A	600	50	1	10060024
				V4A
L PNK 5 5 V4A	50	50	1	10090017
L PNK 5 10 V4A	100	50	1	10090018
L PNK 5 16 V4A	160	50	1	10090019
L PNK 5 20 V4A	200	50	1	10090020
L PNK 5 30 V4A	300	50	1	10090021
L PNK 5 40 V4A	400	50	1	10090022
L PNK 5 50 V4A	500	50	1	10090023
L PNK 5 60 V4A	600	50	1	10090024

V2A INOX 1.4301

V4A INOX 1.4571



PNK T račva H 50mm INOX / T Module PNK H 50mm INOX

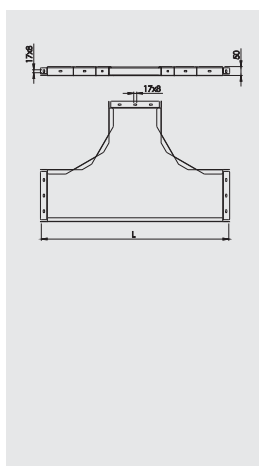

Tip Typ	Širina Width mm	Visina Height mm	Debljina Thickness mm	Šifra artikla Article
T PNK 5 5 V2A	50	50	1	10060204
T PNK 5 10 V2A	100	50	1	10060205
T PNK 5 16 V2A	160	50	1	10060206
T PNK 5 20 V2A	200	50	1	10060207
T PNK 5 30 V2A	300	50	1	10060208
T PNK 5 40 V2A	400	50	1	10060209
T PNK 5 50 V2A	500	50	1	10060210
T PNK 5 60 V2A	600	50	1	10060211
				V4A
T PNK 5 5 V4A	50	50	1	10090204
T PNK 5 10 V4A	100	50	1	10090205
T PNK 5 16 V4A	160	50	1	10090206
T PNK 5 20 V4A	200	50	1	10090207
T PNK 5 30 V4A	300	50	1	10090208
T PNK 5 40 V4A	400	50	1	10090209
T PNK 5 50 V4A	500	50	1	10090210
T PNK 5 60 V4A	600	50	1	10090211

V2A INOX 1.4301

V4A INOX 1.4571

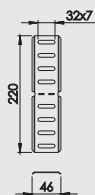

Lomljiva spojnica PNK H 50mm INOX / Angle connector PNK H 50mm INOX
INOX

Tip Typ	Visina Height	Pakovanje Pack kom piece	Šifra artikla Article
LS PNK 50 V2A	50	50	V2A 10060025
LS PNK 50 V4A	50	50	V4A 10090025

V2A INOX 1.4301

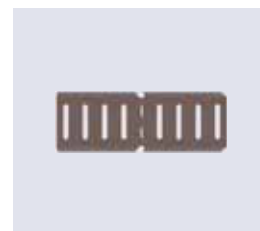
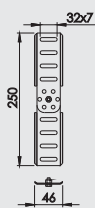
V4A INOX 1.4571

Zglobna spojnica PNK H 50mm INOX / Adjustable connector PNK H 50mm INOX

Tip Typ	Visina Height	Pakovanje Pack kom piece	Šifra artikla Article
ZS PNK 50 V2A	50	50	V2A 10060026
ZS PNK 50 V4A	50	50	V4A 10090026

V2A INOX 1.4301

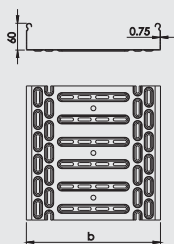
V4A INOX 1.4571

Nosač kablova PNK H 60mm INOX / PNK cable trays H 60mm INOX

Tip Typ	Širina Width	Visina Height	Debljina Thickness	Dužina Length	Korisni presek Useful section	Dozvoljeno opterećenje Allowed load			Šifra artikla Article
						1.5 m	2.0 m	2.5 m	
PNK 6 5 300 V2A	50	60	0.75	3000	28	121	80	50	V2A 10060027
PNK 6 10 300 V2A	100	60	0.75	3000	58	120	78	49	10060028
PNK 6 16 300 V2A	160	60	0.75	3000	78	123	79	48	10060029
PNK 6 20 300 V2A	200	60	0.75	3000	118	132	77	47	10060030
PNK 6 30 300 V2A	300	60	0.75	3000	178	112	78	42	10060031
PNK 6 40 300 V2A	400	60	1	3000	238	153	123	69	10060032
PNK 6 50 300 V2A	500	60	1	3000	298	156	125	62	10060033
PNK 6 60 300 V2A	600	60	1	3000	358	158	128	62	10060034
PNK 6 5 300 V4A	50	60	0.75	3000	28	121	80	50	V4A 10090027
PNK 6 10 300 V4A	100	60	0.75	3000	58	121	80	50	10090028
PNK 6 16 300 V4A	160	60	0.75	3000	78	123	79	48	10090029
PNK 6 20 300 V4A	200	60	0.75	3000	118	132	77	47	10090030
PNK 6 30 300 V4A	300	60	0.75	3000	178	112	78	42	10090031
PNK 6 40 300 V4A	400	60	1	3000	238	153	123	69	10090032
PNK 6 50 300 V4A	500	60	1	3000	298	156	125	62	10090033
PNK 6 60 300 V4A	600	60	1	3000	358	158	128	62	10090034

V2A INOX 1.4301

V4A INOX 1.4571

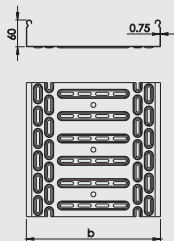
Nosač kablova PNK H 60mm L=2500mm INOX / PNK cable trays H 60mm L=2500mm INOX

Tip Typ	Širina Width	Visina Height	Debljina Thickness	Dužina Length	Korisni presek Useful section	Dozvoljeno opterećenje Allowed load			Šifra artikla Article
						1.5 m	2.0 m	2.5 m	
PNK 6 5 250 V2A	50	60	0.75	2500	23	123	78	44	V2A 10060251
PNK 6 10 250 V2A	100	60	0.75	2500	48	121	80	50	10060252
PNK 6 16 250 V2A	160	60	0.75	2500	78	128	81	48	10060253
PNK 6 20 250 V2A	200	60	0.75	2500	98	132	77	47	10060254
PNK 6 30 250 V2A	300	60	0.75	2500	148	112	78	42	10060255
PNK 6 40 250 V2A	400	60	1	2500	198	153	123	69	10060256
PNK 6 50 250 V2A	500	60	1	2500	248	156	125	62	10060257
PNK 6 60 250 V2A	600	60	1	2500	298	158	128	62	10060258
PNK 6 5 250 V4A	50	60	0.75	2500	23	123	78	44	V4A 10090251
PNK 6 10 250 V4A	100	60	0.75	2500	48	121	80	50	10090252
PNK 6 16 250 V4A	160	60	0.75	2500	78	128	81	48	10090253
PNK 6 20 250 V4A	200	60	0.75	2500	98	132	77	47	10090254
PNK 6 30 250 V4A	300	60	0.75	2500	148	112	78	42	10090255
PNK 6 40 250 V4A	400	60	1	2500	198	153	123	69	10090256
PNK 6 50 250 V4A	500	60	1	2500	248	156	125	62	10090257
PNK 6 60 250 V4A	600	60	1	2500	298	158	128	62	10090258

V2A INOX 1.4301

V4A INOX 1.4571



Nosači kablova od Inox-a

Poklopac regala PNK L=3000mm INOX / Cable tray cover L=3000mm INOX

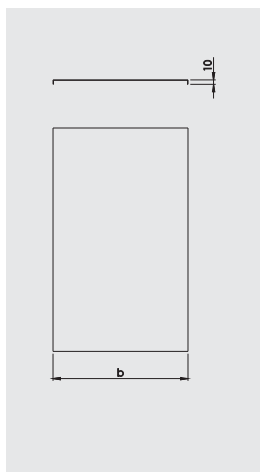
INOX

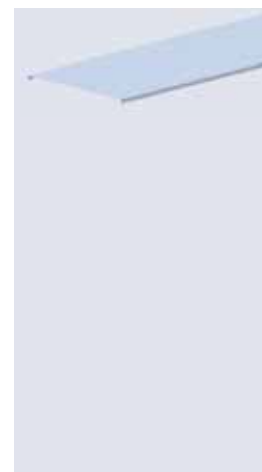

Tip Typ	Širina Width	Debljina Thickness	Dužina Length	Šifra artikla Article
	mm	mm	mm	
PC PNK 50/3000 V2A	50	0.75	3000	V2A 10060267
PC PNK 100/3000 V2A	100	0.75	3000	10060268
PC PNK 160/3000 V2A	160	0.75	3000	10060269
PC PNK 200/3000 V2A	200	0.75	3000	10060270
PC PNK 300/3000 V2A	300	0.75	3000	10060271
PC PNK 400/3000 V2A	400	1	3000	10060272
PC PNK 500/3000 V2A	500	1	3000	10060273
PC PNK 600/3000 V2A	600	1	3000	10060274
V4A				
PC PNK 50/3000 V4A	50	1	3000	10090267
PC PNK 100/3000 V4A	100	1	3000	10090268
PC PNK 160/3000 V4A	160	1	3000	10090269
PC PNK 200/3000 V4A	200	1	3000	10090270
PC PNK 300/3000 V4A	300	1	3000	10090271
PC PNK 400/3000 V4A	400	1	3000	10090272
PC PNK 500/3000 V4A	500	1	3000	10090273
PC PNK 600/3000 V4A	600	1	3000	10090274



V2A INOX 1.4301

V4A INOX 1.4571

Krivina 45° PNK H 60mm INOX / Bend 45° PNK H 60mm INOX

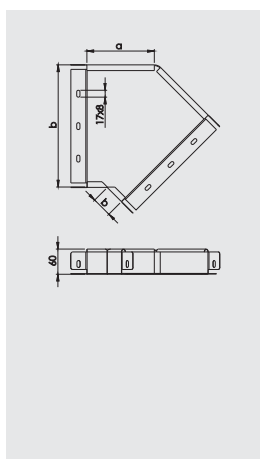

Tip Typ	Širina Width	Visina Height	Debljina Thickness	Šifra artikla Article
	mm	mm	mm	
V2A				
K45 PNK 6 5 V2A	50	60	1	10060035
K45 PNK 6 10 V2A	100	60	1	10060036
K45 PNK 6 16 V2A	160	60	1	10060037
K45 PNK 6 20 V2A	200	60	1	10060038
K45 PNK 6 30 V2A	300	60	1	10060039
K45 PNK 6 40 V2A	400	60	1	10060040
K45 PNK 6 50 V2A	500	60	1	10060041
K45 PNK 6 60 V2A	600	60	1	10060042
V4A				
K45 PNK 6 5 V4A	50	60	1	10090035
K45 PNK 6 10 V4A	100	60	1	10090036
K45 PNK 6 16 V4A	160	60	1	10090037
K45 PNK 6 20 V4A	200	60	1	10090038
K45 PNK 6 30 V4A	300	60	1	10090039
K45 PNK 6 40 V4A	400	60	1	10090040
K45 PNK 6 50 V4A	500	60	1	10090041
K45 PNK 6 60 V4A	600	60	1	10090042



V2A INOX 1.4301

V4A INOX 1.4571

Krivina PNK 90° H60mm INOX / Bend 90° PNK H60mm INOX

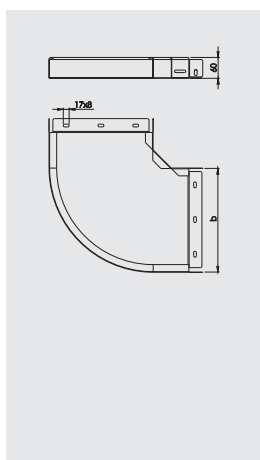

Tip Typ	Širina Width	Visina Height	Debljina Thickness	Šifra artikla Article
	mm	mm	mm	
V2A				
L PNK 6 5 V2A	50	60	1	10060043
L PNK 6 10 V2A	100	60	1	10060044
L PNK 6 16 V2A	160	60	1	10060045
L PNK 6 20 V2A	200	60	1	10060046
L PNK 6 30 V2A	300	60	1	10060047
L PNK 6 40 V2A	400	60	1	10060048
L PNK 6 50 V2A	500	60	1	10060049
L PNK 6 60 V2A	600	60	1	10060050
V4A				
L PNK 6 5 V4A	50	60	1	10090043
L PNK 6 10 V4A	100	60	1	10090044
L PNK 6 16 V4A	160	60	1	10090045
L PNK 6 20 V4A	200	60	1	10090046
L PNK 6 30 V4A	300	60	1	10090047
L PNK 6 40 V4A	400	60	1	10090048
L PNK 6 50 V4A	500	60	1	10090049
L PNK 6 60 V4A	600	60	1	10090050

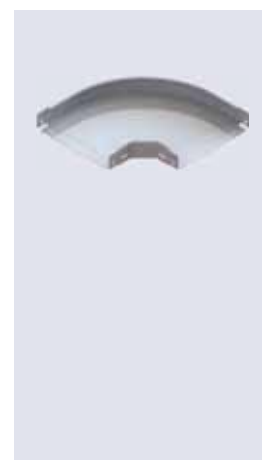

V2A INOX 1.4301

V4A INOX 1.4571

PNK T račva H 60mm INOX / T Module PNK H 60mm INOX

INOX

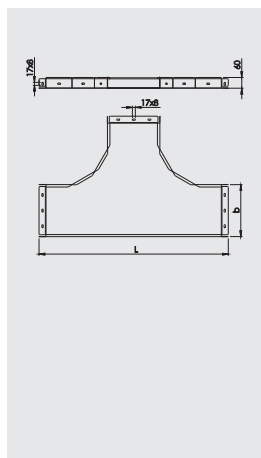

Tip Typ	Širina Width mm	Visina Height mm	Debljina Thickness mm	Šifra artikla Article
T PNK 6 5 V2A	50	60	1	V2A 10060212
T PNK 6 10 V2A	100	60	1	10060213
T PNK 6 16 V2A	160	60	1	10060214
T PNK 6 20 V2A	200	60	1	10060215
T PNK 6 30 V2A	300	60	1	10060216
T PNK 6 40 V2A	400	60	1	10060217
T PNK 6 50 V2A	500	60	1	10060218
T PNK 6 60 V2A	600	60	1	10060219
				V4A
T PNK 6 5 V4A	50	60	1	10090212
T PNK 6 10 V4A	100	60	1	10090213
T PNK 6 16 V4A	160	60	1	10090214
T PNK 6 20 V4A	200	60	1	10090215
T PNK 6 30 V4A	300	60	1	10090216
T PNK 6 40 V4A	400	60	1	10090217
T PNK 6 50 V4A	500	60	1	10090218
T PNK 6 60 V4A	600	60	1	10090219



V2A INOX 1.4301

V4A INOX 1.4571

Lomljiva spojnica PNK H 60mm INOX / Angle connector PNK H 60mm INOX

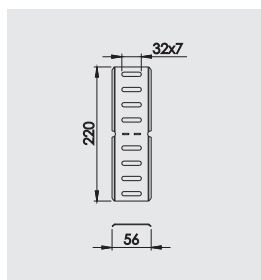

Tip Typ	Visina Height mm	Pakovanje Pack kom piece	Šifra artikla Article
LS PNK 60 V2A	60	50	V2A 10060051
LS PNK 60 V4A	60	50	V4A 10090051

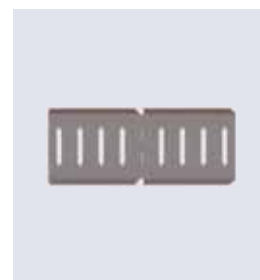

V2A INOX 1.4301

V4A INOX 1.4571

Zglobna spojnica PNK H 60mm INOX / Adjustable connector PNK H 60mm INOX

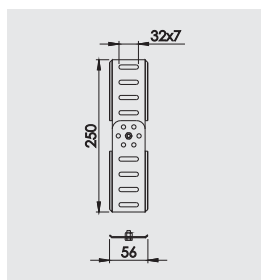

Tip Typ	Visina Height mm	Pakovanje Pack kom piece	Šifra artikla Article
ZS PNK 60 V2A	60	50	V2A 10060052
ZS PNK 60 V4A	60	50	V4A 10090052



V2A INOX 1.4301

V4A INOX 1.4571

LNK Nosač kablova H 60mm INOX / Ladder cable trays H 60mm INOX

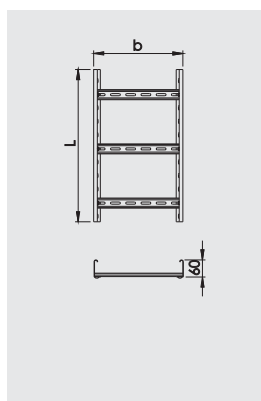

Tip Typ	Širina Width mm	Visina Height mm	Debljina Thickness mm	Dužina Length mm	Dozvoljeno opterećenje Allowed load kg/m			Šifra artikla Article
					1.5 m	2.0 m	2.5 m	
LNK 6 10 300 V2A	100	60	1.5	3000	250	200	125	V2A 10060053
LNK 6 20 300 V2A	200	60	1.5	3000	247	197	120	10060054
LNK 6 30 300 V2A	300	60	1.5	3000	245	195	120	10060055
LNK 6 40 300 V2A	400	60	1.5	3000	235	190	115	10060056
LNK 6 50 300 V2A	500	60	1.5	3000	230	185	112	10060057
LNK 6 60 300 V2A	600	60	1.5	3000	232	190	115	10060058
								V4A
LNK 6 10 300 V4A	100	60	1.5	3000	250	200	125	10090053
LNK 6 20 300 V4A	200	60	1.5	3000	247	197	120	10090054
LNK 6 30 300 V4A	300	60	1.5	3000	245	195	120	10090055
LNK 6 40 300 V4A	400	60	1.5	3000	235	190	115	10090056
LNK 6 50 300 V4A	500	60	1.5	3000	230	185	112	10090057
LNK 6 60 300 V4A	600	60	1.5	3000	232	190	115	10090058



V2A INOX 1.4301

V4A INOX 1.4571

Nosači kablova od Inox-a

LNK Krivina 90° H 60mm INOX / Ladder cable trays Bend 90° H 60mm INOX

INOX

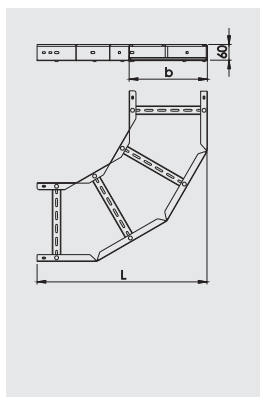

Tip Typ	Širina Width	Visina Height	Debljina Thickness	Šifra artikla Article
	mm	mm	mm	
L LNK 6 10 V2A	100	60	1.5	V2A 10060059
L LNK 6 20 V2A	200	60	1.5	10060060
L LNK 6 30 V2A	300	60	1.5	10060061
L LNK 6 40 V2A	400	60	1.5	10060062
L LNK 6 50 V2A	500	60	1.5	10060063
L LNK 6 60 V2A	600	60	1.5	10060064
V4A				
L LNK 6 10 V4A	100	60	1.5	10090059
L LNK 6 20 V4A	200	60	1.5	10090060
L LNK 6 30 V4A	300	60	1.5	10090061
L LNK 6 40 V4A	400	60	1.5	10090062
L LNK 6 50 V4A	500	60	1.5	10090063
L LNK 6 60 V4A	600	60	1.5	10090064



V2A INOX 1.4301

V4A INOX 1.4571

LNK T rača H 60mm INOX / T Module LNK H 60mm INOX

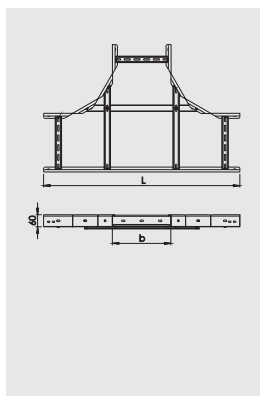

Tip Typ	Širina Width	Visina Height	Debljina Thickness	Šifra artikla Article
	mm	mm	mm	
T LNK 6 10 V2A	100	60	1.5	V2A 10060198
T LNK 6 20 V2A	200	60	1.5	10060199
T LNK 6 30 V2A	300	60	1.5	10060200
T LNK 6 40 V2A	400	60	1.5	10060201
T LNK 6 50 V2A	500	60	1.5	10060202
T LNK 6 60 V2A	600	60	1.5	10060203
V4A				
T LNK 6 10 V4A	100	60	1.5	10090198
T LNK 6 20 V4A	200	60	1.5	10090199
T LNK 6 30 V4A	300	60	1.5	10090200
T LNK 6 40 V4A	400	60	1.5	10090201
T LNK 6 50 V4A	500	60	1.5	10090202
T LNK 6 60 V4A	600	60	1.5	10090203



V2A INOX 1.4301

V4A INOX 1.4571

LNK Bočna spojnica H 60mm INOX / Ladder cable trays straight connector H60mm INOX

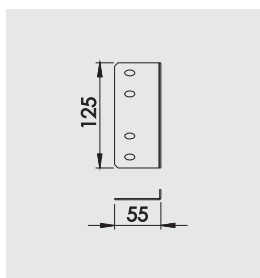

Tip Typ	Širina Width	Visina Height	Debljina Thickness	Šifra artikla Article
	mm	mm	mm	
S LNK 100 V2A	100	60	1.5	V2A 10060082
S LNK 100 V4A	100	60	1.5	V4A 10090083



V2A INOX 1.4301

V4A INOX 1.4571

Mrežasti nosač kablova MNK L 3000mm INOX / Mesh cable trays MNK L 3000mm INOX

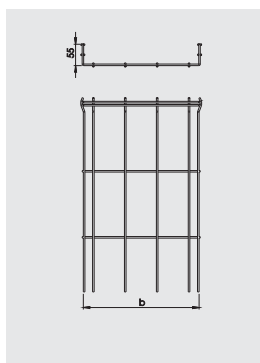

Tip Typ	Širina Width	Visina Height	Debljina žice Wire thickness	Dužina Length	Korisni presek Useful section	Šifra artikla Article
	mm	mm	mm	mm	cm ²	
MNK 50/55/3000 V2A	50	55	3.9	3000	25	V2A 10060065
MNK 100/55/3000 V2A	100	55	3.9	3000	50	10060066
MNK 200/55/3000 V2A	200	55	3.9	3000	100	10060067
MNK 300/55/3000 V2A	300	55	3.9	3000	150	10060068
MNK 400/55/3000 V2A	400	55	3.9	3000	200	10060069
V4A						
MNK 50/55/3000 V4A	50	55	3.9	3000	25	10090065
MNK 100/55/3000 V4A	100	55	3.9	3000	50	10090066
MNK 200/55/3000 V4A	200	55	3.9	3000	100	10090067
MNK 300/55/3000 V4A	300	55	3.9	3000	150	10090068
MNK 400/55/3000 V4A	400	55	3.9	3000	200	10090069

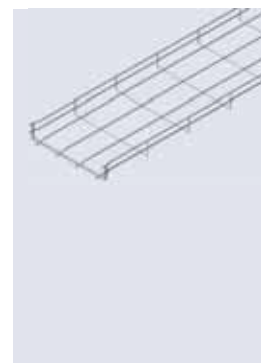

V2A INOX 1.4301

V4A INOX 1.4571

Žabica MNK regala INOX / Toogle Mesh cable trays MNK INOX

INOX

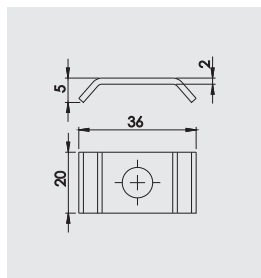

Tip Typ	Širina Width	Visina Height	Debljina Thickness	Šifra artikla Article
ŽMNK 1 V2A	mm	mm	mm	V2A 10060083
ŽMNK 1 V4A	20	5	2	V4A 10090084

V2A INOX 1.4301

V4A INOX 1.4571



Perforirani nosač kablova tipa E90 H 60mm INOX / Perforated cable trays E90 H 60mm INOX

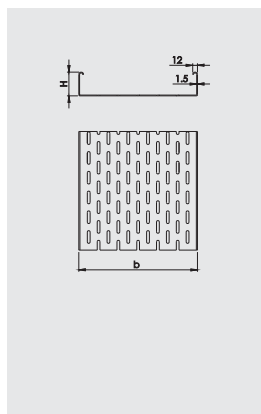

Tip Typ	Širina b Width b	Visina H Height H	Debljina Thickness	Dužina Length	Korisni presek Useful section	Šifra artikla Article
PNK 6 10 300 E90 V2A	mm	mm	mm	mm	cm ²	V2A 10060070
PNK 6 20 300 E90 V2A	100	60	1.5	3000	58	10060071
PNK 6 30 300 E90 V2A	200	60	1.5	3000	118	10060072
PNK 6 40 300 E90 V2A	300	60	1.5	3000	178	10060073
PNK 6 50 300 E90 V2A	400	60	1.5	3000	238	10060074
PNK 6 60 300 E90 V2A	500	60	1.5	3000	298	10060075
PNK 6 60 300 E90 V2A	600	60	1.5	3000	358	10060075
PNK 6 5 300 E90 V4A	50	60	1.5	3000	28	V4A 10090070
PNK 6 10 300 E90 V4A	100	60	1.5	3000	58	10090071
PNK 6 20 300 E90 V4A	200	60	1.5	3000	118	10090072
PNK 6 30 300 E90 V4A	300	60	1.5	3000	178	10090073
PNK 6 40 300 E90 V4A	400	60	1.5	3000	238	10090074
PNK 6 50 300 E90 V4A	500	60	1.5	3000	298	10090075
PNK 6 60 300 E90 V4A	600	60	1.5	3000	358	10090076

V2A INOX 1.4301

V4A INOX 1.4571



Lestvičasti nosač kablova tipa E90 H 60mm INOX / Ladder cable trays E90 H 60mm INOX

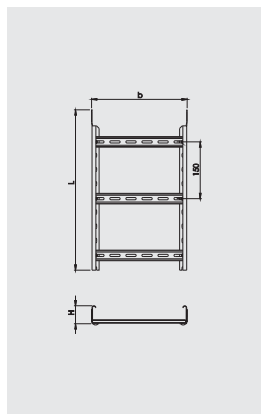

Tip Typ	Širina b Width b	Visina H Height H	Debljina Thickness	Dužina Length	Korisni presek Useful section	Šifra artikla Article
LNK 6 10 300 E90 V2A	mm	mm	mm	mm	cm ²	V2A 10060076
LNK 6 20 300 E90 V2A	100	60	1.5	3000	58	10060077
LNK 6 30 300 E90 V2A	200	60	1.5	3000	118	10060078
LNK 6 40 300 E90 V2A	300	60	1.5	3000	178	10060079
LNK 6 50 300 E90 V2A	400	60	1.5	3000	238	10060080
LNK 6 60 300 E90 V2A	500	60	1.5	3000	298	10060081
LNK 6 60 300 E90 V2A	600	60	1.5	3000	358	10060081
LNK 6 10 300 E90 V4A	100	60	1.5	3000	58	V4A 10090077
LNK 6 20 300 E90 V4A	200	60	1.5	3000	118	10090078
LNK 6 30 300 E90 V4A	300	60	1.5	3000	178	10090079
LNK 6 40 300 E90 V4A	400	60	1.5	3000	238	10090080
LNK 6 50 300 E90 V4A	500	60	1.5	3000	298	10090081
LNK 6 60 300 E90 V4A	600	60	1.5	3000	358	10090082

V2A INOX 1.4301

V4A INOX 1.4571



Spojnica lestvičastog nosača kablova tipa E90 H 60mm INOX / Coupling ladder cable trays E90 H 60mm INOX

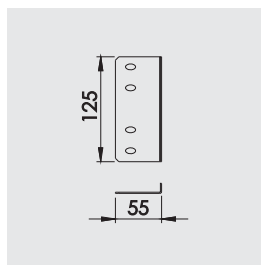

Tip Typ	Visina Height	Pakovanje Pack kom piece	Šifra artikla Article
S LNK 60 E90 V2A	mm	10	V2A 10060084
S LNK 60 E90 V4A	60	10	V4A 10090085

V2A INOX 1.4301

V4A INOX 1.4571



Nosači kablova od Inox-a

Plafonski U nosač tipa E90 INOX / Ceiling U carrier type E90 INOX

INOX

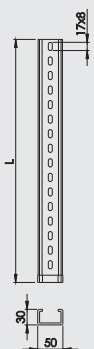

Tip Typ	Debljina Thickness	Dužina Length	Pakovanje Pack kom piece	Šifra artikla Article
U 5 20 E90 V2A	2	200	1	10060150
U 5 30 E90 V2A	2	300	1	10060151
U 5 40 E90 V2A	2	400	1	10060152
U 5 50 E90 V2A	2	500	1	10060153
U 5 60 E90 V2A	2	600	1	10060154
U 5 70 E90 V2A	2	700	1	10060155
U 5 80 E90 V2A	2	800	1	10060156
U 5 90 E90 V2A	2	900	1	10060157
U 5 100 E90 V2A	2	1000	1	10060158
U 5 150 E90 V2A	2	1500	1	10060159
U 5 200 E90 V2A	2	2000	1	10060160
V4A				
U 5 20 E90 V4A	2	200	1	10090150
U 5 30 E90 V4A	2	300	1	10090151
U 5 40 E90 V4A	2	400	1	10090152
U 5 50 E90 V4A	2	500	1	10090153
U 5 60 E90 V4A	2	600	1	10090154
U 5 70 E90 V4A	2	700	1	10090155
U 5 80 E90 V4A	2	800	1	10090156
U 5 90 E90 V4A	2	900	1	10090157
U 5 100 E90 V4A	2	1000	1	10090158
U 5 150 E90 V4A	2	1500	1	10090159
U 5 200 E90 V4A	2	2000	1	10090160

V2A INOX 1.4301

V4A INOX 1.4571



Kosi nosač tipa E90 INOX / Bevel carrier, type E90 INOX

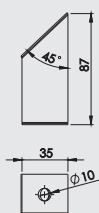

Tip Typ	Debljina Thickness	Pakovanje Pack kom piece	Šifra artikla Article
KS E90 V2A	2	10	10060161
KS E90 V4A	2	10	10090161

V2A INOX 1.4301

V4A INOX 1.4571



Zidna i konzola nosača tipa E90 INOX / Wall cantilever carrier, type E90 INOX

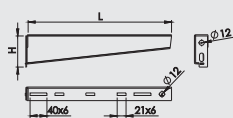

Tip Typ	Debljina Thickness	Dužina Length	Pakovanje Pack kom piece	Šifra artikla Article
KZ PNK 50 E90 V2A	2	80	10	10060162
KZ PNK 100 E90 V2A	2	130	10	10060163
KZ PNK 160 E90 V2A	2	190	10	10060164
KZ PNK 200 E90 V2A	2	230	10	10060165
KZ PNK 300 E90 V2A	2	330	10	10060166
KZ PNK 400 E90 V2A	2	430	10	10060167
KZ PNK 500 E90 V2A	2	530	10	10060168
KZ PNK 600 E90 V2A	2	630	10	10060169
V4A				
KZ PNK 50 E90 V4A	2	80	10	10090162
KZ PNK 100 E90 V4A	2	130	10	10090163
KZ PNK 160 E90 V4A	2	190	10	10090164
KZ PNK 200 E90 V4A	2	230	10	10090165
KZ PNK 300 E90 V4A	2	330	10	10090166
KZ PNK 400 E90 V4A	2	430	10	10090167
KZ PNK 500 E90 V4A	2	530	10	10090168
KZ PNK 600 E90 V4A	2	630	10	10090169

V2A INOX 1.4301

V4A INOX 1.4571

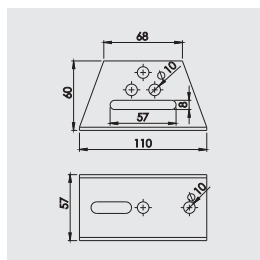

UD nosač tipa E90 INOX / UD carrier, type E90 INOX

INOX

Tip Typ	Debljina Thickness	Pakovanje Pack kom piece	Šifra artikla Article
UD U5 E90 V2A	mm 2	10	V2A 10060170
UD U5 E90 V4A	2	10	V4A 10090170

V2A INOX 1.4301

V4A INOX 1.4571

Odstojnik tipa E90 INOX / Spacer, type E90 INOX

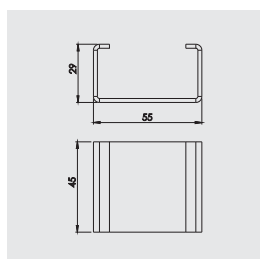

Tip Typ	Debljina Thickness	Pakovanje Pack kom piece	Šifra artikla Article
OD U5 E90 V2A	mm 2	10	V2A 10060182
OD U5 E90 V4A	2	10	V4A 10090182

V2A INOX 1.4301

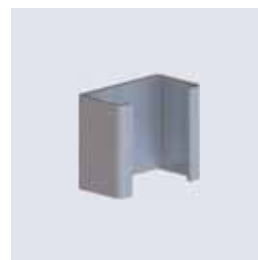
V4A INOX 1.4571

Profila perforirana sina tipa E90 INOX / Profile perforated track, type E90 INOX

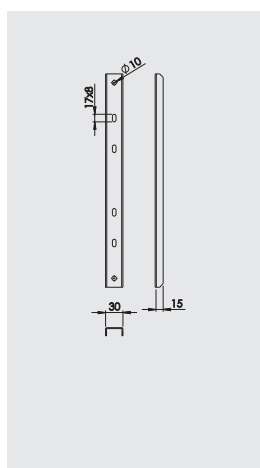

Tip Typ	Dimenzije Dimensions	Debljina Thickness	Dužina Length	Pakovanje Pack kom piece	Šifra artikla Article
PS L 2M E90 V2A	mm 30x15	mm 2	mm 2000	10	V2A 10060183
PS L 14 E90 V2A	30x15	2	140	10	10060184
PS L 20 E90 V2A	30x15	2	200	10	10060185
PS L 24 E90 V2A	30x15	2	240	10	10060186
PS L 34 E90 V2A	30x15	2	340	10	10060187
PS L 44 E90 V2A	30x15	2	440	10	10060188
PS L 54 E90 V2A	30x15	2	540	10	10060189
PS L 64 E90 V2A	30x15	2	640	10	10060190
PS L 2M E90 V4A	30x15	2	2000	10	V4A 10090183
PS L 14 E90 V4A	30x15	2	140	10	10090184
PS L 20 E90 V4A	30x15	2	200	10	10090185
PS L 24 E90 V4A	30x15	2	240	10	10090186
PS L 34 E90 V4A	30x15	2	340	10	10090187
PS L 44 E90 V4A	30x15	2	440	10	10090188
PS L 54 E90 V4A	30x15	2	540	10	10090189
PS L 64 E90 V4A	30x15	2	640	10	10090190

V2A INOX 1.4301

V4A INOX 1.4571

Spojnica PNK nosača E90 INOX / Connector PNK cable tray E90 INOX

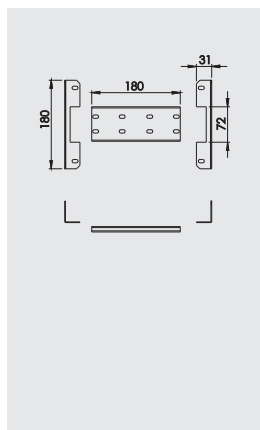

Tip Typ	Širina b Width b	Debljina Thickness	Pakovanje Pack kom piece	Šifra artikla Article
S PNK 50 E90 V2A	mm 50	mm 1.5	10	V2A 10060191
S PNK 100 E90 V2A	100	1.5	10	10060192
S PNK 200 E90 V2A	200	1.5	10	10060193
S PNK 300 E90 V2A	300	1.5	10	10060194
S PNK 400 E90 V2A	400	1.5	10	10060195
S PNK 500 E90 V2A	500	1.5	10	10060196
S PNK 600 E90 V2A	600	1.5	10	10060197
S PNK 50 E90 V4A	50	1.5	10	V4A 10090191
S PNK 100 E90 V4A	100	1.5	10	10090192
S PNK 200 E90 V4A	200	1.5	10	10090193
S PNK 300 E90 V4A	300	1.5	10	10090194
S PNK 400 E90 V4A	400	1.5	10	10090195
S PNK 500 E90 V4A	500	1.5	10	10090196
S PNK 600 E90 V4A	600	1.5	10	10090197

V2A INOX 1.4301

V4A INOX 1.4571

Nosači kablova od Inox-a

Čelični tipli INOX / Steel anchor INOX

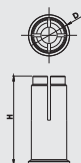
INOX

Tip Typ	Prečnik burgije Diameter of the drill	Min. dubina vijka Minimum drill depth	Maks. dubina vijka Maximum drill depth	Pakovanje Pack kom piece	Šifra artikla Article
EA II M8 x 30 V2A	10 / M8	8	13	50	V2A 10060220
EA II M10 x 40 V2A	12 / M10	10	17	50	V2A 10060221
EA II M8 x 30 V4A	10 / M8	8	13	50	V4A 10090220
EA II M10 x 40 V4A	12 / M10	10	17	50	V4A 10090221

V2A INOX 1.4301

V4A INOX 1.4571

Anker vijak INOX / Anchor screw INOX



Tip Typ	Efektivna dubina bušenja Effective drilling length	Dužina ankera Length anchor	Maks. korisna dužina Maximum useful length	Pakovanje Pack kom piece	Šifra artikla Article
FAZ II 8/10 V2A	10 / M8	75	10	50	V2A 10060223
FAZ II 8/30 V2A	12 / M10	95	30	50	V2A 10060224
FAZ II 10/10 V2A	12 / M10	95	10	50	V2A 10060225
FAZ II 10/20 V2A	10 / M8	105	20	25	V2A 10060226
FAZ II 8/10 V4A	10 / M8	75	10	50	V4A 10090223
FAZ II 8/30 V4A	12 / M10	95	30	50	V4A 10090224
FAZ II 10/10 V4A	12 / M10	95	10	50	V4A 10090225
FAZ II 10/20 V4A	10 / M8	105	20	25	V4A 10090226

V2A INOX 1.4301

V4A INOX 1.4571

Navojna šipka INOX / Threaded rod INOX



Tip Typ	Dužina Length	Prečnik Diameter	Pakovanje Pack kom piece	Šifra artikla Article
Navojna šipka M8 V2A	1000	8	10	V2A 10060233
Navojna šipka M10 V2A	1000	10	10	V2A 10060234
Navojna šipka M8 V4A	1000	8	10	V4A 10090233
Navojna šipka M10 V4A	1000	10	10	V4A 10090234

V2A INOX 1.4301

V4A INOX 1.4571

Torban vijak INOX / Carriage bolt INOX



Tip Typ	Dužina Length	Prečnik Diameter	Pakovanje Pack kom piece	Šifra artikla Article
Torban vijak M6 V2A	12	6	250	V2A 10060235
Torban vijak M8 V2A	16	8	250	V2A 10060236
Torban vijak M6 V4A	12	6	250	V4A 10090235
Torban vijak M8 V4A	16	8	250	V4A 10090236

V2A INOX 1.4301

V4A INOX 1.4571

Nazubljena matica INOX / Hex flange nut INOX

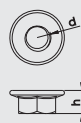

Tip Typ	Prečnik otvora Diameter hole	Pakovanje Pack kom piece	Šifra artikla Article
Nazubljena matica M6 V2A	6	400	V2A 10060237
Nazubljena matica M8 V2A	8	400	V2A 10060238
Nazubljena matica M6 V4A	6	400	V4A 10090237
Nazubljena matica M8 V4A	8	400	V4A 10090238

V2A INOX 1.4301

V4A INOX 1.4571

Podloška INOX / Washer INOX

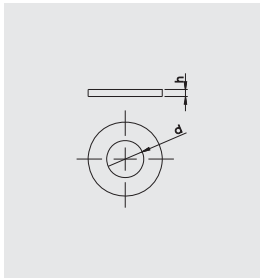
INOX

Tip Typ	Prečnik otvora Hole diameter	Pakovanje Pack kom piece	Šifra artikla Article
Podloška M8 V2A Podloška M10 V2A	mm 8 10	400 400	V2A 10060239 10060240
Podloška M8 V4A Podloška M10 V4A	8 10	400 400	V4A 10090239 10090240

V2A INOX 1.4301

V4A INOX 1.4571

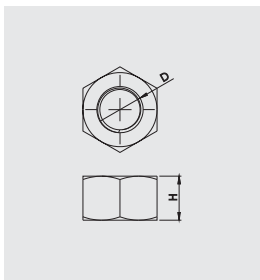

Matica INOX / Nut INOX



Tip Typ	Prečnik otvora Diameter hole	Pakovanje Pack kom piece	Šifra artikla Article
Matica M8 V2A Matica M10 V2A	mm 8 10	400 400	V2A 10060241 10060242
Matica M8 V4A Matica M10 V4A	8 10	400 400	V4A 10090241 10090242

V2A INOX 1.4301

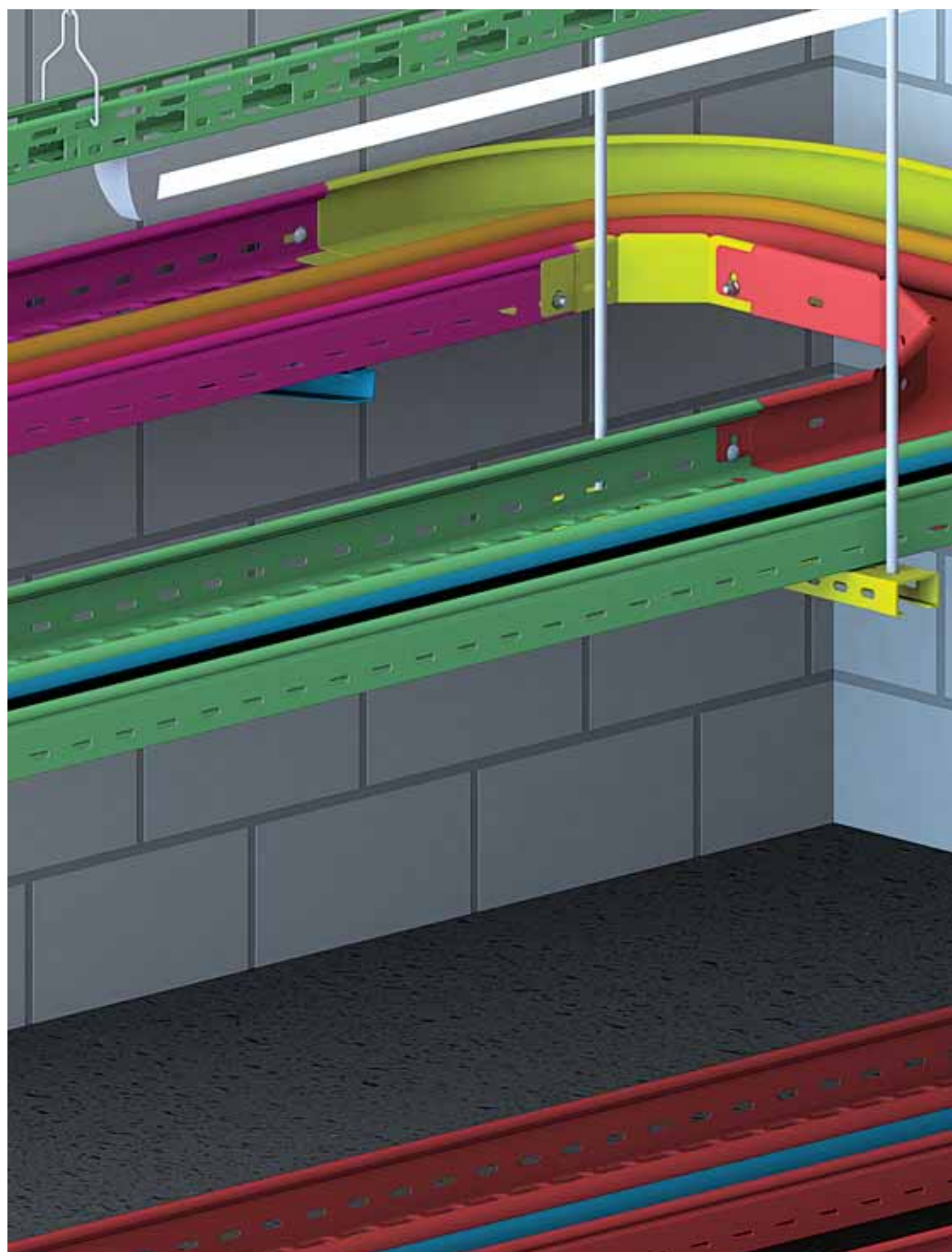
V4A INOX 1.4571

CR

8

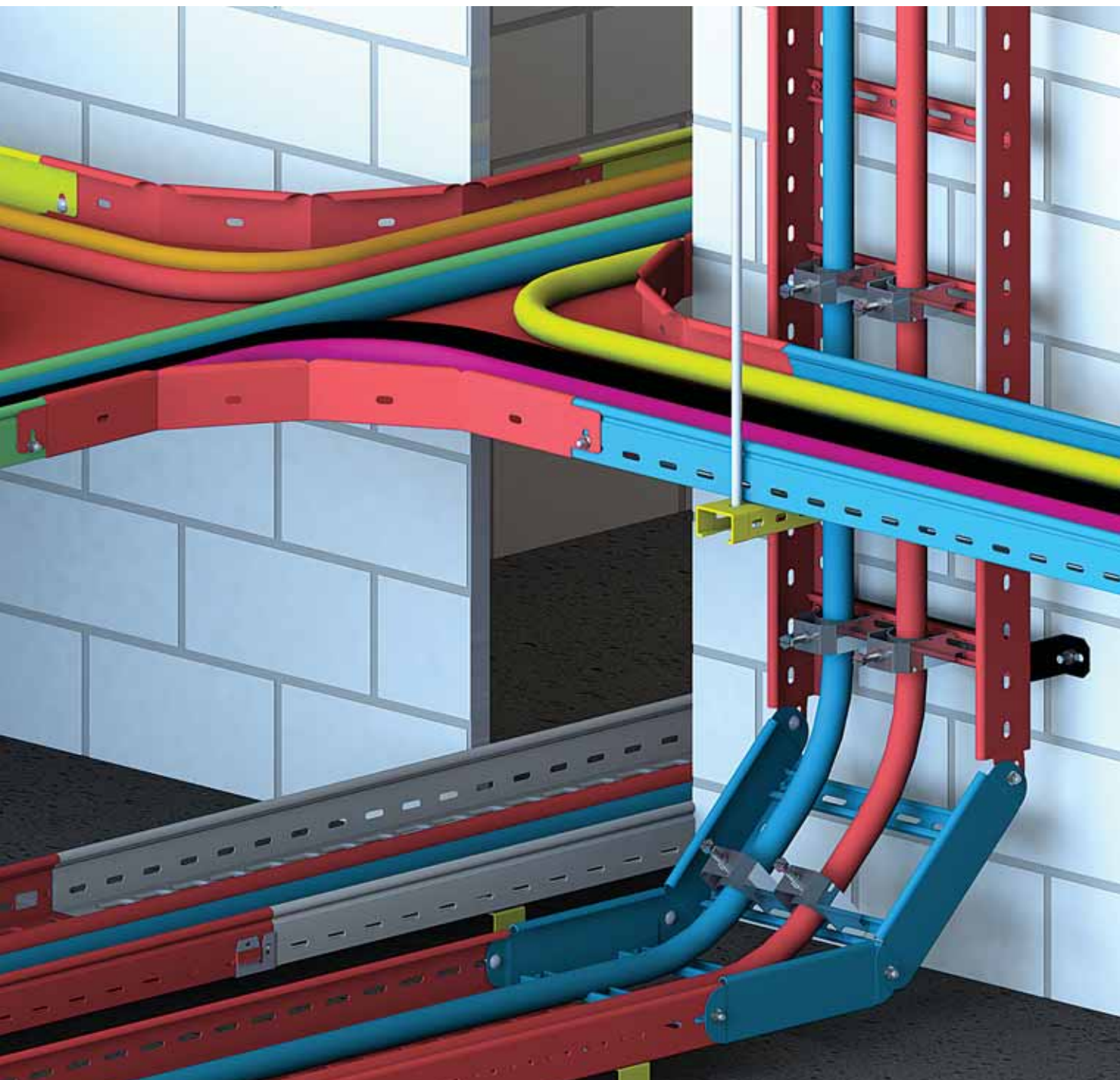

PLASTIFICIRANI NOSAČI KABLOVA

PLASTIFICIZED CABLE TRAY SYSTEMS

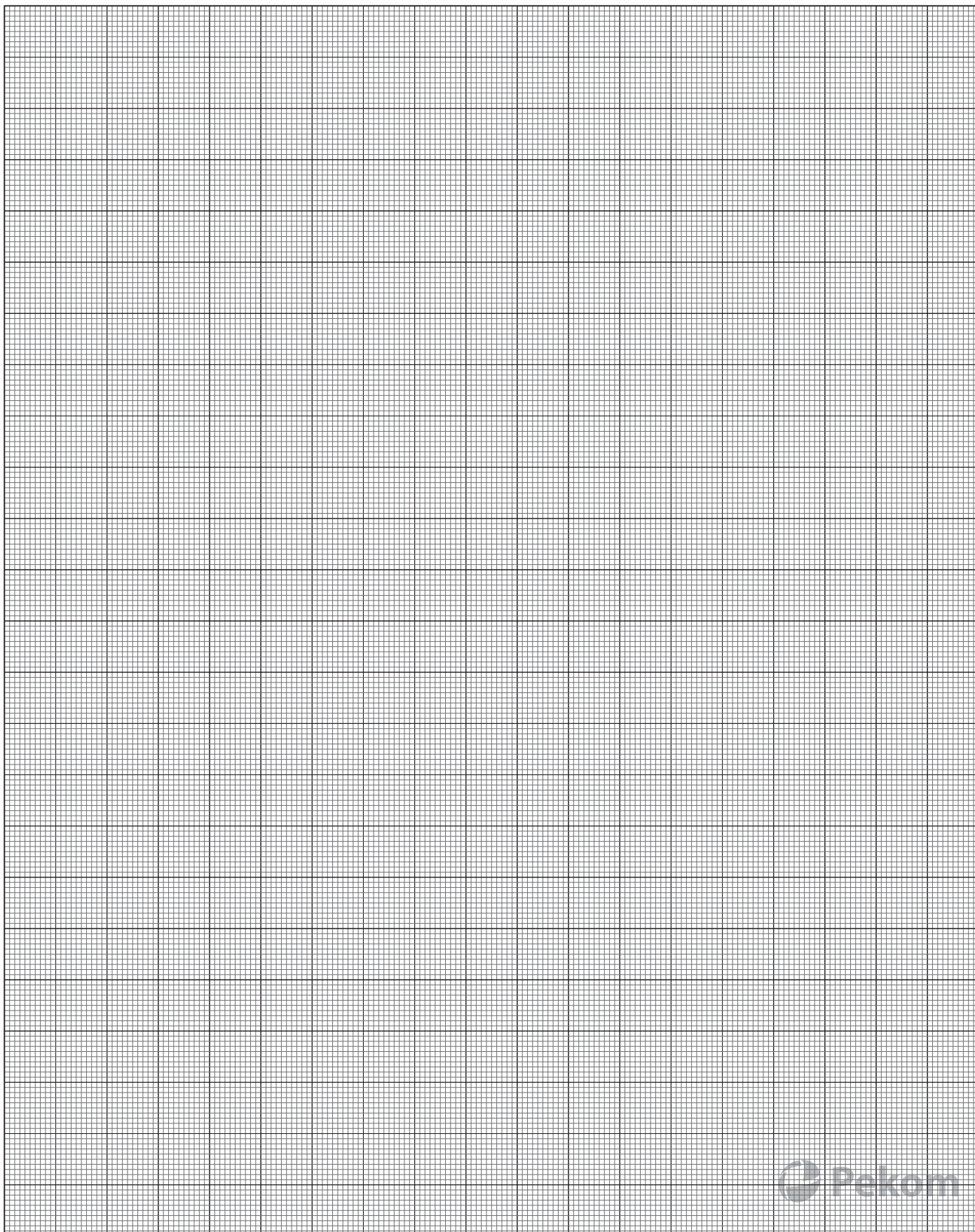

Plafonski UD nosač PLASTIFICIRAN / Ceiling UD carrier PLASTIFICIZED

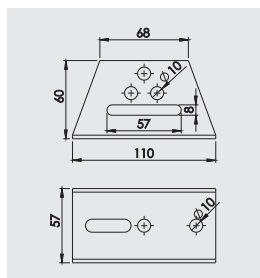
CR

Tip Typ	Debljina Thickness	Nosivost Load	Pakovanje Pack kom piece	Šifra artikla Article
UD U5 CR	mm 2	kg 611	10	CR 10110001

CR RAL boje / RAL colours



U profil PLASTIFICIRAN / U profile PLASTIFICIZED

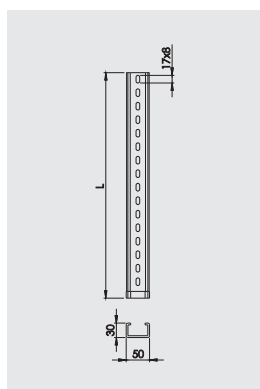

Tip Typ	Dužina L Length L	Dimenzije Dimensions	Debljina Thickness	Pakovanje Pack kom piece	Šifra artikla Article
U 5 20 CR	200	50x30	2	10	CR 10110002
U 5 30 CR	300	50x30	2	10	10110003
U 5 40 CR	400	50x30	2	10	10110004
U 5 50 CR	500	50x30	2	10	10110005
U 5 60 CR	600	50x30	2	6	10110006
U 5 70 CR	700	50x30	2	6	10110007
U 5 80 CR	800	50x30	2	6	10110008
U 5 90 CR	900	50x30	2	6	10110009
U 5 100 CR	1000	50x30	2	4	10110010
U 5 150 CR	1500	50x30	2	4	10110011
U 5 200 CR	2000	50x30	2	4	10110012
U 5 300 CR	3000	50x30	2	4	10110013

CR RAL boje / RAL colours

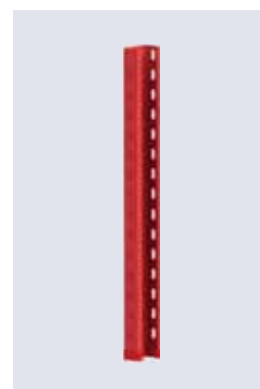

Spojnica U stuba PLASTIFICIRAN / Clip U pillar PLASTIFICIZED

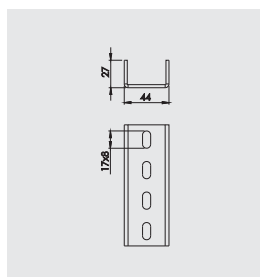

Tip Typ	Dužina L Length L	Debljina Thickness	Pakovanje Pack kom piece	Šifra artikla Article
S U5 CR	mm 200	mm 2	10	CR 10110014

CR RAL boje / RAL colours



Odstojnik za U stub INOX PLASTIFICIRAN / Spacer for U pillar PLASTIFICIZED

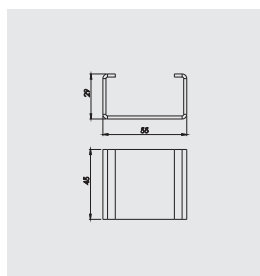

Tip Typ	Debljina Thickness	Pakovanje Pack kom piece	Šifra artikla Article
OD U5 CR	mm 2	10	CR 10110015

CR RAL boje / RAL colours

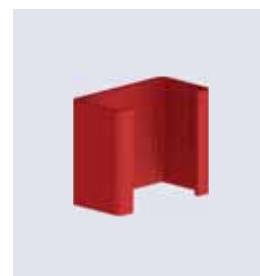

Konzola PLASTIFICIRAN / Cantilever PLASTIFICIZED

CR

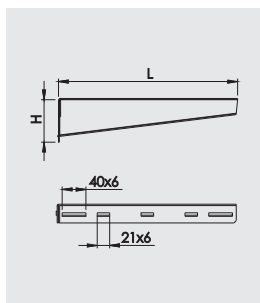

Tip Typ	Dužina Length L mm	Visina Height H mm	Debjina Thickness D mm	Nosivost Load kg	Pakovanje Pack kom piece	Sifra artikla Article CR
KZ PNK 50 CR	50	60	2	129	10	10110016
KZ PNK 100 CR	100	60	2	130	10	10110017
KZ PNK 160 CR	160	60	2	131	10	10110018
KZ PNK 200 CR	200	60	2	132	10	10110019
KZ PNK 300 CR	300	60	2	128	10	10110020
KZ PNK 400 CR	400	60	2	126	10	10110021
KZ PNK 500 CR	500	93	2	121	10	10110022
KZ PNK 600 CR	600	93	2	118	10	10110023

CR RAL boje / RAL colours



Nosao za trapezni lim PLASTIFICIRAN / Carrier for trapezoidal sheet PLASTIFICIZED

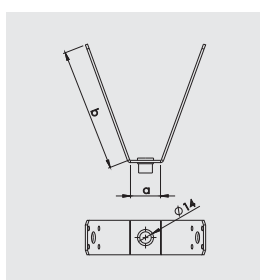

Tip Typ	Debjina Thickness mm	Centralni otvor Hole mm	Pakovanje Pack kom piece	Sifra artikla Article CR
TL 8 CR	2	M8	10	10110024
TL 10 CR	2	M10	10	10110025

CR RAL boje / RAL colours



Plafonski G nosao PLASTIFICIRAN / Ceiling G carrier PLASTIFICIZED

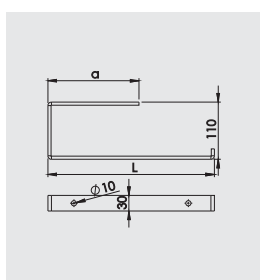

Tip Typ	Dužina L Length L mm	Otvor Hole mm	Debjina Thickness mm	Nosivost Load kg	Pakovanje Pack kom piece	Sifra artikla Article CR
G PNK 100 CR	100	10	6	78	10	10110026
G PNK 160 CR	160	10	6	67	10	10110027
G PNK 200 CR	200	10	6	63	10	10110028
G PNK 300 CR	300	10	6	40	10	10110029

CR RAL boje / RAL colours



C nosao PLASTIFICIRAN / C carrier PLASTIFICIZED

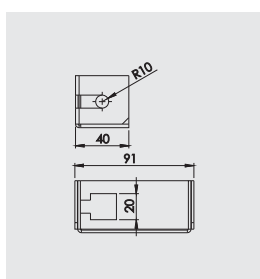

Tip Typ	Debjina Thickness mm	Pakovanje Pack kom piece	Sifra artikla Article CR
CN CR	2	10	10110030

CR RAL boje / RAL colours

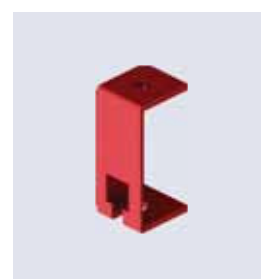

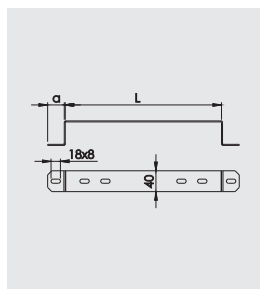
Odstojnik PLASTIFICIRAN / Spacer PLASTIFICIZED
CR

Tip Typ	Dužina L Lenght L	Pakovanje Pack kom piece	Šifra artikla Article
	mm		CR
OD 10 CR	100	10	10110031
OD 16 CR	160	10	10110032
OD 20 CR	200	10	10110033
OD 30 CR	300	10	10110034
OD 40 CR	400	10	10110035
OD 50 CR	500	10	10110036
OD 60 CR	600	10	10110037

CR RAL boje / RAL colours

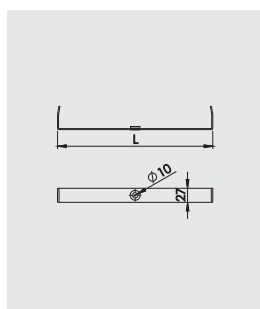
Središnji nosač PLASTIFICIRAN / Central carrier PLASTIFICIZED

Tip Typ	Dužina L Lenght L	Debljina Thickness	Centralni otvor Hole	Pakovanje Pack kom piece	Šifra artikla Article
	mm	mm	mm		CR
SN 10 M8 CR	94	3	M8	10	10110038
SN 16 M8 CR	154	3	M8	10	10110039
SN 20 M8 CR	195	3	M8	10	10110040
SN 30 M8 CR	295	3	M8	10	10110041
SN 10 M10 CR	94	3	M10	10	10110042
SN 16 M10 CR	154	3	M10	10	10110043
SN 20 M10 CR	195	3	M10	10	10110044
SN 30 M10 CR	295	3	M10	10	10110045

CR RAL boje / RAL colours

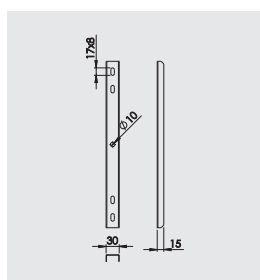
Perforirana šina sa jednom navojnom šipkom PLASTIFICIRAN / Perforated track with one threaded rod PLASTIFICIZED

Tip Typ	Dužina L Lenght L	Dimenzije Dimensions	Debljina Thickness	Pakovanje Pack kom piece	Šifra artikla Article
	mm	mm	mm		CR
PS L 05 CR	50	30x15	2	10	10110046
PS L 10 CR	100	30x15	2	10	10110047
PS L 16 CR	160	30x15	2	10	10110048
PS L 20 CR	200	30x15	2	10	10110049
PS L 30 CR	300	30x15	2	10	10110050

CR RAL boje / RAL colours

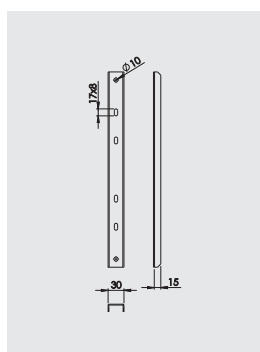
Perforirana šina sa dve navojne šipke PLASTIFICIRAN / Perforated track with two threaded rod PLASTIFICIZED

Tip Typ	Dužina L Lenght L	Dimenzije Dimensions	Debljina Thickness	Pakovanje Pack kom piece	Šifra artikla Article
	mm	mm	mm		CR
PS L 2M 15 CR	2000	30x15	1,5	10	10110051
PS L 2M 20 CR	2000	30x15	2	10	10110052
PS L 13 CR	130	30x15	2	10	10110053
PS L 18 CR	180	30x15	2	10	10110054
PS L 24 CR	240	30x15	2	10	10110055
PS L 28 CR	280	30x15	2	10	10110056
PS L 38 CR	380	30x15	2	10	10110057
PS L 48 CR	480	30x15	2	10	10110058
PS L 58 CR	580	30x15	2	10	10110059
PS L 68 CR	680	30x15	2	10	10110060

CR RAL boje / RAL colours



Perforirani L profil PLASTIFICIRAN / Perforated L Profile PLASTIFICIZED

CR

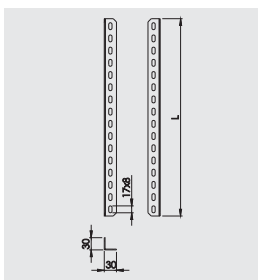

Tip Typ	Dužina L Length L	Dimenzije Dimensions	Debljina Thickness	Pakovanje Pack kom piece	Šifra artikla Article
UP L 2M CR	2000	30x30	2	10	CR 10110061

CR RAL boje / RAL colours



Perforirana traka PLASTIFICIRAN / Perforated strip PLASTIFICIZED

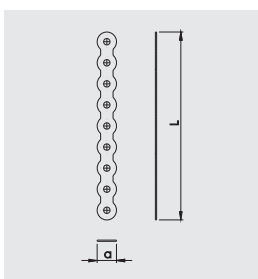

Tip Typ	Dužina L Length L	Širina Width	Otvor Diameter	Pakovanje Pack kom piece	Šifra artikla Article
PTR L 3M 6.2 CR	3000	18	6.2	10	CR 10110062
PTR L 3M 8.2 CR	3000	18	8.2	10	10110063

CR RAL boje / RAL colours



Perforirana traka velike nosivosti PLASTIFICIRAN / Perforated strip large capacity PLASTIFICIZED

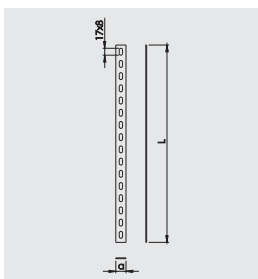

Tip Typ	Dužina L Length L	Širina Width	Debljina Thickness	Pakovanje Pack kom piece	Šifra artikla Article
PTR L 2M CR	2000	25	2	10	CR 10110064

CR RAL boje / RAL colours

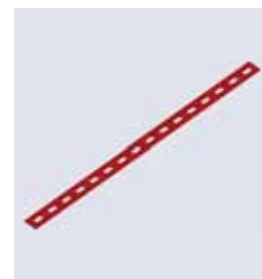

Nosač kablova PNK H 50mm PLASTIFICIRAN / PNK cable trays H 50mm PLASTIFICIZED

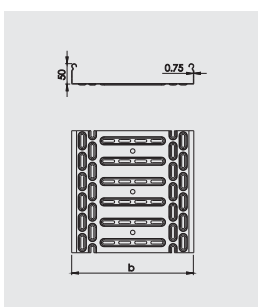

Tip Typ	Širina Width	Visina Height	Debljina Thickness	Dužina Length	Korisni presek Useful section	Dozvoljeno opterećenje Allowed load			Šifra artikla Article
						1.5 m	2.0 m	2.5 m	
PNK 5 5 300 CR	50	50	0.75	3000	23	123	78	44	CR 10110065
PNK 5 10 300 CR	100	50	0.75	3000	48	121	80	50	10110066
PNK 5 16 300 CR	160	50	0.75	3000	78	128	81	48	10110067
PNK 5 20 300 CR	200	50	0.75	3000	98	132	77	47	10110068
PNK 5 30 300 CR	300	50	0.75	3000	148	112	78	42	10110069
PNK 5 40 300 CR	400	50	1	3000	198	153	123	69	10110070
PNK 5 50 300 CR	500	50	1	3000	248	156	125	62	10110071
PNK 5 60 300 CR	600	50	1	3000	298	158	128	62	10110072

CR RAL boje / RAL colours

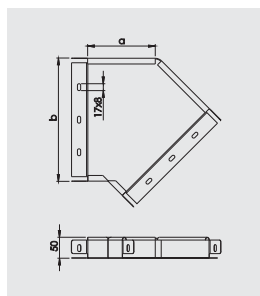

Krivina 45° H 50mm PLASTIFICIRAN / Bend 45° H 50mm PLASTIFICIZED
CR

Tip Typ	Širina Width	Visina Height	Debljina Thickness	Šifra artikla Article
	mm	mm	mm	CR
K45 PNK 5 5 CR	50	50	1	10110073
K45 PNK 5 10 CR	100	50	1	10110074
K45 PNK 5 16 CR	160	50	1	10110075
K45 PNK 5 20 CR	200	50	1	10110076
K45 PNK 5 30 CR	300	50	1	10110077
K45 PNK 5 40 CR	400	50	1	10110078
K45 PNK 5 50 CR	500	50	1	10110079
K45 PNK 5 60 CR	600	50	1	10110080

CR RAL boje / RAL colours

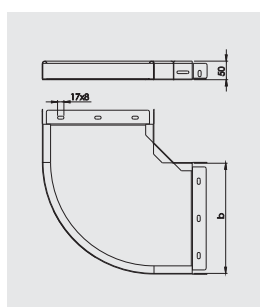
Krivina 90° H 50mm PLASTIFICIRAN / Bend 90° H 50mm PLASTIFICIZED

Tip Typ	Širina Width	Visina Height	Debljina Thickness	Šifra artikla Article
	mm	mm	mm	CR
L PNK 5 5 CR	50	50	1	10110081
L PNK 5 10 CR	100	50	1	10110082
L PNK 5 16 CR	160	50	1	10110083
L PNK 5 20 CR	200	50	1	10110084
L PNK 5 30 CR	300	50	1	10110085
L PNK 5 40 CR	400	50	1	10110086
L PNK 5 50 CR	500	50	1	10110087
L PNK 5 60 CR	600	50	1	10110088

CR RAL boje / RAL colours

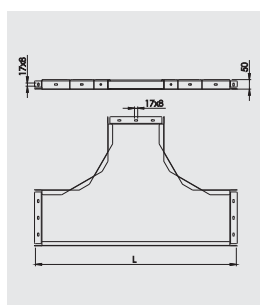
PNK T račva H 50mm PLASTIFICIRAN / T Module PNK H 50mm PLASTIFICIZED

Tip Typ	Širina Width	Visina Height	Debljina Thickness	Šifra artikla Article
	mm	mm	mm	CR
T PNK 5 5 CR	50	50	1	10110089
T PNK 5 10 CR	100	50	1	10110090
T PNK 5 16 CR	160	50	1	10110091
T PNK 5 20 CR	200	50	1	10110092
T PNK 5 30 CR	300	50	1	10110093
T PNK 5 40 CR	400	50	1	10110094
T PNK 5 50 CR	500	50	1	10110095
T PNK 5 60 CR	600	50	1	10110096

CR RAL boje / RAL colours

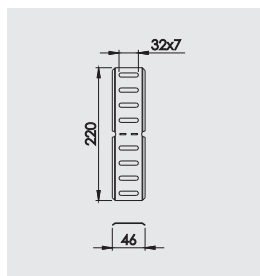
Lomljiva spojnica PNK H 50mm PLASTIFICIRAN / Angle connector PNK H 50mm PLASTIFICIZED

Tip Typ	Visina Height	Pakovanje Pack kom piece	Šifra artikla Article
LS PNK 50 CR	mm	50	CR
	50		10110097

CR RAL boje / RAL colours

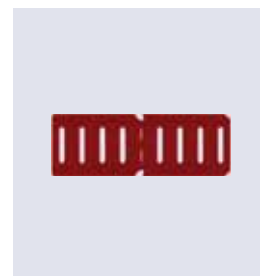

Zglobna spojnica PNK H 50mm PLASTIFICIRAN / Adjustable connector PNK H 50mm PLASTIFICIZED

CR

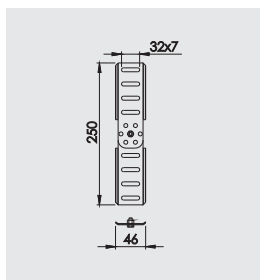

Tip Typ	Visina Height	Pakovanje Pack kom piece	Šifra artikla Article
ZS PNK 50 CR	mm 50	50	CR 10110098

CR RAL boje / RAL colours



Nosač kablova PNK H 60mm PLASTIFICIRAN / PNK cable trays H 60mm PLASTIFICIZED

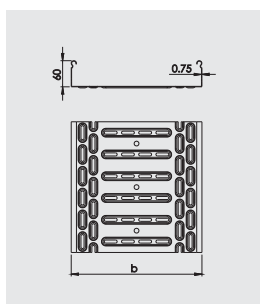

Tip Typ	Širina Width	Visina Height	Debljina Thickness	Dužina Length	Korisni presek Useful section	Dozvoljeno opterećenje Allowed load			Šifra artikla Article
						1.5 m	2.0 m	2.5 m	
PNK 6 5 300 CR	50	60	0.75	3000	28	121	80	50	CR 10110099
PNK 6 10 300 CR	100	60	0.75	3000	58	120	78	49	10110100
PNK 6 16 300 CR	160	60	0.75	3000	78	123	79	48	10110101
PNK 6 20 300 CR	200	60	0.75	3000	118	132	77	47	10110102
PNK 6 30 300 CR	300	60	0.75	3000	178	112	78	42	10110103
PNK 6 40 300 CR	400	60	1	3000	238	153	123	69	10110104
PNK 6 50 300 CR	500	60	1	3000	298	156	125	62	10110105
PNK 6 60 300 CR	600	60	1	3000	358	158	128	62	10110106

CR RAL boje / RAL colours



Krivina 45° PNK H 60mm PLASTIFICIRAN / Bend 45° PNK H 60mm PLASTIFICIZED

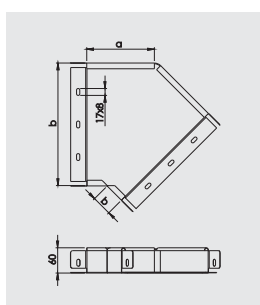

Tip Typ	Širina Width	Visina Height	Debljina Thickness	Šifra artikla Article
K45 PNK 6 5 CR	50	60	1	CR 10110107
K45 PNK 6 10 CR	100	60	1	10110108
K45 PNK 6 16 CR	160	60	1	10110109
K45 PNK 6 20 CR	200	60	1	10110110
K45 PNK 6 30 CR	300	60	1	10110111
K45 PNK 6 40 CR	400	60	1	10110112
K45 PNK 6 50 CR	500	60	1	10110113
K45 PNK 6 60 CR	600	60	1	10110114

CR RAL boje / RAL colours



Krivina PNK 90° H60mm PLASTIFICIRAN / Bend 90° PNK H60mm PLASTIFICIZED

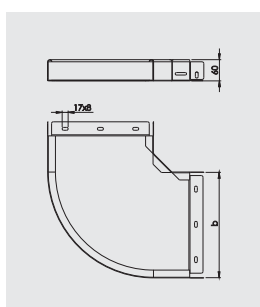

Tip Typ	Širina Width	Visina Height	Debljina Thickness	Šifra artikla Article
L PNK 6 5 CR	50	60	1	CR 10110115
L PNK 6 10 CR	100	60	1	10110116
L PNK 6 16 CR	160	60	1	10110117
L PNK 6 20 CR	200	60	1	10110118
L PNK 6 30 CR	300	60	1	10110119
L PNK 6 40 CR	400	60	1	10110120
L PNK 6 50 CR	500	60	1	10110121
L PNK 6 60 CR	600	60	1	10110122

CR RAL boje / RAL colours

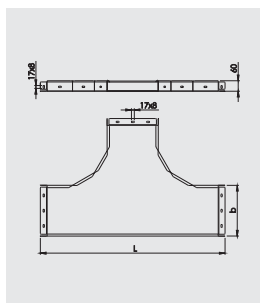

PNK T račva H 60mm PLASTIFICIRAN / T Module PNK H 60mm PLASTIFICIZED
CR

Tip Typ	Širina Width mm	Visina Height mm	Debljina Thickness mm	Šifra artikla Article CR
T PNK 6 5 CR	50	60	1	10110123
T PNK 6 10 CR	100	60	1	10110124
T PNK 6 16 CR	160	60	1	10110125
T PNK 6 20 CR	200	60	1	10110126
T PNK 6 30 CR	300	60	1	10110127
T PNK 6 40 CR	400	60	1	10110128
T PNK 6 50 CR	500	60	1	10110129
T PNK 6 60 CR	600	60	1	10110130

CR RAL boje / RAL colours

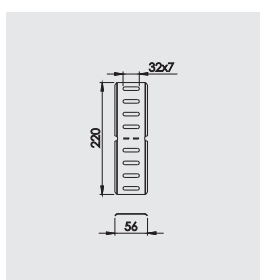
Lomljiva spojnica PNK H 60mm PLASTIFICIRAN / Angle connector PNK H 60mm PLASTIFICIZED

Tip Typ	Visina Height mm	Pakovanje Pack kom piece	Šifra artikla Article CR
LS PNK 60 CR	60	50	10110131

CR RAL boje / RAL colours

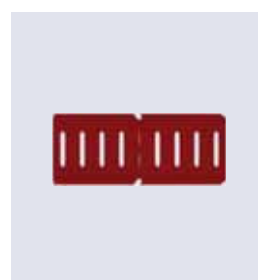
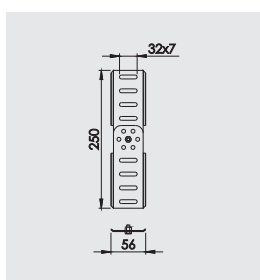
Zglobna spojnica PNK H 60mm PLASTIFICIRAN / Adjustable connector PNK H 60mm PLASTIFICIZED

Tip Typ	Visina Height mm	Pakovanje Pack kom piece	Šifra artikla Article CR
ZS PNK 60 CR	60	50	10110132

CR RAL boje / RAL colours

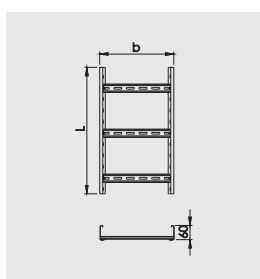
LNK Nosač kablova H 60mm PLASTIFICIRAN / Ladder cable trays H 60mm PLASTIFICIZED

Tip Typ	Širina Width mm	Visina Height mm	Debljina Thickness mm	Dužina Length mm	Dozvoljeno opterećenje Allowed load			Šifra artikla Article CR
					1.5 m	2.0 m	2.5 m	
LNK 6 10 300 CR	100	60	1.5	3000	250	200	125	10110133
LNK 6 20 300 CR	200	60	1.5	3000	247	197	120	10110134
LNK 6 30 300 CR	300	60	1.5	3000	245	195	120	10110135
LNK 6 40 300 CR	400	60	1.5	3000	235	190	115	10110136
LNK 6 50 300 CR	500	60	1.5	3000	230	185	112	10110137
LNK 6 60 300 CR	600	60	1.5	3000	232	190	115	10110138

CR RAL boje / RAL colours



LNK Krivina 90° H 60mm PLASTIFICIRAN / Ladder cable trays Bend 90° H 60mm PLASTIFICIZED

CR

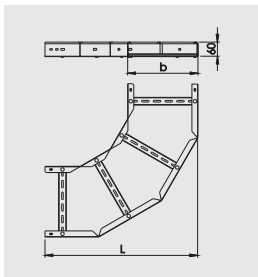

Tip Typ	Širina Width	Visina Height	Debljina Thickness	Sifra artikla Article
L LNK 6 10 CR	100	60	1.5	10110139
L LNK 6 20 CR	200	60	1.5	10110140
L LNK 6 30 CR	300	60	1.5	10110141
L LNK 6 40 CR	400	60	1.5	10110142
L LNK 6 50 CR	500	60	1.5	10110143
L LNK 6 60 CR	600	60	1.5	10110144

CR RAL boje / RAL colours



LNK T račva H 60mm PLASTIFICIRAN / T Module LNK H 60mm PLASTIFICIZED

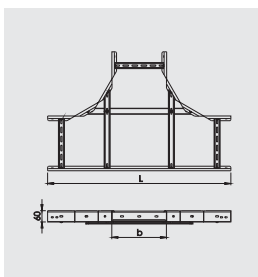

Tip Typ	Širina Width	Visina Height	Debljina Thickness	Sifra artikla Article
T LNK 6 10 CR	100	60	1.5	10110145
T LNK 6 20 CR	200	60	1.5	10110146
T LNK 6 30 CR	300	60	1.5	10110147
T LNK 6 40 CR	400	60	1.5	10110148
T LNK 6 50 CR	500	60	1.5	10110149
T LNK 6 60 CR	600	60	1.5	10110150

CR RAL boje / RAL colours



LNK Bočna spojnica H 60mm PLASTIFICIRAN / Ladder cable trays straight connector H60mm PLASTIFICIZED

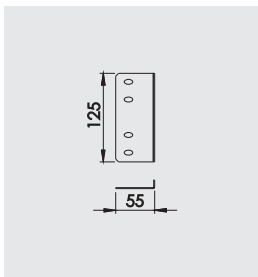

Tip Typ	Širina Width	Visina Height	Debljina Thickness	Sifra artikla Article
S LNK 100 CR	100	60	1.5	10110151

CR RAL boje / RAL colours



Mrežasti nosač kablova MNK L 3000mm PLASTIFICIRAN / Mesh cable trays MNK L 3000mm PLASTIFICIZED

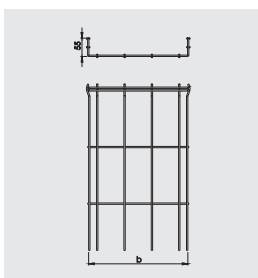

Tip Typ	Širina Width	Visina Height	Debljina žice Wire thickness	Dužina Length	Korisni presek Useful section	Sifra artikla Article
MNK 50/55/3000 CR	50	55	3.9	3000	25	10110152
MNK 100/55/3000 CR	100	55	3.9	3000	50	10110153
MNK 200/55/3000 CR	200	55	3.9	3000	100	10110154
MNK 300/55/3000 CR	300	55	3.9	3000	150	10110155
MNK 400/55/3000 CR	400	55	3.9	3000	200	10110156

CR RAL boje / RAL colours



Žabica MNK regala PLASTIFICIRAN / Toogle Mesh cable trays MNK PLASTIFICIZED

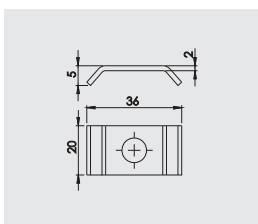

Tip Typ	Širina Width	Visina Height	Debljina Thickness	Sifra artikla Article
ŽMNK 1 CR	20	5	2	10110157

CR RAL boje / RAL colours

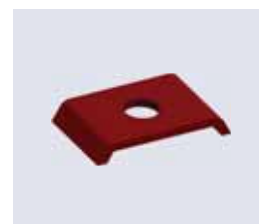

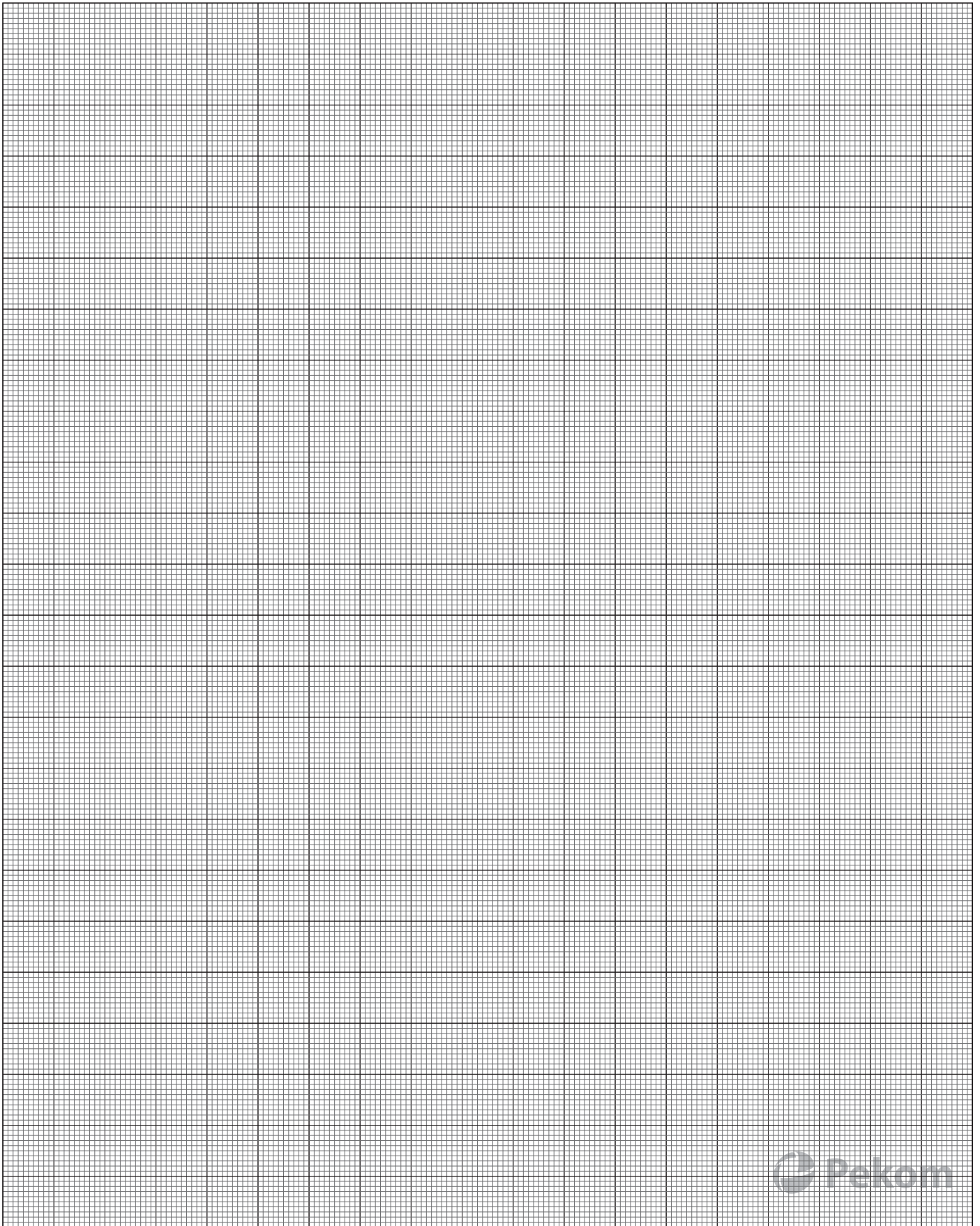

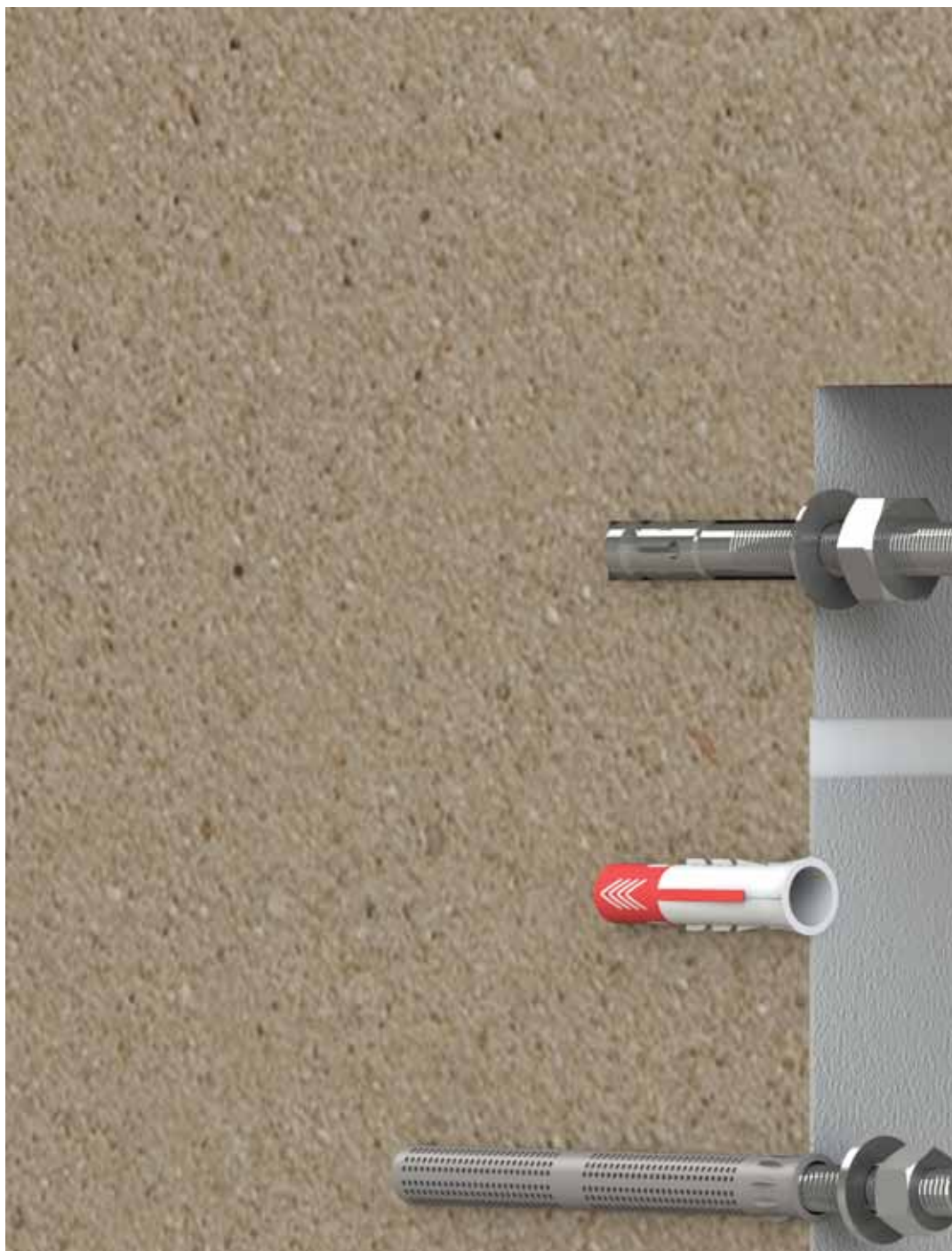

fischer  [®]
innovative solutions



PS

9

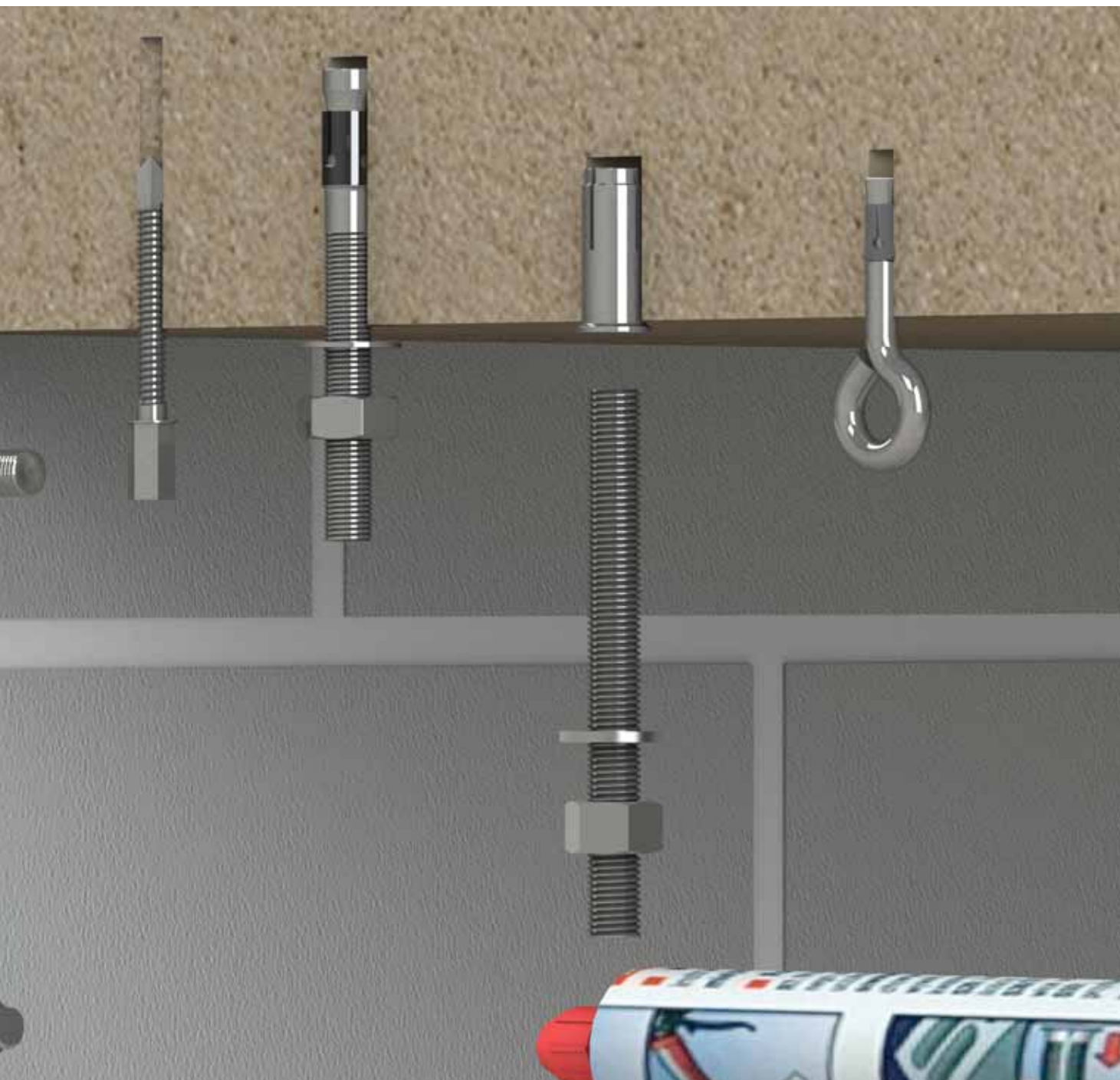

PRIČVRSNI SISTEMI

FASTENING SYSTEMS

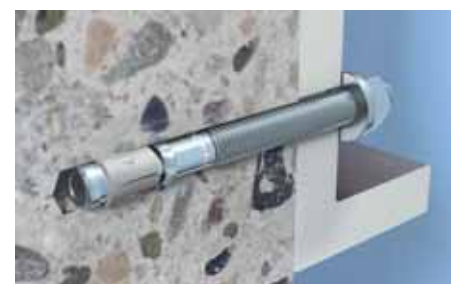
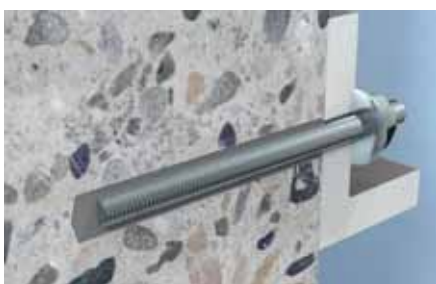

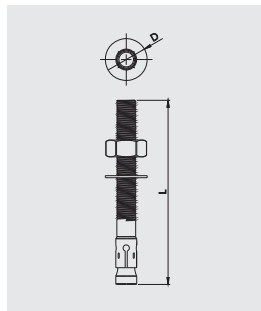
FAZ II anker vijak
PS

Tip Typ	Efek. dubina bušenja Effective depth of drilling	Dužina ankera Anchor length	Maks. korisna dužina Maximum useful length	Pakovanje Pack kom piece	Šifra artikla Article
FAZ II 8/10	45	75	10	50	12000001
FAZ II 8/30		95	30	50	12000002
FAZ II 10/10	60	95	10	50	12000003
FAZ II 10/20		105	20	25	12000004
FAZ II 12/10	70	110	10	20	12000005
FAZ II 12/20		120	20	20	12000006
FAZ II 10/10K	40	75	10	50	12000007
FAZ II 10/30K		85	30	25	12000008
FAZ II 12/10K	50	90	10	20	12000009
FAZ II 12/30K		100	30	20	12000010

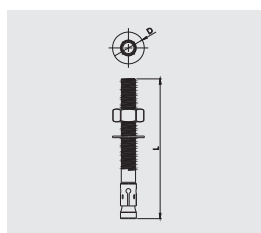
FBN II anker vijak

Tip Typ	Efek. dubina bušenja Effective depth of drilling	Dužina ankera Anchor length	Maks. korisna dužina Maximum useful length	Pakovanje Pack kom piece	Šifra artikla Article
FBN II 8/10	40	71	10	50	12000011
FBN II 8/20		81	20	50	12000012
FBN II 10/10	50	86	10	50	12000013
FBN II 10/20		96	20	50	12000014
FBN II 12/10	65	106	10	20	12000015
FBN II 12/20		116	20	20	12000016

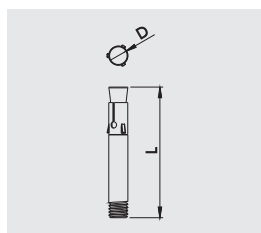
FNA II

Tip Typ	Prečnik burgije Drill diameter	Dubina fiksiranja Fixing depth	Dužina ankera Anchor length	Pakovanje Pack kom piece	Šifra artikla Article
FNA II 6x30 M6	6	30	41	100	12000017

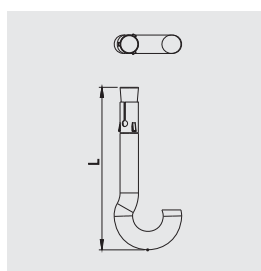
FNA II

Tip Typ	Prečnik burgije Drill diameter	Dubina fiksiranja Fixing depth	Dužina ankera Anchor length	Pakovanje Pack kom piece	Šifra artikla Article
FNA II 6x25 H	6	25	54	50	12000018

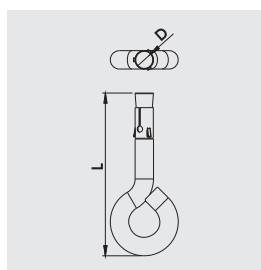

FNA II

Tip Typ	Prečnik burgije Drill diameter	Dubina fiksiranja Fixing depth	Dužina ankera Anchor length	Pakovanje Pack kom piece	Šifra artikla Article
FNA II 6x25 OE	6	25	54	50	12000019

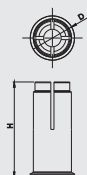

EA II čelični tipli

PS



Tip Typ	Preč. burg. / unutr. navoj Drill diameter / Inner thread	Maks. dubina vijka Max. screw depth	Min. dubina vijka Min. screw depth	Pakovanje Pack kom piece	Šifra artikla Article
EA II M8x30	10 / M8	13	8	100	12000020
EA II M10x40	12 / M10	17	10	50	12000021
EA II M12x50	15 / M12	22	12	25	12000022



EA N čelični tipli



Tip Typ	Preč. burg. / unutr. navoj Drill diameter / Inner thread	Maks. dubina vijka Max. screw depth	Min. dubina vijka Min. screw depth	Pakovanje Pack kom piece	Šifra artikla Article
EA N M8x30	10 / M8	13	8	100	12000023
EA N M10x40	12 / M10	17	10	50	12000024
EA N M12x50	14 / M12	22	12	50	12000025



FHY čelični tipli



Tip Typ	Preč. burg. / unutr. navoj Drill diameter / Inner thread	Dužina vijka Screw length	Min. debljina betona Min. thickness of concrete	Pakovanje Pack kom piece	Šifra artikla Article
FHY M8	12 / M8	43	25	25	12000026
FHY M10	16 / M10	52	30	20	12000027



FBS samourezujući vijak za beton

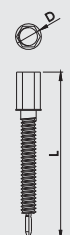

Tip Typ	Prečnik burgije Drill diameter	Prihvat	Dužina ankera Anchor length	Pakovanje Pack kom piece	Šifra artikla Article
FBS 6x35 M8/M10	6	SW 13	72	100	12000028
FBS 6x55 M8/M10	6	SW 13	83	100	12000029



FBS samourezujući vijak za beton

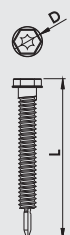

Tip Typ	Prečnik burgije Drill diameter	Prihvat	Dužina ankera Anchor length	Pakovanje Pack kom piece	Šifra artikla Article
FBS 6x40/5 US	6	SW 13 / T30	40	100	12000030

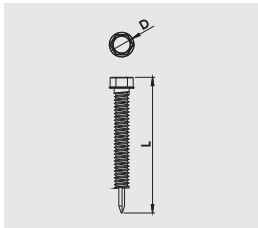

FBS samourezujući vijak za beton
PS

Tip Typ	Prečnik burgije Drill diameter	Prihvata Load capacity	Dužina ankera Anchor length	Pakovanje Pack kom piece	Šifra artikla Article
FBS 8x80/15 US	8 mm	SW 13	80 mm	50	12000031

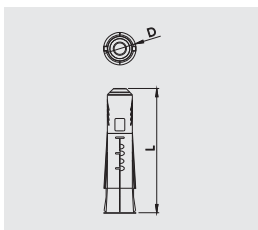
DUOPOWER tipli

Tip Typ	Vijak Screw	Pakovanje Pack kom piece	Šifra artikla Article
Duopower 6x30	6 mm	100	12000032
Duopower 8x40	8 mm	100	12000033
Duopower 10x50	10 mm	50	12000034
Duopower 12x60	12 mm	25	12000035

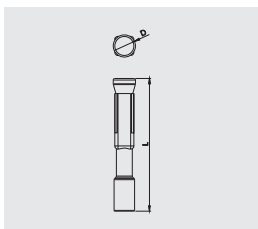
FPX čelični tipli za siporeks (gas beton)

Tip Typ	Prečnik burgije Drill diameter	Dužina ankera Anchor length	Min. dubina otvora Min. depth of the hole	Pakovanje Pack kom piece	Šifra artikla Article
FPX M8	10 mm	75 mm	95 mm	25	12000036
FPX M10	10 mm	75 mm	95 mm	25	12000037
FPX M12	10 mm	75 mm	95 mm	25	12000038

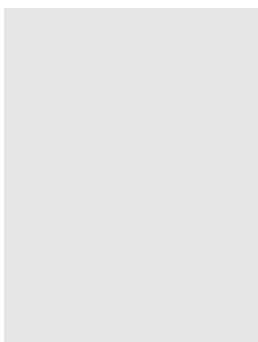
FIS V300T smesa za hemijsko fiksiranje u svim materijalima

FIS V300T	ZA ISTISKIVANJE POTREBAN JE PIŠTOLJ ZA SILICON. UZ SVAKI PATRON SE DOBIJAJU PO 2 KOMADA MEŠAČA.				
-----------	---	--	--	--	--

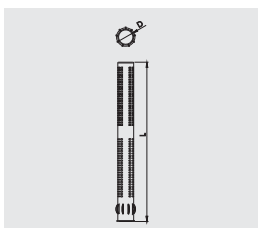
FIS H

FIS H12x85K FIS H16x85K	Plastični uložak za hemijsko fiksiranje u šupljem bloku	za navojnu šipku M6-M8 za navojnu šipku M8-M10
----------------------------	---	---



PBZ

PS



PBZ	Plastični uložak za hemijsko fiksiranje u gasbetonu (siporeksu)	za navojnu šipku M8-M12
------------	---	-------------------------



SX tipli plastični, gužvujući u 4 pravca



Tip Typ	Vijak Screw	Pakovanje Pack kom piece	Šifra artikla Article
SX 6x30	mm 4 - 5	100	12000039
SX 8x40	4,5 - 6	100	12000040
SX 10x50	6 - 8	50	12000041
SX 12x60	8 - 10	25	12000042



N tipli plastični sa vijkom (ukucavajući)

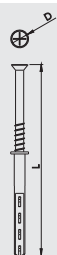

Tip Typ	Dubina fiksiranja Fixing depth	Pakovanje Pack kom piece	Šifra artikla Article
N 6x40 F	mm 35	100	12000043
N 6x60 F	35	100	12000044



TKL stega montažna

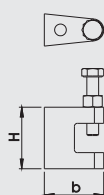

Tip Typ	Otvor stega Opening of the clamp	Preporučeno opterećenje Recommended load	Pakovanje Pack kom piece	Šifra artikla Article
TKL L M8	mm 0-18	kN 1.2	50	12000045
TKL M10	0-20	2.5	50	12000046
TKL M12	0-26	3.5	50	12000047



TKR nosač profila

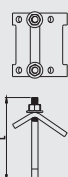

Tip Typ	Navoj Thread	Širina otvora na nosaču Broadness of the hole on the carrier	Pakovanje Pack kom piece	Šifra artikla Article
TKR 27	mm M6	mm 29	25	12000048
TKR 41	M8	45	20	12000049
TKL 82	M10	45	20	12000050



AG vijak sa oknom

PS

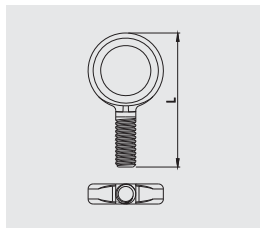

Tip Typ	Otvor Hole	Pakovanje Pack kom piece	Šifra artikla Article
AG 8x25	mm 8.5	25	12000051
AG 10x25	10.5	25	12000052



TKL navrtka sa oknom

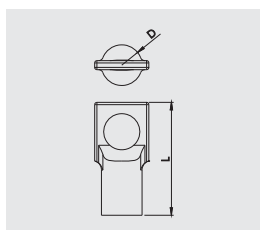

Tip Typ	Otvor Hole	Pakovanje Pack kom piece	Šifra artikla Article
RAH M8	mm 12	50	12000053
RAH M10	12	50	12000054



Obujmica za fiksiranje kablova

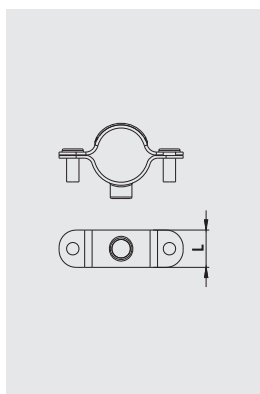

Tip Typ	Pakovanje Pack kom piece	Šifra artikla Article
AM8	50	12000055
AM10	50	12000056
AM12	50	12000057
AM14	50	12000058
AM15/16	50	12000059
AM18	50	12000060
AM20	50	12000061
AM22	50	12000062
AM24	50	12000063
AM25/26	50	12000064
AM28	50	12000065
AM30	50	12000066
AM32	25	12000067
AM34	25	12000068



Navojna šipka / Threaded rod

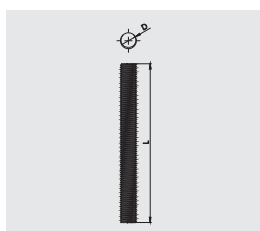

Tip Typ	Dužina Length	Prečnik Diameter	Pakovanje Pack kom piece	Šifra artikla Article
PEKOM Navojna šipka M8	mm 3000	mm 8	10	12000069
PEKOM Navojna šipka M10	3000	10	10	12000070
PEKOM Navojna šipka M12	3000	12	10	12000071



Nazubljena matica / Hex flange nut

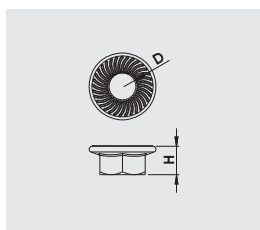



Tip Typ	Prečnik Diameter	Pakovanje Pack kom piece	Šifra artikla Article
PEKOM Nazubljena matica M6	mm 6	400	12000072
PEKOM Nazubljena matica M8	8	400	12000073



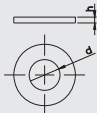

Podloška / Washer

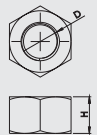

PS

	Tip Typ	Prečnik Diameter	Pakovanje Pack kom piece	Šifra artikla Article	
		mm			
	PEKOM Podloška M8	8	400	12000074	
	PEKOM Podloška M10	10	400	12000075	
	PEKOM Podloška M12	12	400	12000076	

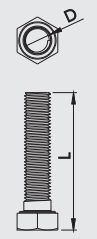

Matica / Nut

	Tip Typ	Prečnik Diameter	Pakovanje Pack kom piece	Šifra artikla Article	
		mm			
	PEKOM Matica M8	8	400	12000077	
	PEKOM Matica M10	10	400	12000078	
	PEKOM Matica M12	12	400	12000079	



Vijak sa šestougaonom glavom / Hex bolt

	Tip Typ	Dužina Lenght	Šifra artikla Article	
		mm		
	PEKOM Vijak M8	20	12000080	
	PEKOM Vijak M8	25	12000081	
	PEKOM Vijak M8	30	12000082	
	PEKOM Vijak M10	20	12000083	
	PEKOM Vijak M10	30	12000084	
	PEKOM Vijak M10	40	12000085	
	PEKOM Vijak M10	50	12000086	
	PEKOM Vijak M10	80	12000087	
	PEKOM Vijak M10	90	12000088	
	PEKOM Vijak M12	30	12000089	
	PEKOM Vijak M12	40	12000090	
	PEKOM Vijak M12	50	12000091	

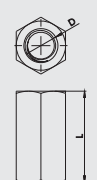

Torban vijak / Carriage bolt

	Tip Typ	Dužina Lenght	Prečnik Diameter	Pakovanje Pack kom piece	Šifra artikla Article	
		mm	mm			
	Torban vijak M6	12	6	250	12000092	
	Torban vijak M8	16	8	250	12000093	

MUF / Muff with transverse inner thread

	Tip Typ	Prečnik Diameter	Pakovanje Pack kom piece	Šifra artikla Article	
		mm			
	Muf M8	8	100	12000094	
	Muf M10	10	100	12000095	
	Muf M12	12	100	12000096	

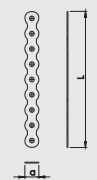
Perforirana traka / Perforated strip

	Tip Typ	Dužina L Length L	Otvor Hole	Debljina Thickness	Pakovanje Pack kom piece	Šifra artikla Article	
		mm	mm	mm			
	PEKOM T6	3000	6.2	0.75	10	12000097	
	PEKOM T8	3000	8.2	0.75	10	12000098	

PL Pocinkovani lim / Galvanized sheet

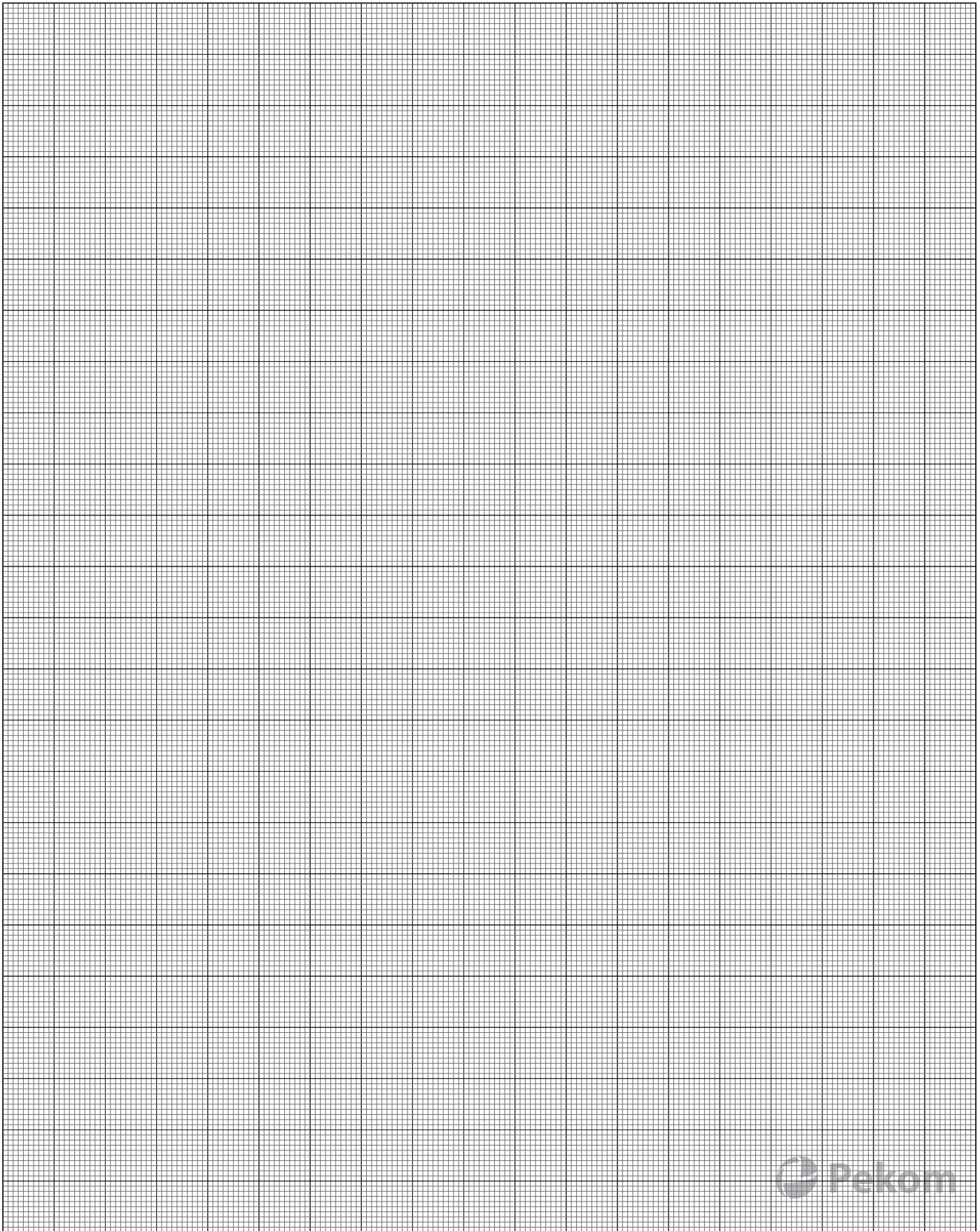

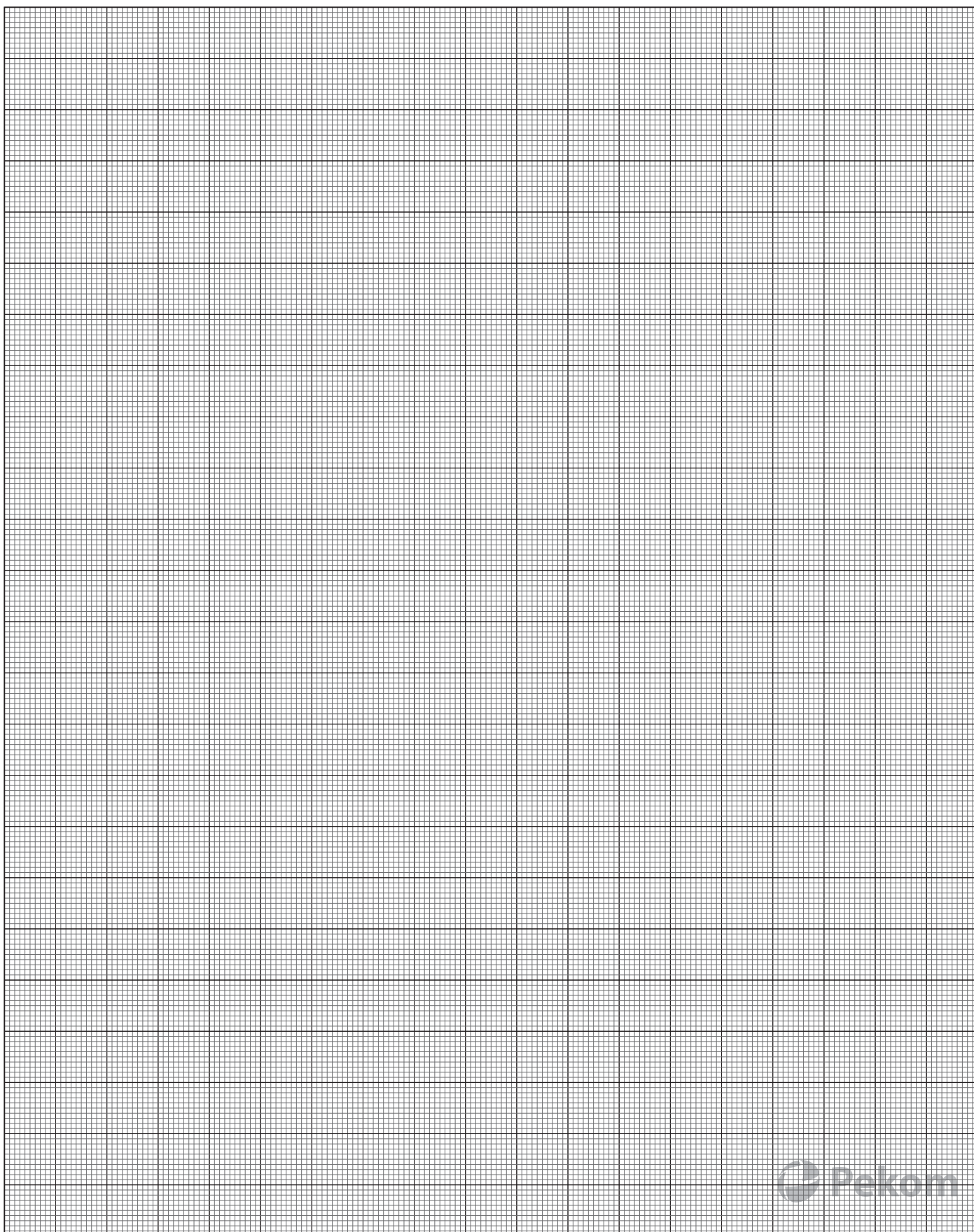

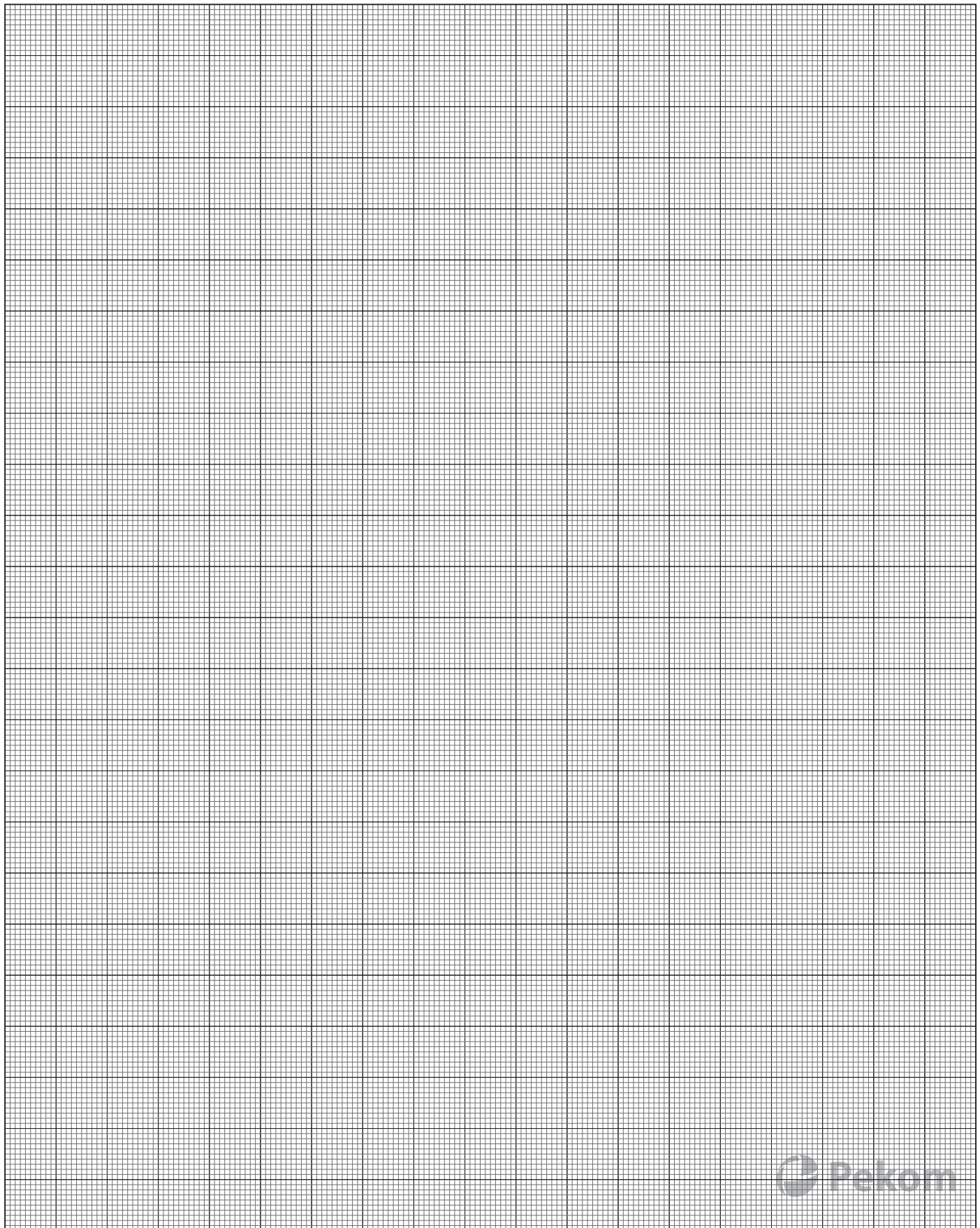

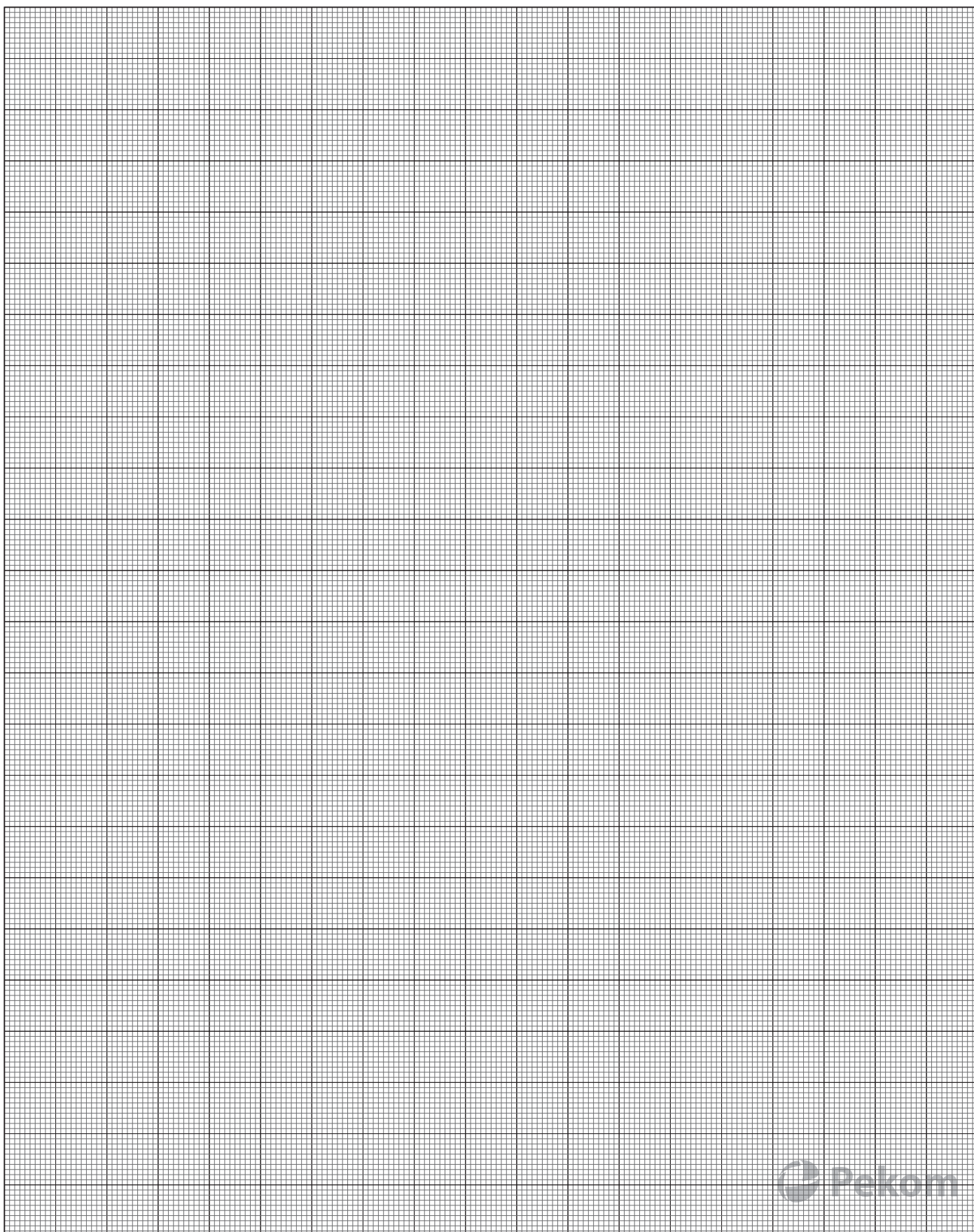

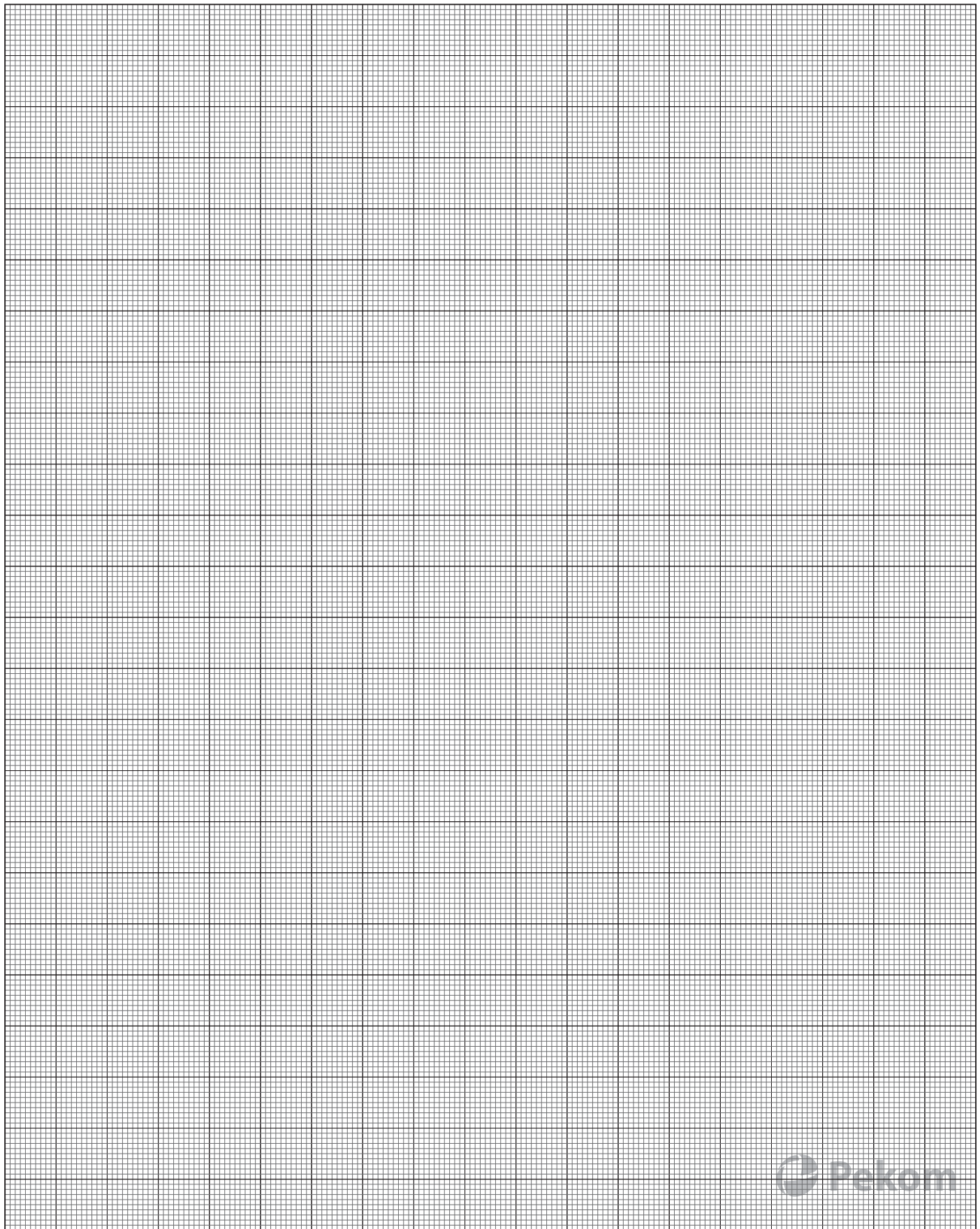

Declaration on Conformity

Producer: Pekom Inženjering
Address: Jozanička 77, 36000 Kraljevo, Republic of Serbia

Product: Trays PNK, Lion honor trays RNK/ Med-cable trays MNK
Model: PNK 50... PNK 800, RNK 50... RNK 800, MNK 50... 600, PNK 50 E90... PNK 600 E90

Type: Fire-proof trays type E90, tray of PNK zinc coated by dipping trays

Purpose: Distribution of cable installations

Dimensions: 0n thickness 0,75 mm zinc coated, wire of diameter 3,9 and 3 mm
Surface protection: Electrolytically zinc coated by dipping, inox, plastic

The producer here within declares, under full responsibility that above stated product fulfils applicable requirements of the following Directive of the European Parliament and Council / Relevant Rules of the Republic of Serbia:

DIRECTIVE 2006/95/EC EUROPEAN PARLIAMENT AND COUNCIL on 12th December 2006 on Harmonization of Legislation of Member States concerning electrical equipment meant for use within the frame of certain stress borders (Official Register RS number 13/10) and harmonized Serbian standards which were in accordance with European standards.

SRPS EN 61537:2009 cable management - Systems of cable shelves and systems of cable ladders / Identical to EN 61537:2007

DIN 4102-12 Behaviour of construction material and elements at presence of fire - Part 12: resistance of electrical cable systems necessary for maintenance of circuits integrity - demands and testing

Testing report: report on testing GFT - 5210/15-OPZ IMS Beograd, 612-22-031/16, 612-22-036/16, 612-22-173/15, 612-22-63/16, University of NiS, 13-1375/3, 13-1375/4, 13-1375/5 Institute 10 May NiS

October, 2015
Kraljevo, Republic of Serbia

Person in charge
Marko Peković, manager

Deklaracija o Usaglašenosti

Proizvođač: Pekom Inženjering
Adresa: Jozanička 77, 36000 Kraljevo, Republika Srbija

Proizvod: Nosaci kablova PNK, Lestnice nosaci kablova RNK, Medzati nosaci kablova MNK
Model: PNK 50... PNK 800, RNK 50... RNK 800, MNK 50... 600, PNK 50 E90... PNK 600 E90

Tip: Vatrootporni nosaci kablova tipe E90, Nosaci kablova od PNK - a, toplogalvanizovani (potapanjem) nosaci kablova

Namena: Razvod kablovskih instalacija

Dimenzije: 0n debljine 0,75 - 1,5 mm hladno pocinkovani, žica prečnika 3,9 i 3 mm
Površinska zaštita: Galvanski pocinkovano, toplogalvanizovano potapanjem, inox, plastificirani

Proizvođač izjavljuje pod punom odgovornošću da gore navedeni proizvod ispunjava sve primenljive zahtevе sledećih direktiva Evropskog Parlamenta i Veća / Relevantnih pravilnika Republike Srbije:

DIREKTIVA 2006/95/EZ EUROPSKOG PARLAMENTA I VEĆA od 12. Decembra 2006. o usklađivanju zakonodavstva država članica u odnosu na električnu opremu namenjenu za upotrebu u okviru određenih naponskih granica / Praviilnik o električnoj opremi namenjnoj za upotrebu u okviru određenih granica napona („Službeni glasnik RS“, broj 13/10.) harmonizovanih Srpskih standarda kojima su prezenti Evropski standardi.

SRPS EN 61537:2009 Vođenje kablova - Sistemi kablovskih guloica i sistemi kablovskih lestvi / Identična sa EN 61537:2007

DIN 4102-12 Ponašanje građevinskog materijala i elemenata u prisustvu vatre - Dio 12: Otpornost električnih kablovskih sistema potrebnih za održavanje integriteta kula - Zahtevi i testiranje

Izveštaj ispitivanja: Izveštaj o ispitivanju GFT - 5210/15-OPZ IMS Beograd, 612-22-031/16, 612-22-036/16, 612-22-173/15, 612-22-63/16 Univerzitet u Nišu, 13-1375/3, 13-1375/4, 13-1375/5 Institut 1. Maj NiS.

Oktober, 2015. g.
Kraljevo, Republika Srbije

Odgovorna osoba:
Marko Peković, direktor

ZERTIFIKAT ♦ CERTIFICATE ♦ CERTIFICADO ♦ СЕРТИФИКАТ ♦ CERTIFICADO ♦ CERTIFICAT

CERTIFICATE

The Certification Body of TÜV SÜD Management Service GmbH certifies that

PEKOM INŽENJERING d.o.o.
 Jozanička 77
 36000 Kraljevo
 Serbia

has established and applies a Quality Management System for

Production and sale of cable support systems.

An audit was performed, Report No. 787058340.
 Proof has been furnished that the requirements according to

ISO 9001:2008

are fulfilled.

This certificate is valid from 2016-04-25 until 2018-09-14.
 Certificate Registration No.: 12 100 51917 TMS.

TÜV SÜD Management Service GmbH • Zentralfriedhofstraße • 80339 München • Germany

ZERTIFIKAT ♦ CERTIFICATE ♦ CERTIFICADO ♦ СЕРТИФИКАТ ♦ CERTIFICADO ♦ CERTIFICAT

SERTIFIKAT

Sertifikaciono telo TÜV SÜD Management Service GmbH potvrđuje da

PEKOM INŽENJERING d.o.o.
 Jozanička 77
 36000 Kraljevo
 Srbija

je ustanovilo i primenjuje sistem upravljanja kvalitetom.

Proverom kvaliteta, izveštaj broj 787058340, potvrđeno je da su ispunjeni zahtevi prema standardu

ISO 9001:2008.

Ovaj sertifikat važi od 2016-04-25 do 2018-09-14.
 Registracioni broj sertifikata: 12 100 51917 TMS.

TÜV SÜD Management Service GmbH • Zentralfriedhofstraße • 80339 München • Germany

www.pekom.rs